

Q. 1 – Q. 5 carry one mark each.

Q.1 The lecture was attended by quite _____ students, so the hall was not very _____.

- (A) a few, quite (B) few, quiet (C) a few, quiet (D) few, quite

Q.2 They have come a long way in _____ trust among the users.

- (A) creating (B) created (C) creation (D) create

Q.3 On a horizontal ground, the base of a straight ladder is 6 m away from the base of a vertical pole. The ladder makes an angle of 45° to the horizontal. If the ladder is resting at a point located at one-fifth of the height of the pole from the bottom, the height of the pole is _____ meters.

- (A) 15 (B) 25 (C) 30 (D) 35

Q.4 If $E = 10$; $J = 20$; $O = 30$; and $T = 40$, what will be $P + E + S + T$?

- (A) 51 (B) 82 (C) 120 (D) 164

Q.5 The CEO's decision to quit was as shocking to the Board as it was to _____.

- (A) I (B) me (C) my (D) myself

Q. 6 – Q. 10 carry two marks each.

Q.6 The new cotton technology, Bollgard-II, with herbicide tolerant traits has developed into a thriving business in India. However, the commercial use of this technology is not legal in India. Notwithstanding that, reports indicate that the herbicide tolerant Bt cotton had been purchased by farmers at an average of Rs 200 more than the control price of ordinary cotton, and planted in 15% of the cotton growing area in the 2017 Kharif season.

Which one of the following statements can be inferred from the given passage?

- (A) Farmers want to access the new technology if India benefits from it
- (B) Farmers want to access the new technology even if it is not legal
- (C) Farmers want to access the new technology for experimental purposes
- (D) Farmers want to access the new technology by paying high price

Q.7 In a sports academy of 300 people, 105 play only cricket, 70 play only hockey, 50 play only football, 25 play both cricket and hockey, 15 play both hockey and football and 30 play both cricket and football. The rest of them play all three sports. What is the percentage of people who play at least two sports?

- (A) 23.30 (B) 25.00 (C) 28.00 (D) 50.00

Q.8 “The increasing interest in tribal characters might be a mere coincidence, but the timing is of interest. None of this, though, is to say that the tribal hero has arrived in Hindi cinema, or that the new crop of characters represents the acceptance of the tribal character in the industry. The films and characters are too few to be described as a pattern.”

What does the word ‘arrived’ mean in the paragraph above?

- (A) reached a terminus
- (B) came to a conclusion
- (C) attained a status
- (D) went to a place

Q.9 A square has sides 5 cm smaller than the sides of a second square. The area of the larger square is four times the area of the smaller square. The side of the larger square is _____ cm.

- (A) 18.50 (B) 15.10 (C) 10.00 (D) 8.50

Q.10 P, Q, R, S and T are related and belong to the same family. P is the brother of S. Q is the wife of P. R and T are the children of the siblings P and S respectively. Which one of the following statements is necessarily FALSE?

- (A) S is the aunt of R
- (B) S is the aunt of T
- (C) S is the sister-in-law of Q
- (D) S is the brother of P

END OF THE QUESTION PAPER

Q. 1 – Q. 25 carry one mark each.

Q.1 Which one of the following is correct?

- (A) $\lim_{x \rightarrow 0} \left(\frac{\sin 4x}{\sin 2x} \right) = 2$ and $\lim_{x \rightarrow 0} \left(\frac{\tan x}{x} \right) = 1$
 (B) $\lim_{x \rightarrow 0} \left(\frac{\sin 4x}{\sin 2x} \right) = 1$ and $\lim_{x \rightarrow 0} \left(\frac{\tan x}{x} \right) = 1$
 (C) $\lim_{x \rightarrow 0} \left(\frac{\sin 4x}{\sin 2x} \right) = \infty$ and $\lim_{x \rightarrow 0} \left(\frac{\tan x}{x} \right) = 1$
 (D) $\lim_{x \rightarrow 0} \left(\frac{\sin 4x}{\sin 2x} \right) = 2$ and $\lim_{x \rightarrow 0} \left(\frac{\tan x}{x} \right) = \infty$

Q.2 Consider a two-dimensional flow through isotropic soil along x direction and z direction. If h is the hydraulic head, the Laplace's equation of continuity is expressed as

- (A) $\frac{\partial h}{\partial x} + \frac{\partial h}{\partial z} = 0$ (B) $\frac{\partial h}{\partial x} + \frac{\partial h}{\partial x} \frac{\partial h}{\partial z} + \frac{\partial h}{\partial z} = 0$
 (C) $\frac{\partial^2 h}{\partial x^2} + \frac{\partial^2 h}{\partial z^2} = 0$ (D) $\frac{\partial^2 h}{\partial x^2} + \frac{\partial^2 h}{\partial x \partial z} + \frac{\partial^2 h}{\partial z^2} = 0$

Q.3 A simple mass-spring oscillatory system consists of a mass m , suspended from a spring of stiffness k . Considering z as the displacement of the system at any time t , the equation of motion for the free vibration of the system is $m\ddot{z} + kz = 0$. The natural frequency of the system is

- (A) $\frac{k}{m}$ (B) $\sqrt{\frac{k}{m}}$ (C) $\frac{m}{k}$ (D) $\sqrt{\frac{m}{k}}$

Q.4 For a small value of h , the Taylor series expansion for $f(x+h)$ is

- (A) $f(x) + hf'(x) + \frac{h^2}{2!} f''(x) + \frac{h^3}{3!} f'''(x) + \dots \infty$
 (B) $f(x) - hf'(x) + \frac{h^2}{2!} f''(x) - \frac{h^3}{3!} f'''(x) + \dots \infty$
 (C) $f(x) + hf'(x) + \frac{h^2}{2} f''(x) + \frac{h^3}{3} f'''(x) + \dots \infty$
 (D) $f(x) - hf'(x) + \frac{h^2}{2} f''(x) - \frac{h^3}{3} f'''(x) + \dots \infty$

Q.5 A plane truss is shown in the figure (*not drawn to scale*).

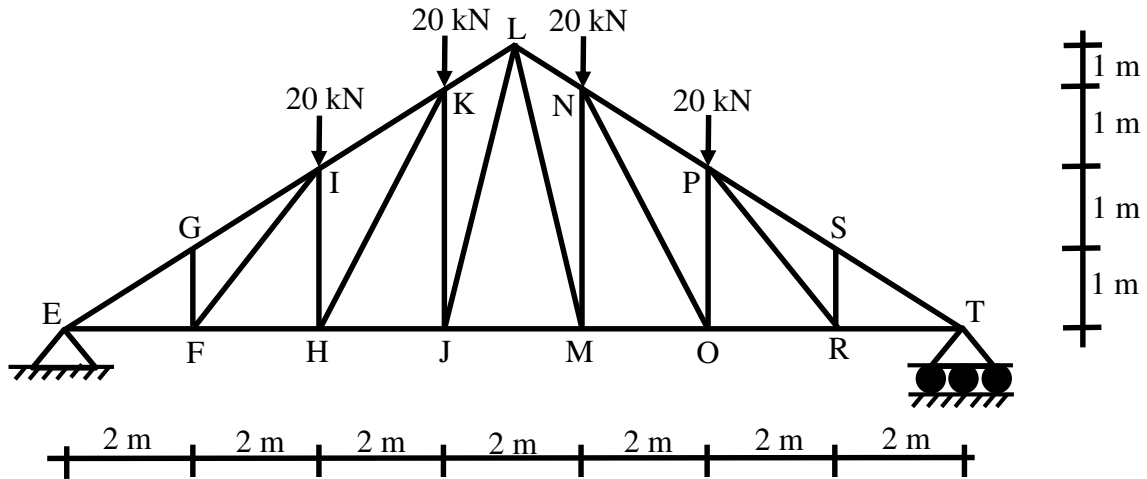

Which one of the options contains ONLY zero force members in the truss?

- (A) FG, FI, HI, RS
- (B) FG, FH, HI, RS
- (C) FI, HI, PR, RS
- (D) FI, FG, RS, PR

Q.6 An element is subjected to biaxial normal tensile strains of 0.0030 and 0.0020. The normal strain in the plane of maximum shear strain is

- (A) Zero
- (B) 0.0010
- (C) 0.0025
- (D) 0.0050

Q.7 Consider the pin-jointed plane truss shown in the figure (*not drawn to scale*). Let R_P , R_Q , and R_R denote the vertical reactions (upward positive) applied by the supports at P, Q, and R, respectively, on the truss. The correct combination of (R_P, R_Q, R_R) is represented by

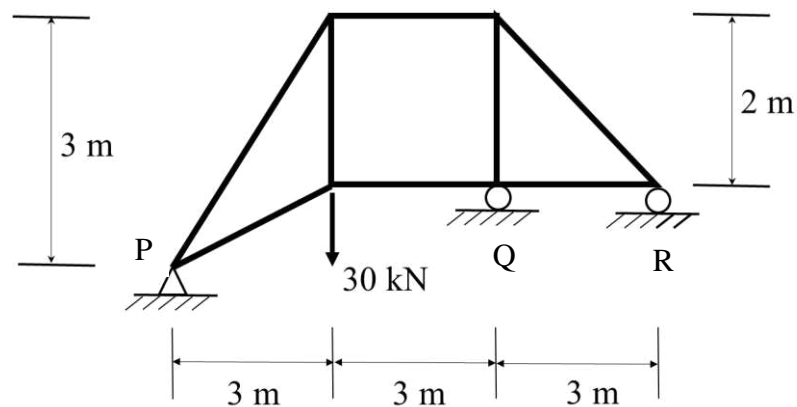

- (A) (30, -30, 30) kN
- (B) (20, 0, 10) kN
- (C) (10, 30, -10) kN
- (D) (0, 60, -30) kN

- Q.8 Assuming that there is no possibility of shear buckling in the web, the maximum reduction permitted by IS 800-2007 in the (low-shear) design bending strength of a semi-compact steel section due to high shear is
- (A) zero (B) 25%
(C) 50% (D) governed by the area of the flange
- Q.9 In the reinforced beam section shown in the figure (*not drawn to scale*), the nominal cover provided at the bottom of the beam as per IS 456-2000, is

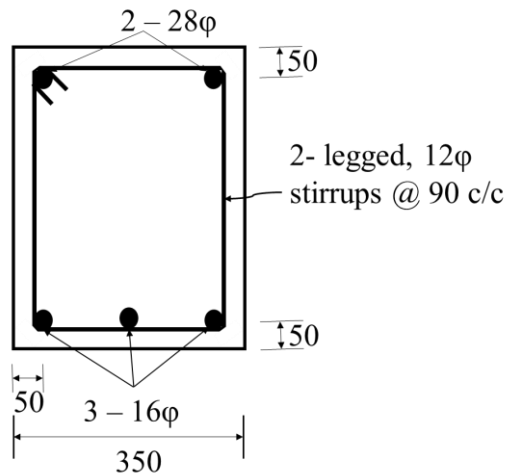

All dimensions are in mm

- (A) 30 mm (B) 36 mm
(C) 42 mm (D) 50 mm
- Q.10 The interior angles of four triangles are given below:

Triangle	Interior Angles
P	$85^\circ, 50^\circ, 45^\circ$
Q	$100^\circ, 55^\circ, 25^\circ$
R	$100^\circ, 45^\circ, 35^\circ$
S	$130^\circ, 30^\circ, 20^\circ$

Which of the triangles are ill-conditioned and should be avoided in Triangulation surveys?

- (A) Both P and R
(B) Both Q and R
(C) Both P and S
(D) Both Q and S

- Q.11 The coefficient of average rolling friction of a road is f_r and its grade is $+G\%$. If the grade of this road is doubled, what will be the percentage change in the braking distance (for the design vehicle to come to a stop) measured along the horizontal (assume all other parameters are kept unchanged)?
- (A) $\frac{0.01 G}{f_r+0.02 G} \times 100$ (B) $\frac{f_r}{f_r+0.02 G} \times 100$
 (C) $\frac{0.02 G}{f_r+0.01 G} \times 100$ (D) $\frac{2f_r}{f_r+0.01 G} \times 100$
- Q.12 An isolated concrete pavement slab of length L is resting on a frictionless base. The temperature of the top and bottom fibre of the slab are T_t and T_b , respectively. Given: the coefficient of thermal expansion = α and the elastic modulus = E . Assuming $T_t > T_b$ and the unit weight of concrete as zero, the maximum thermal stress is calculated as
- (A) $L\alpha(T_t - T_b)$
 (B) $E\alpha(T_t - T_b)$
 (C) $\frac{E\alpha(T_t - T_b)}{2}$
 (D) zero
- Q.13 In a rectangular channel, the ratio of the velocity head to the flow depth for critical flow condition, is
- (A) $\frac{1}{2}$ (B) $\frac{2}{3}$ (C) $\frac{3}{2}$ (D) 2
- Q.14 If the path of an irrigation canal is below the bed level of a natural stream, the type of cross-drainage structure provided is
- (A) Aqueduct (B) Level crossing (C) Sluice gate (D) Super passage
- Q.15 A catchment may be idealised as a rectangle. There are three rain gauges located inside the catchment at arbitrary locations. The average precipitation over the catchment is estimated by two methods: (i) Arithmetic mean (P_A), and (ii) Thiessen polygon (P_T). Which one of the following statements is correct?
- (A) P_A is always smaller than P_T
 (B) P_A is always greater than P_T
 (C) P_A is always equal to P_T
 (D) There is no definite relationship between P_A and P_T

- Q.16 A retaining wall of height H with smooth vertical backface supports a backfill inclined at an angle β with the horizontal. The backfill consists of cohesionless soil having angle of internal friction ϕ . If the active lateral thrust acting on the wall is P_a , which one of the following statements is TRUE?
- (A) P_a acts at a height $H/2$ from the base of the wall and at an angle β with the horizontal
(B) P_a acts at a height $H/2$ from the base of the wall and at an angle ϕ with the horizontal
(C) P_a acts at a height $H/3$ from the base of the wall and at an angle β with the horizontal
(D) P_a acts at a height $H/3$ from the base of the wall and at an angle ϕ with the horizontal
- Q.17 In a soil specimen, the total stress, effective stress, hydraulic gradient and critical hydraulic gradient are σ , σ' , i and i_c , respectively. For initiation of quicksand condition, which one of the following statements is TRUE?
- (A) $\sigma' \neq 0$ and $i = i_c$ (B) $\sigma' = 0$ and $i = i_c$
(C) $\sigma' \neq 0$ and $i \neq i_c$ (D) $\sigma = 0$ and $i = i_c$
- Q.18 Which one of the following is a secondary pollutant?
- (A) Ozone
(B) Carbon Monoxide
(C) Hydrocarbon
(D) Volatile Organic Carbon (VOC)
- Q.19 For a given loading on a rectangular plain concrete beam with an overall depth of 500 mm, the compressive strain and tensile strain developed at the extreme fibers are of the same magnitude of 2.5×10^{-4} . The curvature in the beam cross-section (in m^{-1} , round off to 3 decimal places), is _____
- Q.20 A completely mixed dilute suspension of sand particles having diameters 0.25, 0.35, 0.40, 0.45 and 0.50 mm are filled in a transparent glass column of diameter 10 cm and height 2.50 m. The suspension is allowed to settle without any disturbance. It is observed that all particles of diameter 0.35 mm settle to the bottom of the column in 30 s. For the same period of 30 s, the percentage removal (round off to integer value) of particles of diameters 0.45 and 0.50 mm from the suspension is _____
- Q.21 The maximum number of vehicles observed in any five minute period during the peak hour is 160. If the total flow in the peak hour is 1000 vehicles, the five minute peak hour factor (round off to 2 decimal places) is _____

- Q.22 A circular duct carrying water gradually contracts from a diameter of 30 cm to 15 cm. The figure (not drawn to scale) shows the arrangement of differential manometer attached to the duct.

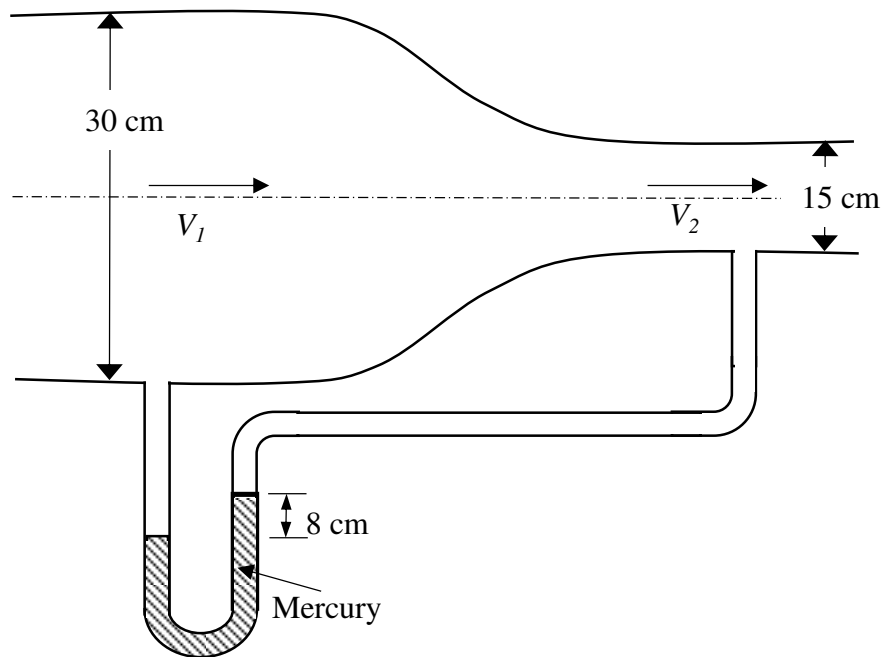

- When the water flows, the differential manometer shows a deflection of 8 cm of mercury (Hg). The values of specific gravity of mercury and water are 13.6 and 1.0, respectively. Consider the acceleration due to gravity, $g = 9.81 \text{ m/s}^2$. Assuming frictionless flow, the flow rate (in m^3/s , round off to 3 decimal places) through the duct is _____
- Q.23 The probability that the annual maximum flood discharge will exceed 25000 m^3/s , at least once in next 5 years is found to be 0.25. The return period of this flood event (in years, round off to 1 decimal place) is _____
- Q.24 A soil has specific gravity of its solids equal to 2.65. The mass density of water is 1000 kg/m^3 . Considering zero air voids and 10% moisture content of the soil sample, the dry density (in kg/m^3 , round off to 1 decimal place) would be _____
- Q.25 A concentrated load of 500 kN is applied on an elastic half space. The ratio of the increase in vertical normal stress at depths of 2 m and 4 m along the point of the loading, as per Boussinesq's theory, would be _____

Q. 26 – Q. 55 carry two marks each.

Q.26 Which one of the following is NOT a correct statement?

- (A) The function $\sqrt[x]{x}$, ($x > 0$), has the global maxima at $x = e$
- (B) The function $\sqrt[x]{x}$, ($x > 0$), has the global minima at $x = e$
- (C) The function x^3 has neither global minima nor global maxima
- (D) The function $|x|$ has the global minima at $x = 0$

Q.27 A one-dimensional domain is discretized into N sub-domains of width Δx with node numbers $i = 0, 1, 2, 3, \dots, N$. If the time scale is discretized in steps of Δt , the forward-time and centered-space finite difference approximation at i^{th} node and n^{th} time step, for the partial differential

equation $\frac{\partial v}{\partial t} = \beta \frac{\partial^2 v}{\partial x^2}$ is

$$(A) \frac{v_i^{(n+1)} - v_i^{(n)}}{\Delta t} = \beta \left[\frac{v_{i+1}^{(n)} - 2v_i^{(n)} + v_{i-1}^{(n)}}{(\Delta x)^2} \right]$$

$$(B) \frac{v_{i+1}^{(n+1)} - v_i^{(n)}}{\Delta t} = \beta \left[\frac{v_{i+1}^{(n)} - 2v_i^{(n)} + v_{i-1}^{(n)}}{2\Delta x} \right]$$

$$(C) \frac{v_i^{(n)} - v_i^{(n-1)}}{\Delta t} = \beta \left[\frac{v_{i+1}^{(n)} - 2v_i^{(n)} + v_{i-1}^{(n)}}{(\Delta x)^2} \right]$$

$$(D) \frac{v_i^{(n)} - v_i^{(n-1)}}{2\Delta t} = \beta \left[\frac{v_{i+1}^{(n)} - 2v_i^{(n)} + v_{i-1}^{(n)}}{2\Delta x} \right]$$

Q.28 A rectangular open channel has a width of 5 m and a bed slope of 0.001. For a uniform flow of depth 2 m, the velocity is 2 m/s. The Manning's roughness coefficient for the channel is

- (A) 0.002
- (B) 0.017
- (C) 0.033
- (D) 0.050

Q.29 For the following statements:

- P – The lateral stress in the soil while being tested in an oedometer is always at-rest.
- Q – For a perfectly rigid strip footing at deeper depths in a sand deposit, the vertical normal contact stress at the footing edge is greater than that at its centre.
- R – The corrections for overburden pressure and dilatancy are not applied to measured SPT- N values in case of clay deposits.

The correct combination of the statements is

- (A) P – TRUE; Q – TRUE; R – TRUE
- (B) P – FALSE; Q – FALSE; R – TRUE
- (C) P – TRUE; Q – TRUE; R – FALSE
- (D) P – FALSE; Q – FALSE; R – FALSE

Q.30 Consider two functions: $x = \psi \ln \phi$ and $y = \phi \ln \psi$. Which one of the following is the correct expression for $\frac{\partial \psi}{\partial x}$?

- (A) $\frac{x \ln \psi}{\ln \phi \ln \psi - 1}$
- (B) $\frac{x \ln \phi}{\ln \phi \ln \psi - 1}$
- (C) $\frac{\ln \phi}{\ln \phi \ln \psi - 1}$
- (D) $\frac{\ln \psi}{\ln \phi \ln \psi - 1}$

Q.31 The cross-section of a built-up wooden beam as shown in the figure (*not drawn to scale*) is subjected to a vertical shear force of 8 kN. The beam is symmetrical about the neutral axis (N.A.) shown, and the moment of inertia about N.A. is $1.5 \times 10^9 \text{ mm}^4$. Considering that the nails at the location P are spaced longitudinally (along the length of the beam) at 60 mm, each of the nails at P will be subjected to the shear force of

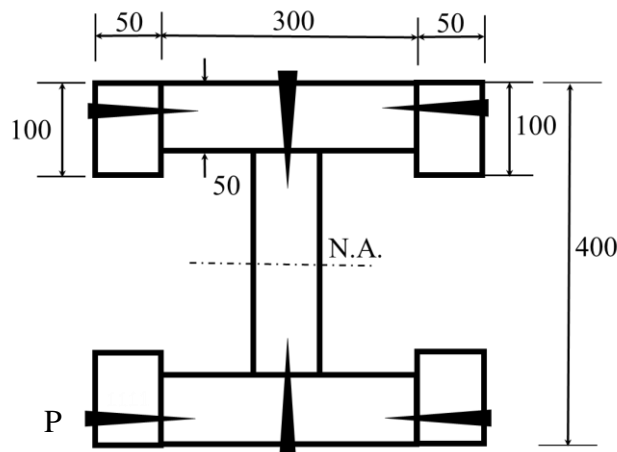

All dimensions are in mm

- (A) 60 N
- (B) 120 N
- (C) 240 N
- (D) 480 N

- Q.32 The rigid-jointed plane frame QRS shown in the figure is subjected to a load P at the joint R. Let the axial deformations in the frame be neglected. If the support S undergoes a settlement of $\Delta = \frac{PL^3}{\beta EI}$, the vertical reaction at the support S will become zero when β is equal to

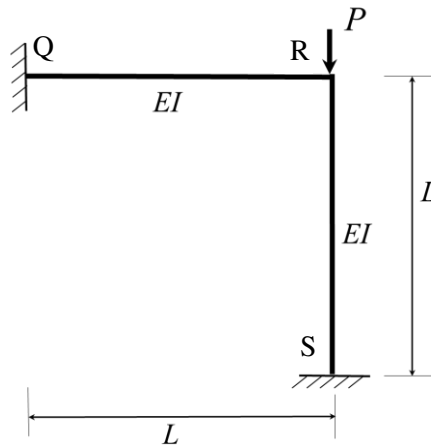

- (A) 0.1 (B) 3.0 (C) 7.5 (D) 48.0
- Q.33 If the section shown in the figure turns from fully-elastic to fully-plastic, the depth of neutral axis (N.A.), \bar{y} , decreases by

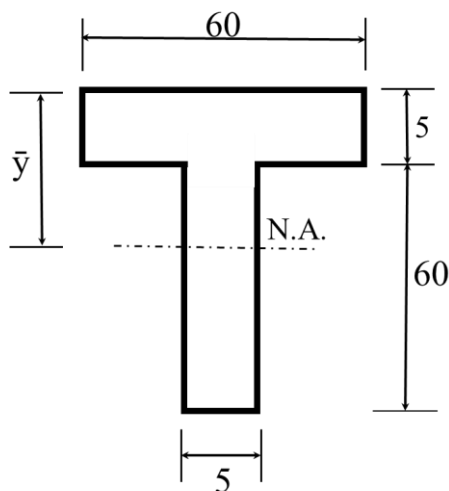

Figure not to scale
All dimensions are in mm

- (A) 10.75 mm (B) 12.25 mm (C) 13.75 mm (D) 15.25 mm

Q.34 Sedimentation basin in a water treatment plant is designed for a flow rate of $0.2 \text{ m}^3/\text{s}$. The basin is rectangular with a length of 32 m , width of 8 m , and depth of 4 m . Assume that the settling velocity of these particles is governed by the Stokes' law. Given: density of the particles = 2.5 g/cm^3 ; density of water = 1 g/cm^3 ; dynamic viscosity of water = 0.01 g/(cm.s) ; gravitational acceleration = 980 cm/s^2 . If the incoming water contains particles of diameter $25 \mu\text{m}$ (spherical and uniform), the removal efficiency of these particles is

- (A) 51% (B) 65% (C) 78% (D) 100%

Q.35 A survey line was measured to be 285.5 m with a tape having a nominal length of 30 m . On checking, the true length of the tape was found to be 0.05 m too short. If the line lay on a slope of 1 in 10, the reduced length (horizontal length) of the line for plotting of survey work would be

- (A) 283.6 m (B) 284.5 m (C) 285.0 m (D) 285.6 m

Q.36 A 16 mm thick gusset plate is connected to the 12 mm thick flange plate of an I-section using fillet welds on both sides as shown in the figure (not drawn to scale). The gusset plate is subjected to a point load of 350 kN acting at a distance of 100 mm from the flange plate. Size of fillet weld is 10 mm .

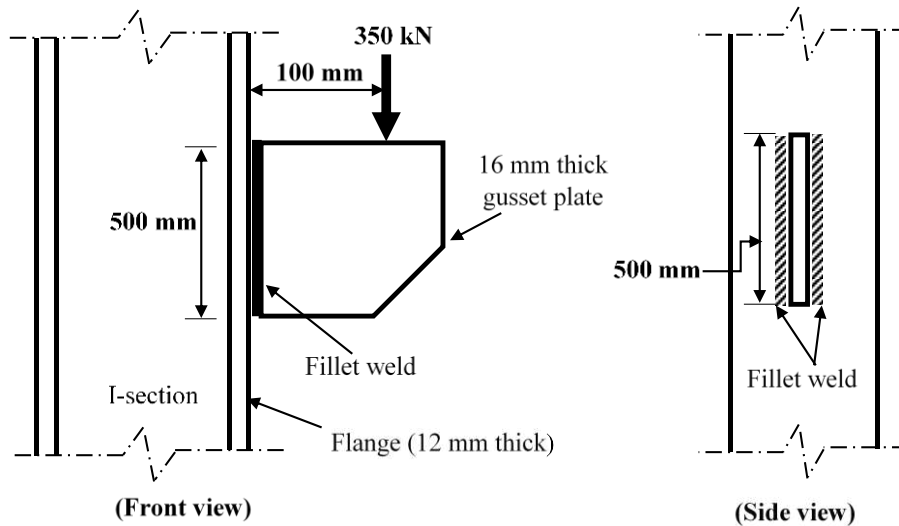

The maximum resultant stress (in MPa , round off to 1 decimal place) on the fillet weld along the vertical plane would be _____

- Q.37 The network of a small construction project awarded to a contractor is shown in the following figure. The normal duration, crash duration, normal cost, and crash cost of all the activities are shown in the table. The indirect cost incurred by the contractor is *INR* 5000 per day.

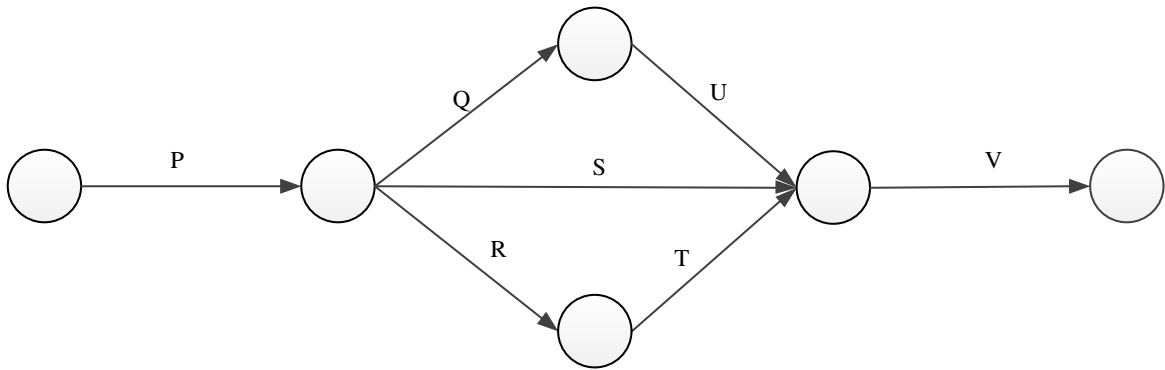

Activity	Normal Duration (days)	Crash Duration (days)	Normal Cost (INR)	Crash Cost (INR)
P	6	4	15000	25000
Q	5	2	6000	12000
R	5	3	8000	9500
S	6	3	7000	10000
T	3	2	6000	9000
U	2	1	4000	6000
V	4	2	20000	28000

If the project is targeted for completion in 16 days, the total cost (in *INR*) to be incurred by the contractor would be _____

- Q.38 A box measuring $50\text{ cm} \times 50\text{ cm} \times 50\text{ cm}$ is filled to the top with dry coarse aggregate of mass 187.5 kg . The water absorption and specific gravity of the aggregate are 0.5% and 2.5 , respectively. The maximum quantity of water (in *kg*, round off to 2 decimal places) required to fill the box completely is _____

- Q.39 A portal frame shown in figure (*not drawn to scale*) has a hinge support at joint P and a roller support at joint R. A point load of 50 kN is acting at joint R in the horizontal direction. The flexural rigidity, EI , of each member is 10^6 kNm^2 . Under the applied load, the horizontal displacement (in mm, round off to 1 decimal place) of joint R would be _____

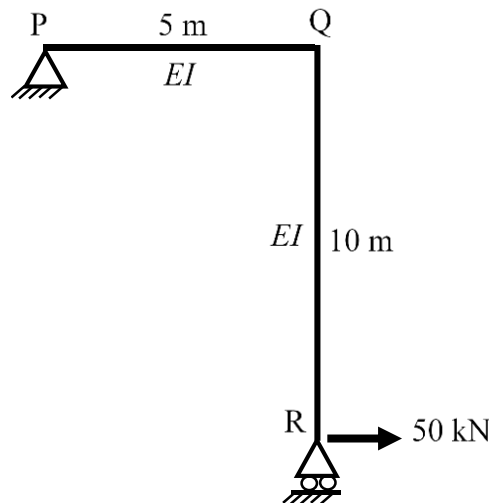

- Q.40 A sample of air analysed at 0°C and 1 atm pressure is reported to contain 0.02 ppm (parts per million) of NO_2 . Assume the gram molecular mass of NO_2 as 46 and its volume at 0°C and 1 atm pressure as 22.4 litres per mole. The equivalent NO_2 concentration (in microgram per cubic meter, round off to 2 decimal places) would be _____
- Q.41 A 0.80 m deep bed of sand filter (length 4 m and width 3 m) is made of uniform particles (diameter = 0.40 mm, specific gravity = 2.65, shape factor = 0.85) with bed porosity of 0.4. The bed has to be backwashed at a flow rate of $3.60 \text{ m}^3/\text{min}$. During backwashing, if the terminal settling velocity of sand particles is 0.05 m/s, the expanded bed depth (in m, round off to 2 decimal places) is _____
- Q.42 A wastewater is to be disinfected with 35 mg/L of chlorine to obtain 99% kill of micro-organisms. The number of micro-organisms remaining alive (N_t) at time t , is modelled by $N_t = N_o e^{-kt}$, where N_o is number of micro-organisms at $t = 0$, and k is the rate of kill. The wastewater flow rate is $36 \text{ m}^3/\text{h}$, and $k = 0.23 \text{ min}^{-1}$. If the depth and width of the chlorination tank are 1.5 m and 1.0 m, respectively, the length of the tank (in m, round off to 2 decimal places) is _____

- Q.43 A staff is placed on a benchmark (BM) of reduced level (RL) 100.000 m and a theodolite is placed at a horizontal distance of 50 m from the BM to measure the vertical angles. The measured vertical angles from the horizontal at the staff readings of 0.400 m and 2.400 m are found to be the same. Taking the height of the instrument as 1.400 m , the RL (in m) of the theodolite station is _____
- Q.44 Consider the ordinary differential equation $x^2 \frac{d^2y}{dx^2} - 2x \frac{dy}{dx} + 2y = 0$. Given the values of $y(1) = 0$ and $y(2) = 2$, the value of $y(3)$ (round off to 1 decimal place), is _____
- Q.45 Average free flow speed and the jam density observed on a road stretch are 60 km/h and 120 vehicles/km , respectively. For a linear speed-density relationship, the maximum flow on the road stretch (in vehicles/h) is _____
- Q.46 Traffic on a highway is moving at a rate of $360\text{ vehicles per hour}$ at a location. If the number of vehicles arriving on this highway follows Poisson distribution, the probability (round off to 2 decimal places) that the headway between successive vehicles lies between 6 and 10 seconds is _____
- Q.47 A parabolic vertical curve is being designed to join a road of grade $+5\%$ with a road of grade -3% . The length of the vertical curve is 400 m measured along the horizontal. The vertical point of curvature (VPC) is located on the road of grade $+5\%$. The difference in height between VPC and vertical point of intersection (VPI) (in m , round off to the nearest integer) is _____
- Q.48 Tie bars of 12 mm diameter are to be provided in a concrete pavement slab. The working tensile stress of the tie bars is 230 MPa , the average bond strength between a tie bar and concrete is 2 MPa , and the joint gap between the slabs is 10 mm . Ignoring the loss of bond and the tolerance factor, the design length of the tie bars (in mm , round off to the nearest integer) is _____

Q.49 The hietograph of a storm event of duration 140 *minutes* is shown in the figure.

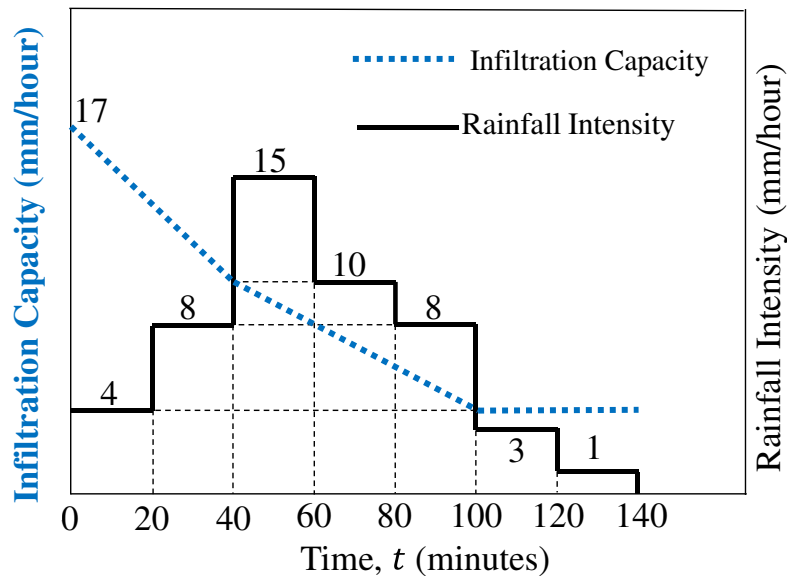

The infiltration capacity at the start of this event ($t = 0$) is 17 *mm/hour*, which linearly decreases to 10 *mm/hour* after 40 *minutes* duration. As the event progresses, the infiltration rate further drops down linearly to attain a value of 4 *mm/hour* at $t = 100$ *minutes* and remains constant thereafter till the end of the storm event. The value of the infiltration index, ϕ (in *mm/hour*, round off to 2 decimal places), is _____

Q.50 Two water reservoirs are connected by a siphon (running full) of total length 5000 *m* and diameter of 0.10 *m*, as shown below (*figure not drawn to scale*).

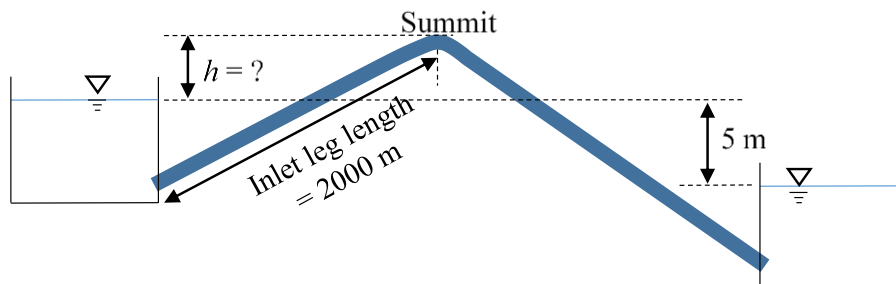

The inlet leg length of the siphon to its summit is 2000 *m*. The difference in the water surface levels of the two reservoirs is 5 *m*. Assume the permissible minimum absolute pressure at the summit of siphon to be 2.5 *m* of water when running full. Given: friction factor $f = 0.02$ throughout, atmospheric pressure = 10.3 *m* of water, and acceleration due to gravity $g = 9.81$ *m/s*². Considering only major loss using Darcy-Weisbach equation, the maximum height of the summit of siphon from the water level of upper reservoir, h (in *m*, round off to 1 decimal place) is _____

- Q.51 Consider a laminar flow in the x -direction between two infinite parallel plates (Couette flow). The lower plate is stationary and the upper plate is moving with a velocity of 1 cm/s in the x -direction. The distance between the plates is 5 mm and the dynamic viscosity of the fluid is $0.01 \text{ N}\cdot\text{s}/\text{m}^2$. If the shear stress on the lower plate is zero, the pressure gradient, $\frac{\partial p}{\partial x}$, (in N/m^2 per m , round off to 1 decimal place) is _____
- Q.52 A reinforced concrete circular pile of 12 m length and 0.6 m diameter is embedded in stiff clay which has an undrained unit cohesion of $110 \text{ kN}/\text{m}^2$. The adhesion factor is 0.5 . The Net Ultimate Pullout (uplift) Load for the pile (in kN , round off to 1 decimal place) is _____
- Q.53 A granular soil has a saturated unit weight of $20 \text{ kN}/\text{m}^3$ and an effective angle of shearing resistance of 30° . The unit weight of water is $9.81 \text{ kN}/\text{m}^3$. A slope is to be made on this soil deposit in which the seepage occurs parallel to the slope up to the free surface. Under this seepage condition for a factor of safety of 1.5 , the safe slope angle (in degree, round off to 1 decimal place) would be _____
- Q.54 A $3 \text{ m} \times 3 \text{ m}$ square precast reinforced concrete segments to be installed by pushing them through an existing railway embankment for making an underpass as shown in the figure. A reaction arrangement using precast PCC blocks placed on the ground is to be made for the jacks.

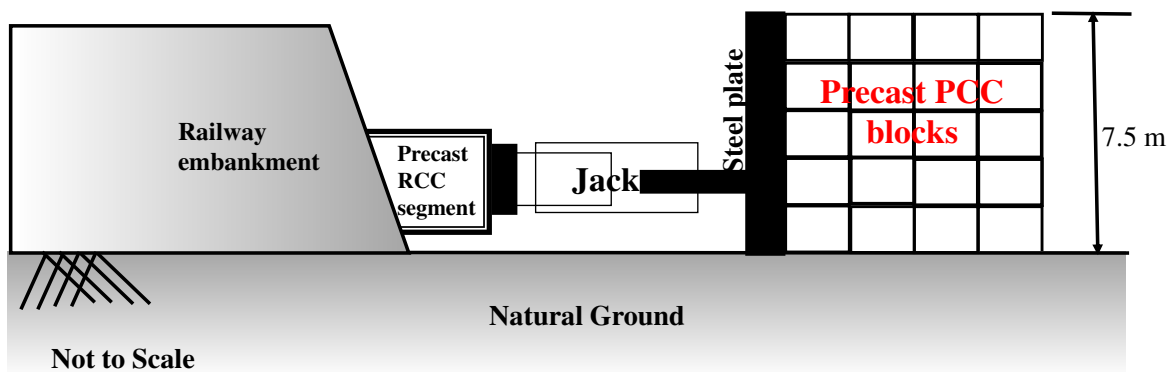

At each stage, the jacks are required to apply a force of 1875 kN to push the segment. The jacks will react against the rigid steel plate placed against the reaction arrangement. The footprint area of reaction arrangement on natural ground is 37.5 m^2 . The unit weight of PCC block is $24 \text{ kN}/\text{m}^3$. The properties of the natural ground are: $c = 17 \text{ kPa}$; $\phi = 25^\circ$ and $\gamma = 18 \text{ kN}/\text{m}^3$. Assuming that the reaction arrangement has rough interface and has the same properties that of soil, the factor of safety (round off to 1 decimal place) against shear failure is _____

- Q.55 A square footing of 4 m side is placed at 1 m depth in a sand deposit. The dry unit weight (γ) of sand is 15 kN/m^3 . This footing has an ultimate bearing capacity of 600 kPa . Consider the depth factors: $d_q = d_\gamma = 1.0$ and the bearing capacity factor: $N_\gamma = 18.75$. This footing is placed at a depth of 2 m in the same soil deposit. For a factor of safety of 3.0 as per Terzaghi's theory, the safe bearing capacity (in kPa) of this footing would be _____

END OF THE QUESTION PAPER

Q. 1 – Q. 5 carry one mark each.

Q.1 Daytime temperatures in Delhi can _____ 40°C.

- (A) get (B) stand (C) reach (D) peak

Q.2 The growth rate of ABC Motors in 2017 was the same _____ XYZ Motors in 2016.

- (A) as off (B) as those of (C) as that off (D) as that of

Q.3 Suresh wanted to lay a new carpet in his new mansion with an area of 70×55 sq. mts. However an area of 550 sq. mts. had to be left out for flower pots. If the cost of carpet is Rs. 50 per sq. mts., how much money (in Rs.) will be spent by Suresh for the carpet now?

- (A) Rs. 1,65,000 (B) Rs. 1,92,500 (C) Rs. 2,75,000 (D) Rs. 1,27,500

Q.4 A retaining wall with measurements $30\text{m} \times 12\text{m} \times 6\text{m}$ was constructed with bricks of dimensions $8\text{cm} \times 6\text{cm} \times 6\text{cm}$. If 60% of the wall consists of bricks, the number of bricks used for the construction is _____ lakhs.

- (A) 30 (B) 40 (C) 45 (D) 75

Q.5 Hima Das was _____ only Indian athlete to win _____ gold for India.

- (A) the, many (B) the, a (C) an, a (D) an, the

Q. 6 – Q. 10 carry two marks each.

Q.6 Mohan, the manager, wants his four workers to work in pairs. No pair should work for more than 5 hours. Ram and John have worked together for 5 hours. Krishna and Amir have worked as a team for 2 hours. Krishna does not want to work with Ram. Whom should Mohan allot to work with John, if he wants all the workers to continue working?

- (A) Amir (B) Krishna (C) Ram (D) None of the three

GATE 2019 General Aptitude (GA) Set-9

Q.7 Population of state X increased by $x\%$ and the population of state Y increased by $y\%$ from 2001 to 2011. Assume that x is greater than y . Let P be the ratio of the population of state X to state Y in a given year. The percentage increase in P from 2001 to 2011 is _____.

- (A) $\frac{x}{y}$ (B) $x - y$ (C) $\frac{100(x-y)}{100+x}$ (D) $\frac{100(x-y)}{100+y}$

Q.8 *The Newspaper* reports that over 500 hectares of tribal land spread across 28 tribal settlements in Mohinitampuram forest division have already been “alienated”. A top forest official said, “First the tribals are duped out of their land holdings. Second, the families thus rendered landless are often forced to encroach further into the forests”.

On the basis of the information available in the paragraph, _____ is/are responsible for duping the tribals.

- (A) forest officials
(B) landless families
(C) *The Newspaper*
(D) it cannot be inferred who

Q.9 An oil tank can be filled by pipe X in 5 hours and pipe Y in 4 hours, each pump working on its own. When the oil tank is full and the drainage hole is open, the oil is drained in 20 hours. If initially the tank was empty and someone started the two pumps together but left the drainage hole open, how many hours will it take for the tank to be filled? (Assume that the rate of drainage is independent of the Head)

- (A) 1.50 (B) 2.00 (C) 2.50 (D) 4.00

Q.10 “Popular Hindi fiction, despite – or perhaps because of – its wide reach, often does not appear in our cinema. As ideals that viewers are meant to look up to rather than identify with, Hindi film protagonists usually read books of aspirational value: textbooks, English books, or high value literature.”

Which one of the following CANNOT be inferred from the paragraph above?

- (A) Though popular Hindi fiction has wide reach, it often does not appear in the movies
(B) Protagonists in Hindi movies, being ideals for viewers, read only books of aspirational value
(C) Textbooks, English books or high literature have aspirational value, but not popular Hindi fiction
(D) People do not look up to writers of textbooks, English books or high value literature

END OF THE QUESTION PAPER

Q. 1 – Q. 25 carry one mark each.

Q.1 Euclidean norm (length) of the vector $[4 \quad -2 \quad -6]^T$ is

- (A) $\sqrt{12}$ (B) $\sqrt{24}$ (C) $\sqrt{48}$ (D) $\sqrt{56}$

Q.2 The Laplace transform of $\sinh(at)$ is

- (A) $\frac{a}{s^2 - a^2}$ (B) $\frac{a}{s^2 + a^2}$ (C) $\frac{s}{s^2 - a^2}$ (D) $\frac{s}{s^2 + a^2}$

Q.3 The following inequality is true for all x close to 0.

$$2 - \frac{x^2}{3} < \frac{x \sin x}{1 - \cos x} < 2$$

What is the value of $\lim_{x \rightarrow 0} \frac{x \sin x}{1 - \cos x}$?

- (A) 0 (B) 1/2 (C) 1 (D) 2

Q.4 What is curl of the vector field $2x^2y\mathbf{i} + 5z^2\mathbf{j} - 4yz\mathbf{k}$?

- (A) $6z\mathbf{i} + 4x\mathbf{j} - 2x^2\mathbf{k}$
(B) $6z\mathbf{i} - 8xy\mathbf{j} + 2x^2y\mathbf{k}$
(C) $-14z\mathbf{i} + 6y\mathbf{j} + 2x^2\mathbf{k}$
(D) $-14z\mathbf{i} - 2x^2\mathbf{k}$

Q.5 A closed thin-walled tube has thickness, t , mean enclosed area within the boundary of the centerline of tube's thickness, A_m , and shear stress, τ . Torsional moment of resistance, T , of the section would be

- (A) $0.5\tau A_m t$ (B) $\tau A_m t$ (C) $2\tau A_m t$ (D) $4\tau A_m t$

- Q.6 A steel column is restrained against both translation and rotation at one end and is restrained only against rotation but free to translate at the other end. Theoretical and design (IS:800- 2007) values, respectively, of effective length factor of the column are
- (A) 1.0 and 1.0 (B) 1.2 and 1.0 (C) 1.2 and 1.2 (D) 1.0 and 1.2
- Q.7 If the fineness modulus of a sample of fine aggregates is 4.3, the mean size of the particles in the sample is between
- (A) $150 \mu m$ and $300 \mu m$ (B) $300 \mu m$ and $600 \mu m$
 (C) $1.18 mm$ and $2.36 mm$ (D) $2.36 mm$ and $4.75 mm$
- Q.8 For a channel section subjected to a downward vertical shear force at its centroid, which one of the following represents the correct distribution of shear stress in flange and web?

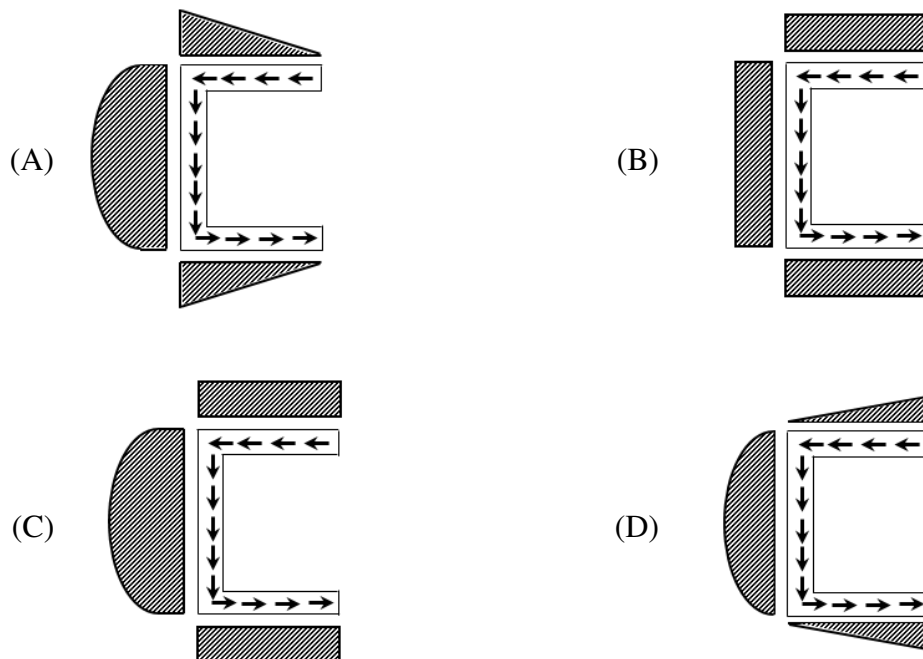

- Q.9 Which one of the following options contains ONLY primary air pollutants?
- (A) Hydrocarbons and nitrogen oxides
 (B) Hydrocarbons and ozone
 (C) Ozone and peroxyacetyl nitrate
 (D) Nitrogen oxides and peroxyacetyl nitrate

- Q.10 Analysis of a water sample revealed that the sample contains the following species.
 CO_3^{2-} , Na^+ , H^+ , PO_4^{3-} , Al^{3+} , H_2CO_3 , Cl^- , Ca^{2+} , Mg^{2+} , HCO_3^- , Fe^{2+} , OH^-
 Concentrations of which of the species will be required to compute alkalinity?
- (A) CO_3^{2-} , H^+ , HCO_3^- , OH^-
 (B) CO_3^{2-} , H^+ , H_2CO_3 , HCO_3^-
 (C) CO_3^{2-} , H_2CO_3 , HCO_3^- , OH^-
 (D) H^+ , H_2CO_3 , HCO_3^- , OH^-
- Q.11 Structural failures considered in the mechanistic method of bituminous pavement design are
- (A) Fatigue and Rutting (B) Fatigue and Shear
 (C) Rutting and Shear (D) Shear and Slippage
- Q.12 A solid sphere of radius, r , and made of material with density, ρ_s , is moving through the atmosphere (constant pressure, p) with a velocity, v . The net force ONLY due to atmospheric pressure (F_p) acting on the sphere at any time, t , is
- (A) $\pi r^2 p$ (B) $4\pi r^2 p$ (C) $\frac{4}{3}\pi r^3 \rho_s \frac{dv}{dt}$ (D) zero
- Q.13 The velocity field in a flow system is given by $v = 2\mathbf{i} + (x + y)\mathbf{j} + (xyz)\mathbf{k}$. The acceleration of the fluid at $(1, 1, 2)$ is
- (A) $2\mathbf{i} + 10\mathbf{k}$ (B) $4\mathbf{i} + 12\mathbf{k}$
 (C) $\mathbf{j} + \mathbf{k}$ (D) $4\mathbf{j} + 10\mathbf{k}$
- Q.14 An inflow hydrograph is routed through a reservoir to produce an outflow hydrograph. The peak flow of the inflow hydrograph is P_I and the time of occurrence of the peak is t_I . The peak flow of the outflow hydrograph is P_O and the time of occurrence of the peak is t_O . Which one of the following statements is correct?
- (A) $P_I < P_O$ and $t_I < t_O$
 (B) $P_I < P_O$ and $t_I > t_O$
 (C) $P_I > P_O$ and $t_I < t_O$
 (D) $P_I > P_O$ and $t_I > t_O$

Q.15 An earthen dam of height H is made of cohesive soil whose cohesion and unit weight are c and γ , respectively. If the factor of safety against cohesion is F_c , the Taylor's stability number (S_n) is

- (A) $\frac{\gamma H}{c F_c}$ (B) $\frac{c F_c}{\gamma H}$ (C) $\frac{c}{F_c \gamma H}$ (D) $\frac{F_c \gamma H}{c}$

Q.16 The notation "SC" as per *Indian Standard Soil Classification System* refers to

- (A) Sandy clay
 (B) Silty clay
 (C) Clayey silt
 (D) Clayey sand

Q.17 An anisotropic soil deposit has coefficient of permeability in vertical and horizontal directions as k_z and k_x , respectively. For constructing a flow net, the horizontal dimension of the problem's geometry is transformed by a multiplying factor of

- (A) $\sqrt{\frac{k_z}{k_x}}$ (B) $\sqrt{\frac{k_x}{k_z}}$ (C) $\frac{k_x}{k_z}$ (D) $\frac{k_z}{k_x}$

Q.18 The value of the function $f(x)$ is given at n distinct values of x and its value is to be interpolated at the point x^* , using all the n points. The estimate is obtained first by the Lagrange polynomial, denoted by I_L , and then by the Newton polynomial, denoted by I_N . Which one of the following statements is correct?

- (A) I_L is always greater than I_N
 (B) I_L and I_N are always equal
 (C) I_L is always less than I_N
 (D) No definite relation exists between I_L and I_N

Q.19 The speed-density relationship in a mid-block section of a highway follows the Greenshield's model. If the free flow speed is v_f and the jam density is k_j , the maximum flow observed on this section is

- (A) $v_f k_j$ (B) $\frac{v_f k_j}{2}$ (C) $\frac{v_f k_j}{4}$ (D) $\frac{v_f k_j}{8}$

Q.20 The degree of static indeterminacy of the plane frame as shown in the figure is _____

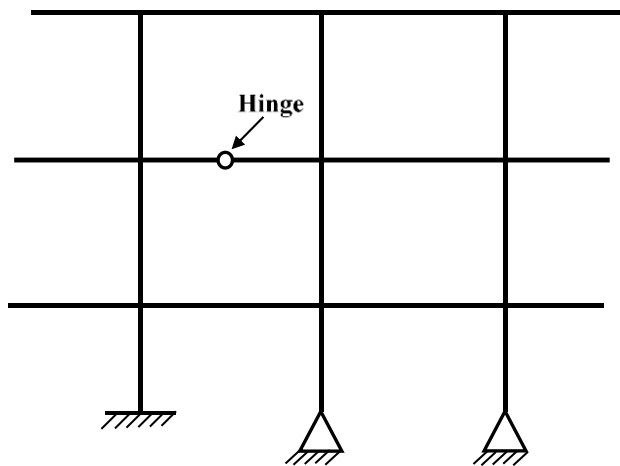

Q.21 The characteristic compressive strength of concrete required in a project is 25 MPa and the standard deviation in the observed compressive strength expected at site is 4 MPa . The average compressive strength of cubes tested at different water-cement (w/c) ratios using the same material as is used for the project is given in the table.

w/c (%)	45	50	55	60
Average compressive strength of cubes (MPa)	35	25	20	15

The water-cement ratio (in percent, round off to the **lower integer**) to be used in the mix is _____

Q.22 The data from a closed traverse survey PQRS (run in the clockwise direction) are given in the table

Line	Included angle (in degrees)
PQ	88
QR	92
RS	94
SP	89

The closing error for the traverse PQRS (in degrees) is _____

- Q.23 A vehicle is moving on a road of grade +4% at a speed of 20 m/s . Consider the coefficient of rolling friction as 0.46 and acceleration due to gravity as 10 m/s^2 . On applying brakes to reach a speed of 10 m/s , the required braking distance (in m , round off to nearest integer) along the horizontal, is _____
- Q.24 The command area of a canal grows only one crop, i.e., wheat. The base period of wheat is 120 days and its total water requirement, Δ , is 40 cm . If the canal discharge is 2 m^3/s , the area, in *hectares*, rounded off to the nearest integer, which could be irrigated (*neglecting all losses*) is _____
- Q.25 Construction of a new building founded on a clayey soil was completed in January 2010. In January 2014, the average consolidation settlement of the foundation in clay was recorded as 10 mm . The ultimate consolidation settlement was estimated in design as 40 mm . Considering double drainage to occur at the clayey soil site, the expected consolidation settlement in January 2019 (in mm , round off to the nearest integer) will be _____

Q. 26 – Q. 55 carry two marks each.

Q.26 The probability density function of a continuous random variable distributed uniformly between x and y (for $y > x$) is

- (A) $\frac{1}{x-y}$ (B) $\frac{1}{y-x}$ (C) $x-y$ (D) $y-x$

Q.27 Consider the hemi-spherical tank of radius 13 m as shown in the figure (*not drawn to scale*). What is the volume of water (in m^3) when the depth of water at the centre of the tank is 6 m ?

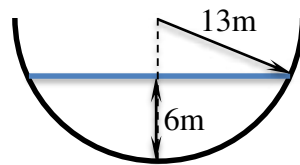

- (A) 78π (B) 156π (C) 396π (D) 468π

Q.28 An ordinary differential equation is given below.

$$\left(\frac{dy}{dx}\right)(x \ln x) = y$$

The solution for the above equation is

(Note: K denotes a constant in the options)

- (A) $y = Kx \ln x$ (B) $y = Kxe^x$
 (C) $y = Kxe^{-x}$ (D) $y = K \ln x$

- Q.31 In the context of provisions relating to durability of concrete, consider the following assertions:
- Assertion (1):** As per IS 456-2000, air entrainment to the extent of 3% to 6% is required for concrete exposed to marine environment.
- Assertion (2):** The equivalent alkali content (in terms of Na₂O equivalent) for a cement containing 1% and 0.6% of Na₂O and K₂O, respectively, is approximately 1.4% (rounded to 1 decimal place).
- Which one of the following statements is CORRECT?
- (A) Assertion (1) is FALSE and Assertion (2) is TRUE
(B) Assertion (1) is TRUE and Assertion (2) is FALSE
(C) Both Assertion (1) and Assertion (2) are FALSE
(D) Both Assertion (1) and Assertion (2) are TRUE
- Q.32 Chlorine is used as the disinfectant in a municipal water treatment plant. It achieves 50 percent of disinfection efficiency measured in terms of killing the indicator microorganisms (*E-Coli*) in 3 minutes. The minimum time required to achieve 99 percent disinfection efficiency would be
- (A) 9.93 minutes
(B) 11.93 minutes
(C) 19.93 minutes
(D) 21.93 minutes
- Q.33 A camera with a focal length of 20 cm fitted in an aircraft is used for taking vertical aerial photographs of a terrain. The average elevation of the terrain is 1200 m above mean sea level (MSL). What is the height above MSL at which an aircraft must fly in order to get the aerial photographs at a scale of 1:8000?
- (A) 2600 m
(B) 2800 m
(C) 3000 m
(D) 3200 m
- Q.34 A flexible pavement has the following class of loads during a particular hour of the day.
- 80 buses with 2-axles (each axle load of 40 kN);
 - 160 trucks with 2-axles (front and rear axle loads of 40 kN and 80 kN, respectively)
- The equivalent standard axle load repetitions for this vehicle combination as per IRC:37-2012 would be
- (A) 180 (B) 240 (C) 250 (D) 320

Q.35

The inverse of the matrix $\begin{bmatrix} 2 & 3 & 4 \\ 4 & 3 & 1 \\ 1 & 2 & 4 \end{bmatrix}$ is

(A) $\begin{bmatrix} 10 & -4 & -9 \\ -15 & 4 & 14 \\ 5 & -1 & -6 \end{bmatrix}$

(B) $\begin{bmatrix} -10 & 4 & 9 \\ 15 & -4 & -14 \\ -5 & 1 & 6 \end{bmatrix}$

(C) $\begin{bmatrix} -2 & \frac{4}{5} & \frac{9}{5} \\ 3 & -\frac{4}{5} & -\frac{14}{5} \\ -1 & \frac{1}{5} & \frac{6}{5} \end{bmatrix}$

(D) $\begin{bmatrix} 2 & -\frac{4}{5} & -\frac{9}{5} \\ -3 & \frac{4}{5} & \frac{14}{5} \\ 1 & -\frac{1}{5} & -\frac{6}{5} \end{bmatrix}$

Q.36 A long uniformly distributed load of 10 kN/m and a concentrated load of 60 kN are moving together on the beam ABCD shown in the figure (*not drawn to scale*). The relative positions of the two loads are not fixed. The maximum shear force (in kN , round off to the nearest integer) caused at the internal hinge B due to the two loads is _____

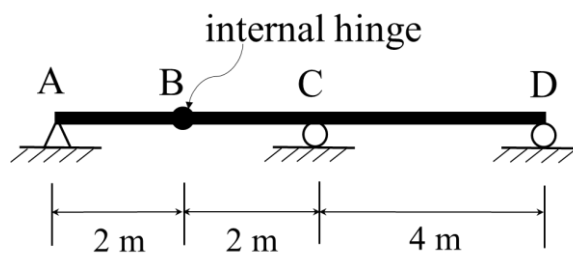

Q.37 A plane frame shown in the figure (*not to scale*) has linear elastic springs at node H. The spring constants are $k_x = k_y = 5 \times 10^5 \text{ kN/m}$ and $k_\theta = 3 \times 10^5 \text{ kNm/rad}$.

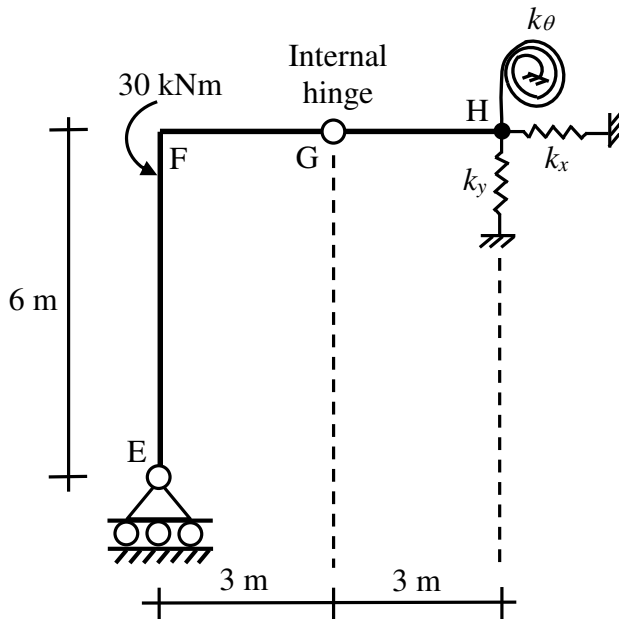

For the externally applied moment of 30 kNm at node F, the rotation (in **degrees**, round off to 3 decimals) observed in the rotational spring at node H is _____

Q.38 A rolled *I*-section beam is supported on a 75 mm wide bearing plate as shown in the figure. Thicknesses of flange and web of the *I*-section are 20 mm and 8 mm, respectively. Root radius of the *I*-section is 10 mm. Assume: material yield stress, $f_y = 250 \text{ MPa}$ and partial safety factor for material, $\gamma_{m0} = 1.10$.

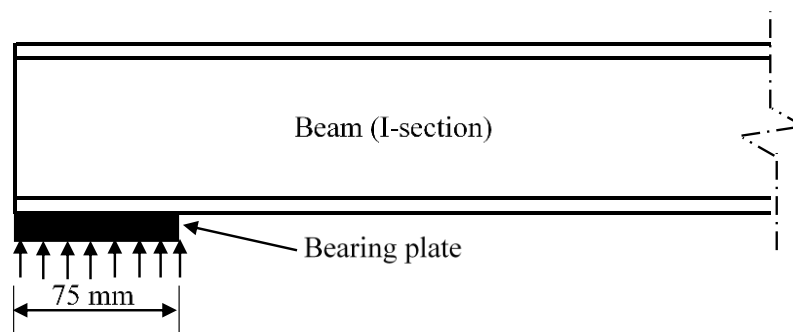

As per IS: 800-2007, the web bearing strength (in kN, round off to 2 decimal places) of the beam is _____

Q.39 When a specimen of M25 concrete is loaded to a stress level of 12.5 MPa , a strain of 500×10^{-6} is recorded. If this load is allowed to stand for a long time, the strain increases to 1000×10^{-6} . In accordance with the provisions of IS:456-2000, considering the long-term effects, the effective modulus of elasticity of the concrete (in MPa) is _____

Q.40 A water treatment plant treats 6000 m^3 of water per day. As a part of the treatment process, discrete particles are required to be settled in a clarifier. A column test indicates that an overflow rate of 1.5 m per hour would produce the desired removal of particles through settling in the clarifier having a depth of 3.0 m . The volume of the required clarifier, (in m^3 , round off to 1 decimal place) would be _____

Q.41 Raw municipal solid waste (MSW) collected from a city contains 70% decomposable material that can be converted to methane. The water content of the decomposable material is 35%. An elemental analysis of the decomposable material yields the following mass percent.

$$\text{C} : \text{H} : \text{O} : \text{N} : \text{other} = 44 : 6 : 43 : 0.8 : 6.2$$

The methane production of the decomposable material is governed by the following stoichiometric relation

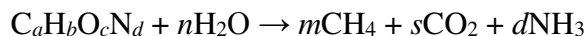

Given atomic weights: C = 12, H = 1, O = 16, N = 14. The mass of methane produced (in grams, round off to 1 decimal place) per kg of raw MSW will be _____

Q.42 Consider the reactor shown in the figure. The flow rate through the reactor is $Q \text{ m}^3/\text{h}$. The concentrations (in mg/L) of a compound in the influent and effluent are C_0 and C , respectively. The compound is degraded in the reactor following the first order reaction. The mixing condition of the reactor can be varied such that the reactor becomes either a completely mixed flow reactor (CMFR) or a plug-flow reactor (PFR). The length of the reactor can be adjusted in these two mixing conditions to L_{CMFR} and L_{PFR} while keeping the cross-section of the reactor constant. Assuming steady state and for $C/C_0 = 0.8$, the value of $L_{\text{CMFR}}/L_{\text{PFR}}$ (round off to 2 decimal places) is _____

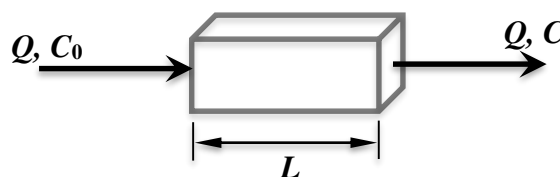

- Q.43 A series of perpendicular offsets taken from a curved boundary wall to a straight survey line at an interval of 6 m are 1.22, 1.67, 2.04, 2.34, 2.14, 1.87, and 1.15 m. The area (in m^2 , round off to 2 decimal places) bounded by the survey line, curved boundary wall, the first and the last offsets, determined using Simpson's rule, is _____
- Q.44 The uniform arrival and uniform service rates observed on an approach road to a signalized intersection are 20 and 50 vehicles/minute, respectively. For this signal, the red time is 30 s, the effective green time is 30 s, and the cycle length is 60 s. Assuming that initially there are no vehicles in the queue, the average delay per vehicle using the approach road during a cycle length (in s, round off to 2 decimal places) is _____
- Q.45 A broad gauge railway line passes through a horizontal curved section (radius = 875 m) of length 200 m. The allowable speed on this portion is 100 km/h. For calculating the cant, consider the gauge as centre-to-centre distance between the rail heads, equal to 1750 mm. The maximum permissible cant (in mm, round off to 1 decimal place) with respect to the centre-to-centre distance between the rail heads is _____
- Q.46 The speed-density relationship of a highway is given as

$$u = 100 - 0.5 k$$

where, u = speed in km per hour, k = density in vehicles per km. The maximum flow (in vehicles per hour, round off to the nearest integer) is _____

- Q.47 A confined aquifer of 15 m constant thickness is sandwiched between two aquicludes as shown in the figure (not drawn to scale).

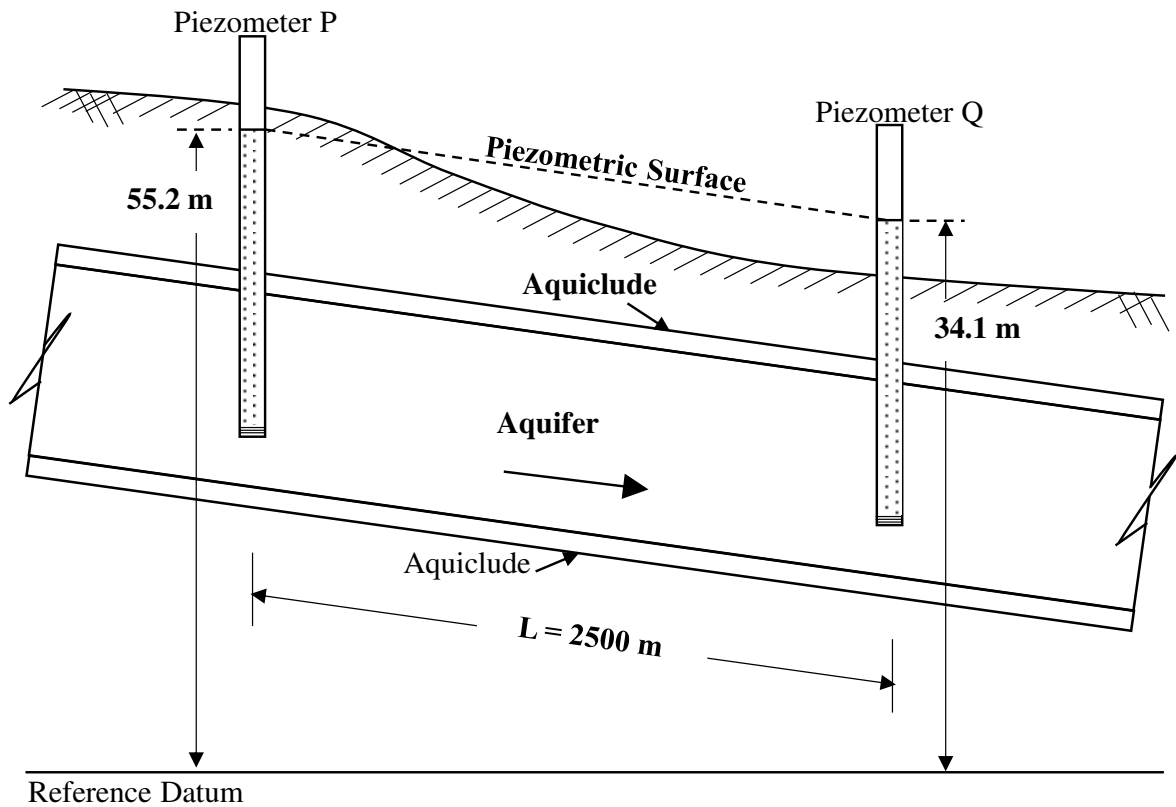

The heads indicated by two piezometers P and Q are 55.2 m and 34.1 m, respectively. The aquifer has a hydraulic conductivity of 80 m/day and its effective porosity is 0.25. If the distance between the piezometers is 2500 m, the time taken by the water to travel through the aquifer from piezometer location P to Q (in days, round off to 1 decimal place) is _____

- Q.48 At the foot of a spillway, water flows at a depth of 23 cm with a velocity of 8.1 m/s, as shown in the figure.

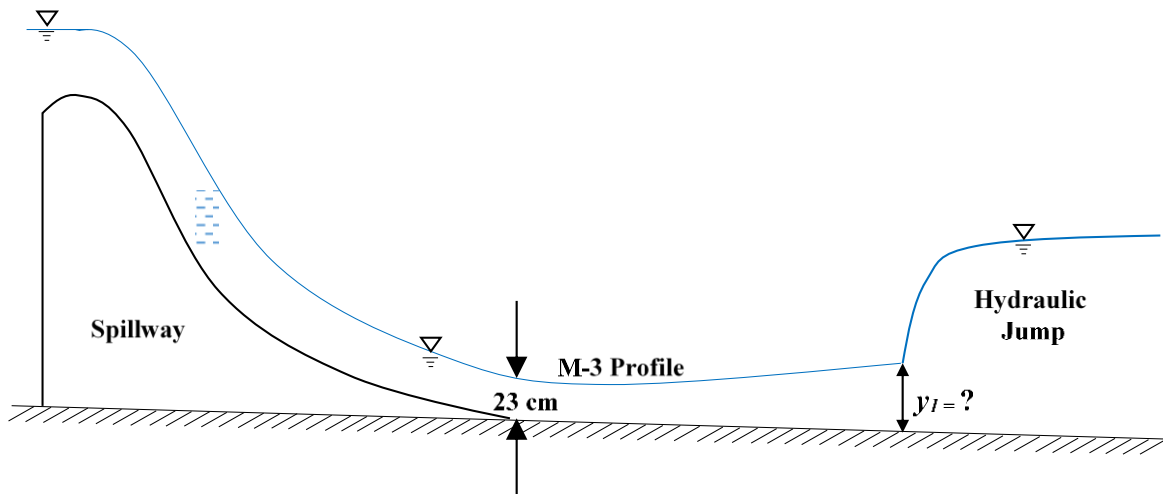

The flow enters as an M-3 profile in the long wide rectangular channel with bed slope = $\frac{1}{1800}$ and Manning's $n = 0.015$. A hydraulic jump is formed at a certain distance from the foot of the spillway. Assume the acceleration due to gravity, $g = 9.81 \text{ m/s}^2$. Just before the hydraulic jump, the depth of flow y_1 (in m, round off to 2 decimal places) is _____

- Q.49 Two identical pipes (i.e., having the same length, same diameter, and same roughness) are used to withdraw water from a reservoir. In the first case, they are attached in series and discharge freely into the atmosphere. In the second case, they are attached in parallel and also discharge freely into the atmosphere. Neglecting all minor losses, and assuming that the friction factor is same in both the cases, the ratio of the discharge in the parallel arrangement to that in the series arrangement (round off to 2 decimal places) is _____

- Q.50 The ordinates, u , of a 2-hour unit hydrograph (i.e., for 1 cm of effective rain), for a catchment are shown in the table.

t (hour)	0	1	2	3	4	5	6	7	8	9	10	11	12
u (m^3/s)	0	2	8	18	32	45	30	19	12	7	3	1	0

A 6-hour storm occurs over the catchment such that the effective rainfall intensity is 1 cm/hour for the first two hours, zero for the next two hours, and 0.5 cm/hour for the last two hours. If the base flow is constant at 5 m^3/s , the peak flow due to this storm (in m^3/s , round off to 1 decimal place) will be _____

Q.51 The dimensions of a soil sampler are given in the table.

Parameter	Cutting edge	Sampling tube
Inside diameter (<i>mm</i>)	80	86
Outside diameter (<i>mm</i>)	100	90

For this sampler, the outside clearance ratio (in percent, round off to 2 decimal places) is _____

Q.52 A $2\text{ m} \times 4\text{ m}$ rectangular footing has to carry a uniformly distributed load of 120 kPa . As per the 2:1 dispersion method of stress distribution, the increment in vertical stress (in kPa) at a depth of 2 m below the footing is _____

Q.53 Constant head permeability tests were performed on two soil specimens, S_1 and S_2 . The ratio of height of the two specimens ($L_{S_1}:L_{S_2}$) is 1.5, the ratio of the diameter of specimens ($D_{S_1}:D_{S_2}$) is 0.5, and the ratio of the constant head ($h_{S_1}:h_{S_2}$) applied on the specimens is 2.0. If the discharge from both the specimens is equal, the ratio of the permeability of the soil specimens ($k_{S_1}:k_{S_2}$) is _____

Q.54 A timber pile of length 8 m and diameter 0.2 m is driven with a 20 kN drop hammer, falling freely from a height of 1.5 m . The total penetration of the pile in the last 5 blows is 40 mm . Use the Engineering News Record expression. Assume a factor of safety of 6 and empirical factor (allowing reduction in the theoretical set, due to energy losses) of 2.5 cm . The safe load carrying capacity of the pile (in kN , round off to 2 decimal places) is _____

Q.55 A square footing of 2 m sides rests on the surface of a homogeneous soil bed having the properties: cohesion $c = 24\text{ kPa}$, angle of internal friction $\phi = 25^\circ$, and unit weight $\gamma = 18\text{ kN/m}^3$. Terzaghi's bearing capacity factors for $\phi = 25^\circ$ are $N_c = 25.1$, $N_q = 12.7$, $N_\gamma = 9.7$, $N_c' = 14.8$, $N_q' = 5.6$, and $N_\gamma' = 3.2$. The ultimate bearing capacity of the foundation (in kPa , round off to 2 decimal places) is _____

END OF THE QUESTION PAPER