

Eklavya Eklavya 2021

ONE BOW GURU MANTRA GOAL

Get a Chance to Learn from **India's Best Teachers** & Crack **JEE ADVANCED 2021**

Vedantu's Eklavya 2021 is a Specialized Program for JEE ADVANCED, designed and headed by Co-Founder, IIT alumnus and Master Teacher Anand Prakash. Get mentored by **Top JEE Experts**, who have produced JEE Advanced **AIR 1, 2, 4, 7**, & many more.

Anand Prakash

Co-Founder, Vedantu
IIT- Roorkee



Our Previous **EKLAVYANs** & Their Achievements

Student Name	Main Rank	Advanced Rank
Chirag Jain	731	41
Prakhar Agrawal	445	177
Tanmay Gangwar	2133	227
Aditya Kukreja	1772	635
Eknor Singh	3574	1243
Aditya Gupta	14275	1326

547 JEE Advanced Selections in 2020

JOIN NOW



Study Materials

- [JEE Main & Advanced – Free Study Material](#)
- [NEET UG – Free Study Material](#)
- [NCERT Solutions for Class 1 to 12](#)
- [NCERT Books PDF for Class 1 to 12](#)
- [ICSE & ISC Free Study Material](#)
- [Free Study Material for Kids Learning \(Grade 1 to 5\)](#)
- [Olympiad Free Study Material](#)
- [Reference Books \(RS Aggarwal, RD Sharma, HC Verma, Lakhmir Singh, Exemplar and More\)](#)
- [Previous Year Question Paper CBSE & State Boards](#)
- [Sample Papers](#)
- [Access All Free Study Material Here](#)

JEE-Main-27-07-2021-Shift-1 (Memory Based)

PHYSICS

Question: Energy of an oscillating system is E . At a particular instant kinetic energy of system is $3E/4$. Find

displacement of the oscillating particle from its mean position. Its amplitude of oscillation is A .

Options:

(A) $\frac{A}{2}$

(B) $\frac{A}{3}$

(C) $\frac{A}{4}$

(D) $\frac{A}{6}$

Answer: (A)

Solution:

$$\frac{1}{2}m\omega^2(A^2 - x^2) = \frac{3}{4}\left(\frac{1}{2}m\omega^2 A^2\right)$$

$$\Rightarrow A^2 - x^2 = \frac{3}{4}A^2$$

$$\Rightarrow x^2 = \frac{A^2}{4}$$

$$\Rightarrow x = \frac{A}{2}$$

Question: A capacitor of capacitance $100\mu F$ discharges through a resistor R . At the same time a radioactive substance decays with mean life 30 ms. If ratio of charge on capacitor to activity of substance does not change with time, then find R .

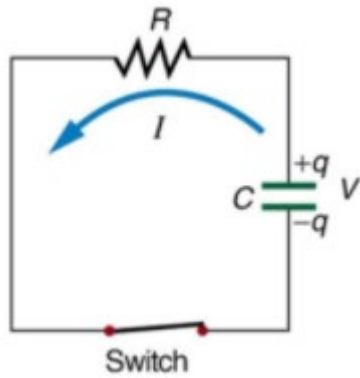

Options:

- (A) 300Ω
- (B) 100Ω
- (C) 200Ω
- (D) 400Ω

Answer: (A)

Solution:

$$\frac{Q}{A} = \frac{Q_0 e^{-t/RC}}{A_0 e^{-\lambda t}} \text{ (ratio is time independent)}$$

$$\lambda = \frac{1}{RC}, \quad RC = \frac{1}{\lambda} = T_{\text{mean}} \text{ (mean life)}$$

$$R = \frac{T_{\text{mean}}}{C} = \frac{30 \times 10^{-3}}{100 \times 10^{-6}} = 300\Omega$$

Question: Three balls A, B and C of masses m , $2m$ and $2m$ respectively are placed on a smooth horizontal

surface. A is initially moving with velocity 9 m/s , collides elastically with B (initially at rest), which in turn collides

inelastically with C (initially at rest). Assuming all collisions to be head on, final velocity of C is

Options:

- (A) $\frac{9}{2} (m/s)$
- (B) $9 (m/s)$
- (C) $6 (m/s)$
- (D) $3 (m/s)$

Answer: (D)

Solution:

For collision between A and B

$$m_A = m, m_B = 2m, u_A = 9\text{ m/s}, u_B = 0, v_B = ?$$

$$v_B = \frac{2m_A u_A}{m_A + m_B} - \left(\frac{m_A - m_B}{m_A + m_B} \right) u_B$$

$$= \frac{2 \times m \times 9}{m + 2m} - 0 = 6m/s$$

For collision between B and C

$$m_B = 2m, m_C = 2m, u_B = 6m/s, u_C = 0, v = ?$$

$$m_B u_B + m_C u_C = (m_B + m_C) v$$

$$2m \times 6 + 0 = 4mv$$

$$\Rightarrow v = \frac{12}{4} = 3m/s$$

Question: A particle of mass $9.1 \times 10^{-31} \text{ kg}$ moving with a velocity 10^6 m/s has de Broglie wavelength λ_1 . A

photon of momentum 10^{-27} kgm/s has wavelength λ_2 . Find $\frac{\lambda_2}{\lambda_1}$

Options:

(A) 910

(B) 667

(C) $\frac{1}{310}$

(D) 1

Answer: (A)

$$\text{Solution: } \frac{\lambda_2}{\lambda_1} = \frac{h/p}{h/mv} = \frac{mv}{p} = \frac{9.1 \times 10^{-31} \times 10^6}{10^{-27}} = 910$$

Question: Two disks having same surface mass density have radii r and R .

$I_1 \rightarrow$ Moment of inertia of 1st disk about an axis perpendicular to the plane and passing through centre.

$I_2 \rightarrow$ Moment of inertia of 2nd disk about one of its diameters. Find $\frac{I_1}{I_2}$ Memory based questions

Options:

(A) $\frac{r^4}{R^4}$

(B) $\frac{2r^4}{R^4}$

(C) $\frac{r^4}{2R^4}$

(D) $\frac{2r^2}{R^4}$

Answer: (B)

Solution:

Moment of inertia of a disc about its center perpendicular to the plane of the disc is $\frac{MR^2}{2}$

& Moment of inertia of a disc about one of its diameters is $\frac{MR^2}{4}$

Now both discs have same surface mass density (σ) (say)

then mass of 1st disc with radius $r = (\pi r^2)\sigma$

$$\therefore \text{M.I of disc 1 about center, } \perp \text{ to the plane} = \frac{mr^2}{2} = (\pi r^2)\sigma \frac{r^2}{2}$$

$$= \frac{\pi\sigma r^4}{2} = I_1$$

mass of 2nd disc with radius $R = (\pi R^2)\sigma$

$$\therefore \text{M.I of 2nd disc about one of its diameters is } \frac{mR^2}{4}$$

$$= (\pi R^2)\sigma \frac{R^2}{4} = I_2 = \frac{\pi R^4 \sigma}{4}$$

$$\frac{I_1}{I_2} = \frac{\left(\frac{\pi\sigma r^4}{2}\right)}{\frac{\pi\sigma R^4}{4}}$$

$$= \frac{2r^4}{R^4}$$

Question: Two capacitor C_1 with capacitor $2C$, and C_2 with capacitance C are connected in parallel. They are charged and then the battery is removed. If a material of dielectric constant K is inserted in

C_2 , find final potential across them

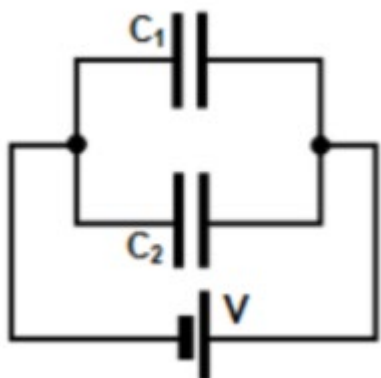

Options:

(A) KV

(B) $\frac{3V}{K+2}$

(C) $\frac{V}{K}$

(D) $\frac{3}{KV}$

Answer: (B)

Solution:

Both are in parallel, so p.d across them will be same.

$$Q_1 = C_1V = (2C)V = 2CV$$

$$Q_2 = C_2V = CV$$

$$\text{Total charge} = 3CV$$

When dielectric is inserted in it's capacitance becomes KC .

If V' is final common potential, then since total charge remains unchanged

$$Q_{1f} + Q_{2f} = Q_1 + Q_2 = 3CV$$

$$2C(V') + (KC)V' = 3CV$$

$$V' = \left(\frac{3V}{2+k} \right)$$

Question: Pressure of a monatomic gas in a container is 2 atm. Average kinetic energy per molecule is $2 \times 10^{-9} J$.

Volume of gas is 1 litre. Find number of molecules of gas present in the container.

Options:

(A) $\frac{3}{2} \times 10^{11}$

(B) $\frac{3}{2} \times 10^{10}$

(C) $\frac{5}{2} \times 10^{12}$

(D) $\frac{5}{2} \times 10^{11}$

Answer: (A)

Solution:

No, of molecules = no of moles $\times N_A$

$$= n \times N_A$$

$$n = \frac{PV}{RT} = \frac{PV}{N_A kT}$$

Given avg. kinetic energy = $2 \times 10^{-9} J$

$$\therefore \frac{3}{2} kT = 2 \times 10^{-9}$$

$$\therefore kT = \frac{4 \times 10^{-9}}{3}$$

Now given 2 atm pressure

$$\therefore P = 2 \times 1.013 \times 10^5 N / m^2$$

Volume = 1 litre = $10^{-3} m^3$

$$\text{No of molecules} = \frac{PV}{N_A kT} \times N_A$$

$$= \frac{PV}{kT}$$

$$= \frac{2 \times 1.013 \times 10^5 \times 10^{-3}}{4/3 \times 10^{-9}}$$

$$\approx \frac{3}{2} \times 10^{11}$$

Question: If $V_A = V_0; V_B = 3.5V_0, V_C = 5.5V_0, V_D = 1.5V_0, P_A = 9P_0, P_D = P_0$ in the given indicator diagram, choose

correct option

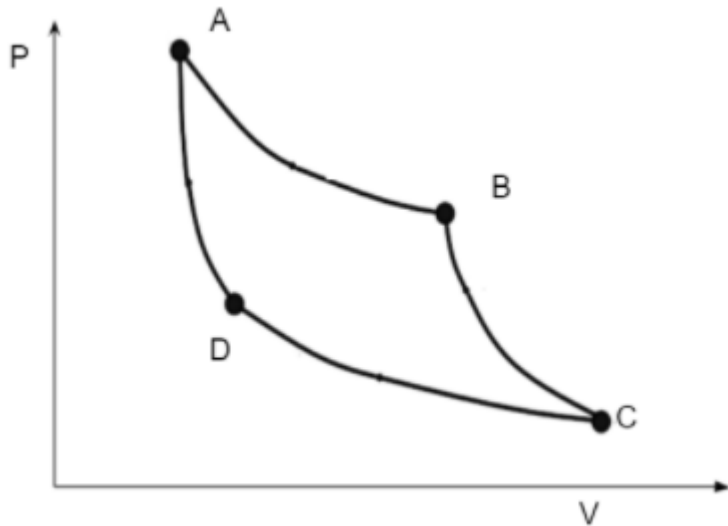

Options:

- (A) $W_{AB} < W_{CD}$
- (B) $W_{AB} = W_{CD}$
- (C) $W_{BC} + W_{DA} > 0$
- (D) $W_{BC} = W_{AD}$

Answer: (D)

Solution:

$A \rightarrow B$ and $D \rightarrow C$ are isotherms

So, $T_A = T_B$ & $T_C = T_D$

Now, $B \rightarrow C$ and $D \rightarrow A$ are adiabatic

$$\therefore |W_{BC}| = \frac{nR}{r-1} (T_B - T_C)$$

$$|W_{AD}| = \frac{nR}{r-1} (T_A - T_D) - \frac{nR}{r-1} (T_B - T_C)$$

$$\therefore W_{BC} = W_{AD}$$

Question: Two point charges are suspended from a given point as shown in the figure. Find the equilibrium separation between them

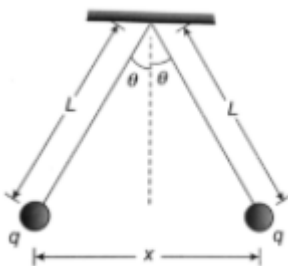

Options:

(a) $q\sqrt{\frac{4\pi\epsilon_0}{mg \tan \theta}}$

(b) $q\sqrt{\frac{\cot \theta}{4\pi\epsilon_0 mg}}$

(c) $q\sqrt{\frac{\sin \theta}{mg 4\pi\epsilon_0}}$

(d) $q\sqrt{\frac{\cos \theta}{4\pi\epsilon_0 mg}}$

Answer: (b)

Solution:

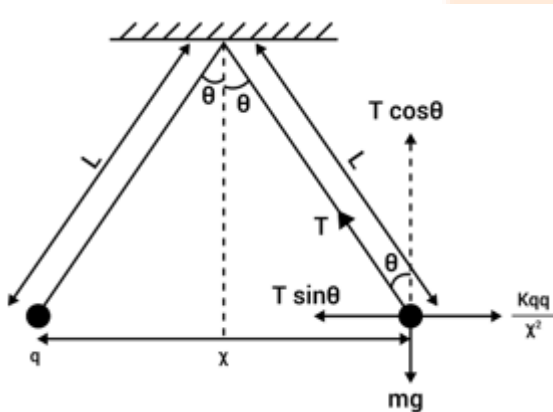

$$T \sin \theta = \frac{Kq^2}{x^2} \dots(i)$$

$$T \cos \theta = mg \dots(ii)$$

From eq (i) and (ii)

$$\tan \theta = \frac{Kq^2}{x^2} \cdot \frac{1}{mg}$$

$$x = \sqrt{\frac{Kq^2}{mg \tan \theta}}$$

$$x = q\sqrt{\frac{\cot \theta}{4\pi\epsilon_0 mg}}$$

Question: The switch is closed at $t = 0$. Find time after which voltage across capacitor becomes 50 volt. [take $\ln 2 = 0.6$]

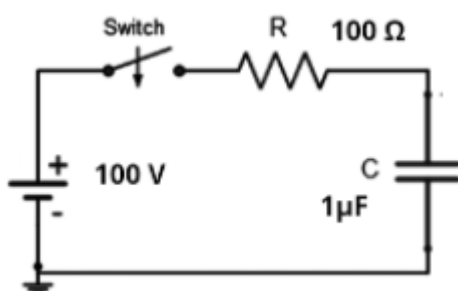

Options:

- (a) $100\mu s$
- (b) $60\mu s$
- (c) $80\mu s$
- (d) $70\mu s$

Answer: (b)

Solution:

$$V = V_0 \left(1 - e^{-\frac{t}{RC}} \right)$$

$$50 = 100 \left(1 - e^{-\frac{t}{RC}} \right)$$

$$\frac{1}{2} = 1 - e^{-\frac{t}{RC}}$$

$$e^{-\frac{t}{RC}} = \frac{1}{2}$$

$$\frac{t}{RC} = \ln 2$$

$$t = RC \ln 2$$

$$t = 100 \times 1 \times 10^{-6} \times 0.6$$

$$t = 60\mu s$$

Question: Equivalent capacitance of following arrangement of identical parallel plates is

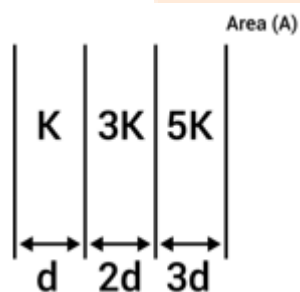

Options:

- (a) $\frac{25k\epsilon_0 A}{6d}$
- (b) $\frac{6k\epsilon_0 A}{25d}$
- (c) $\frac{15k\epsilon_0 A}{34d}$
- (d) $\frac{2k\epsilon_0 A}{15d}$

Answer: (c)

Solution:

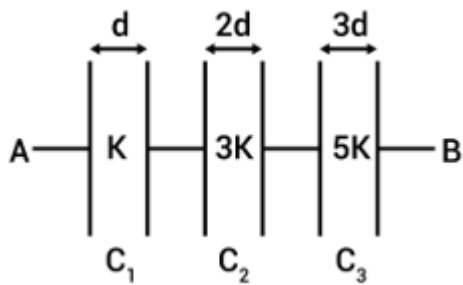

$$\frac{1}{C_{eq}} = \frac{1}{C_1} + \frac{1}{C_2} + \frac{1}{C_3}$$

$$\frac{1}{C_{eq}} = \frac{d}{\epsilon_0 AK} + \frac{2d}{\epsilon_0 A3K} + \frac{3d}{\epsilon_0 A5K}$$

$$\frac{1}{C_{eq}} = \frac{d}{\epsilon_0 AK} \left\{ 1 + \frac{2}{3} + \frac{3}{5} \right\}$$

$$\frac{1}{C_{eq}} = \frac{d}{\epsilon_0 AK} \times \frac{34}{15}$$

$$C_{eq} = \frac{15\epsilon_0 AK}{34d}$$

Question: Young's modulus of a string is $0.5 \times 10^9 \text{ Pa}$, length of the wire without any force applied in 0.1 m and area is $0.04 \times 10^{-4} \text{ m}^2$. If this wire is stretched by a length of 0.001 m. The energy stored in this string is transferred to a particle of mass 20 grams. Find speed of the particle

Options:

- (a) 1 m/s
- (b) 0.5 m/s
- (c) 2 m/s
- (d) 0.25 m/s

Answer: (a)

Solution:

Young's modulus $Y = 0.5 \times 10^9 \text{ pa}$

$\ell = 0.1 \text{ m}$

$A = 0.04 \times 10^{-4} \text{ m}^2$

$\Delta \ell = 0.001 \text{ m}$

$m = 20 \text{ g} = 20 \times 10^{-3}$

Energy stored in the string due to extension = $\frac{1}{2} \sigma \epsilon \times \text{volume}$

$$= \frac{1}{2} Y \epsilon^2 \cdot \text{volume}$$

From energy conservation

$$\frac{1}{2} mu^2 = \frac{1}{2} Y \epsilon^2 \times \text{volume}$$

$$20 \times 10^{-3} \times u^2 = 0.5 \times 10^9 \times \left(\frac{0.001}{0.1} \right)^2 \times 0.04 \times 10^{-4} \times 0.1$$

$$2 \times 10^{-2} u^2 = 2 \times 10^{-2}$$

$$u^2 = 1$$

$$u = 1 \text{ m/s}$$

Question: In a YDSE setup, orange light is replaced by blue light. Then,

Options:

- (a) Fringe width will increase
- (b) Fringe width will decrease
- (c) At center, instead of maxima, there would be a minima
- (d) The intensity of central maxima will decrease

Answer: (b)

Solution:

$$\text{Fringe width } \beta = \frac{\lambda D}{d}$$

$$\lambda_{\text{orange}} > \lambda_{\text{blue}}$$

$$\beta_{\text{orange}} \propto \lambda_{\text{orange}} \dots \text{(i)}$$



$$\beta_{\text{blue}} \propto \lambda_{\text{blue}} \dots \text{(ii)}$$

From (i) and (ii)

$$\frac{\beta_{\text{blue}}}{\beta_{\text{orange}}} = \frac{\lambda_{\text{blue}}}{\lambda_{\text{orange}}}$$

$$\beta_{\text{blue}} < \beta_{\text{orange}}$$

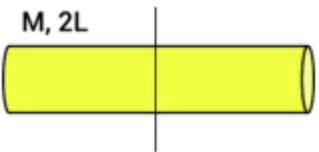
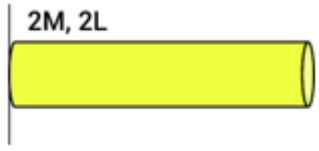
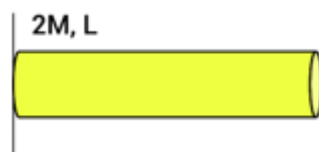
Question: Match the moment of inertia of the rods with given mass and length in column A about the given axis.

A		i	$\frac{8}{3} ML^2$
B		ii	$\frac{ML^2}{3}$
C		iii	$\frac{2ML^2}{3}$
D		iv	$\frac{ML^2}{12}$

Options:

- (a) A(iv), B(iii), C(ii), D(i)
 (b) A(ii), B(iii), C(iv), D(i)
 (c) A(iii), B(ii), C(iv), D(i)
 (d) A(ii), B(iv), C(i), D(iii)

Answer: (a)

Solution:

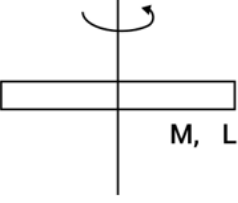
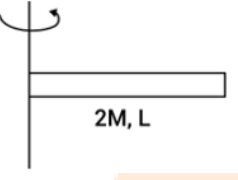
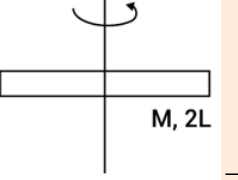
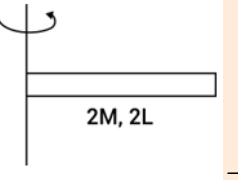
A	 $\rightarrow \frac{ML^2}{12}$
B	 $\rightarrow \frac{2ML^2}{3} = 2\frac{ML^2}{3}$
C	 $\rightarrow \frac{M(2L)^2}{12} = \frac{ML^2}{3}$
D	 $\rightarrow \frac{2M \cdot (2L)^2}{3} = \frac{8ML^2}{3}$

A(iv), B(iii), C(ii), D(i)

Question: A cylindrical massless container of cross-sectional area 'A' have a fluid filled upto height 'h' and have a small orifice of area 'a' in wall near its bottom. Find minimum coefficient between container and ground, so that container does not move.

Options:

- (a) $\frac{2a}{A}$
 (b) $\frac{a}{2A}$
 (c) $\frac{A}{a}$
 (d) None

Answer: (a)

Solution:

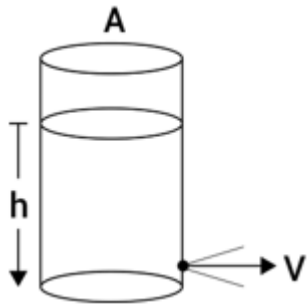

$$v = \sqrt{2gh} \text{ as } a \ll A$$

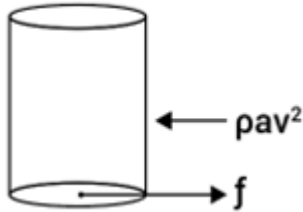

Thrust on container is ρav^2

where

$\rho \rightarrow$ density

$a \rightarrow$ area of cross section of orifice

$v \rightarrow$ speed of fluid

$f \rightarrow$ force of friction.

$$f \leq f_L$$

$$f \leq \mu mg$$

$$f \leq \mu \rho Ah \cdot g$$

For

$$\rho av^2 \leq \rho Ahg \times \mu$$

Container does not move

$$\rho a \times 2gh \leq \rho Ahg \times \mu$$

$$\frac{2a}{A} \leq \mu$$

$$\mu_{\min} = \frac{2a}{A}$$

Question: Two prisms P_1 and P_2 whose refractive index as a function of wavelength λ are μ_1 and

$$\mu_2 \text{ respectively where } \mu_1 = 1.2 + \frac{10.8 \times 10^{-14}}{\lambda^2} \text{ and } \mu_2 = 1.45 + \frac{1.8 \times 10^{-14}}{\lambda^2}.$$

Find λ for which when P_1 and P_2 are put together, no deviation of light happened in the contact surface.

Assume both the prism are thin, and both having refracting angle $A=4^\circ$

Options:

(a) 900 nm

(b) 600 nm

(c) 800 nm

(d) 700 nm

Answer: (b)

Solution:

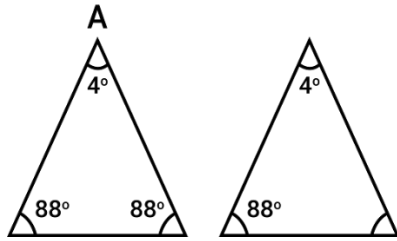

$$\mu_1 = 1.2 + \frac{10.8 \times 10^{-14}}{\lambda^2}$$

$$\mu_2 = 1.45 + \frac{1.8 \times 10^{-14}}{\lambda^2}$$

$$\delta_1 + \delta_2 = 0 \quad \text{for the system.}$$

$$\delta_1 = (\mu_1 - 1) A_1$$

$$\delta_2 = (\mu_2 - 1) A_2$$

$$\delta_1 + \delta_2 = \mu_1 A_1 - A_1 + \mu_2 A_2 - A_2 = 0$$

$$\frac{(\mu_1 - 1)}{(\mu_2 - 1)} = \frac{A_2}{A_1}$$

$$\frac{1.2 + \frac{10.8 \times 10^{-14}}{\lambda^2} - 1}{1.45 + \frac{1.8 \times 10^{-14}}{\lambda^2} - 1} = + \frac{A_2}{A_1}$$

$$\frac{0.2 + \frac{10.8 \times 10^{-14}}{\lambda^2}}{0.45 + \frac{1.8 \times 10^{-14}}{\lambda^2}} = + \frac{A_2}{A_1}$$

on solving

$$\lambda = 600 \text{ nm}$$

Question: Two planets A and B of masses M and 9 M with radii R and 2 R respectively are present 8 R distance away from each other. Minimum velocity with which a particle is projected from surface

of A such that it reaches plane B is given by $\sqrt{\frac{aGM}{7R}}$. Value of 'a' is

Answer: (4)

Solution:

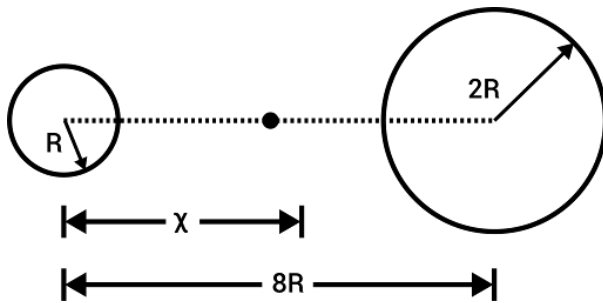

We have to find the point where the gravitational field must be zero. This is because after that point particle itself pulled by greater mass, no need to give any amount of kinetic energy.

$$E_G = 0$$

$$\frac{GM}{x^2} = \frac{GM \times q}{(8R - x)^2}$$

$$\frac{(8R - x)^2}{x^2} = 9$$

$$\frac{8R - x}{x} = 3 \Rightarrow 8R - x = 3x$$

$$\boxed{x = 2R}$$

Potential at A

$$V_A = -\frac{GM}{R} - \frac{G9M}{7R} = -\frac{16GM}{7R}$$

Potential at point x distance apart from A

$$V_x = -\frac{GM}{2R} - \frac{G9M}{6R} = -\frac{12GM}{6R}$$

$$= -\frac{2GM}{R}$$

Potential difference is

$$\Delta V = V_x - V_A = -\frac{2GM}{R} + \frac{16GM}{7R} = \frac{2GM}{7R}$$

Applying conservation of energy principle

$$\Delta KE = \Delta U$$

$$\frac{1}{2}mV^2 = m\Delta V$$

$$\frac{1}{2}mV^2 = \frac{2GMm}{7R}$$

$$V = \sqrt{\frac{4GM}{7R}}$$

$$a = 4$$

JEE-Main-27-07-2021-Shift-1 (Memory Based)

CHEMISTRY

Question: In the following reaction find 'B'

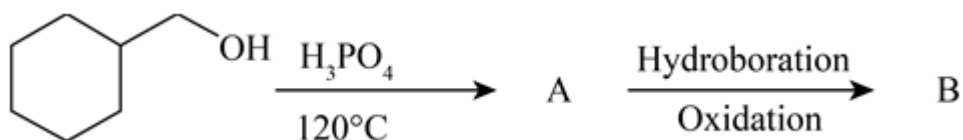

Options:

(a)

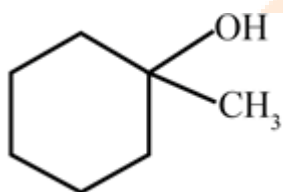

(b)

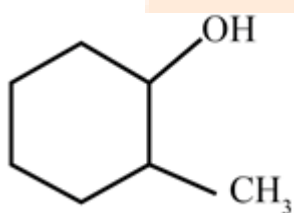

(c)

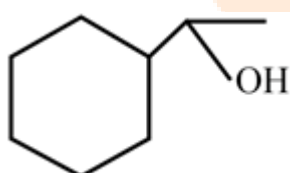

(d)

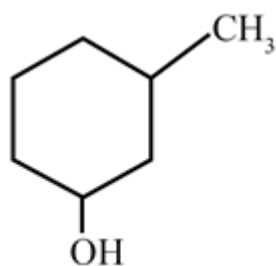

Answer: (b)

Solution:

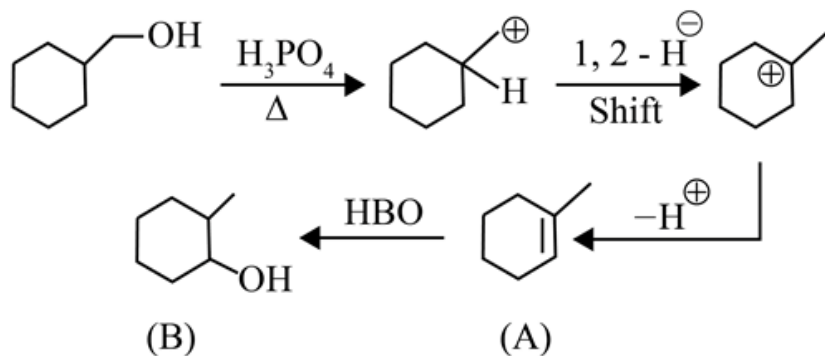

Question: If density of aqueous NaOH solution is 1.2 g/cm^3 , then find its molality.

[Given that: density of water = 1 gm/cm^3 and molar mass of NaOH = 40 gm]

Options:

- (a) 5 M
- (b) 10 M
- (c) 15 M
- (d) 20 M

Answer: (a)

Solution:

Let the volume of solution = 1000 cm^3

\therefore Weight of solution = 1200 g

Now, weight of water in the solution = 1000 g

Thus weight of NaOH = 200 g

\therefore Moles of NaOH = $\frac{200}{40} = 5$

Thus, molarity = $\frac{5}{1} = 5 \text{ M}$

Question: Difference between bond order of CO and NO^+ is $x/2$. Find x.

Options:

- (a) 1
- (b) 0
- (c) 2
- (d) 0.5

Answer: (b)

Solution: Electron is removed from anti-bonding of NO (bond order = 2.5) hence bond order increases by 0.5 hence NO^+ has bond order 3 and so does CO. The difference is zero

Question: $\text{CH}_3\text{-I} + \text{I}_2 \rightleftharpoons \text{CH}_4 + \text{HI}$

Which reagent can stop backward reaction?

Options:

- (a) Dilute HNO_2
- (b) Conc. HIO_3
- (c) HClO
- (d) $\text{NH}_3(\text{aq})$

Answer: (b)

Solution: $5\text{HI} + \text{Conc. HIO}_3 \rightarrow 3\text{I}_2 + 3\text{H}_2\text{O}$

Question: Which of the following is incorrect about Ellingham diagram?

Options:

- (a) Graph gives idea about rate of reaction
- (b) Graph gives idea about reduction of metal oxide
- (c) Graph gives idea about free energy change
- (d) Graph gives idea about phase change

Answer: (a)

Solution: Ellingham diagram does not give any information about rate of reaction

Question: Oxidation state of Phosphorus in $\text{H}_4\text{P}_2\text{O}_7$; $\text{H}_4\text{P}_2\text{O}_6$ and $\text{H}_4\text{P}_2\text{O}_5$ is respectively:

Options:

- (a) +5, +4 and +3 respectively
- (b) +5, +5 and +3 respectively
- (c) +3, +4 and +5 respectively
- (d) +7, +4 and +4 respectively

Answer: (a)

Solution:

$$\text{H}_4\text{P}_2\text{O}_7: 4 + 2x - 14 = 0$$

$$\Rightarrow 2x - 10 = 0$$

$$\Rightarrow 2x = 10$$

$$\Rightarrow x = +5$$

$$\text{H}_4\text{P}_2\text{O}_6: \Rightarrow 4 + 2x - 12 = 0$$

$$\Rightarrow 2x - 8 = 0$$

$$\Rightarrow 2x = 8$$

$$\Rightarrow x = +4$$

$$\text{H}_4\text{P}_2\text{O}_5: 4 + 2x - 10 = 0$$

$$\Rightarrow 2x - 6 = 0$$

$$\Rightarrow 2x = 6$$

$$\Rightarrow x = +3$$

Question: Arrange the increasing order of stability order of the following:

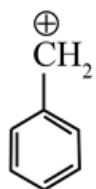

(i)

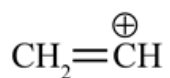

(ii)

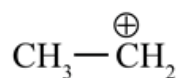

(iii)

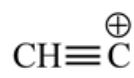

(iv)

Options:

(a) i > iii > ii > iv

(b) ii > iii > i > iv

(c) iii > ii > i > iv

(d) iv > ii > iii > i

Answer: (a)

Solution:

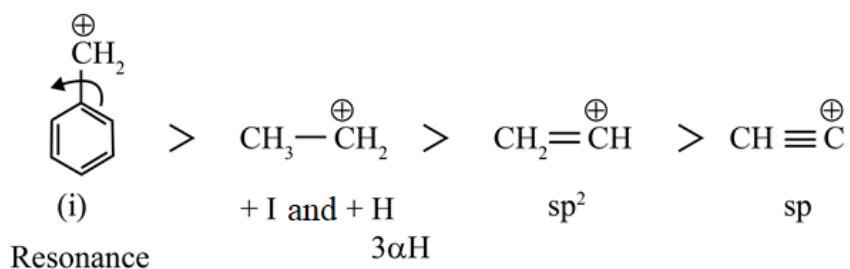

Question: A: Aniline is less basic than acetamide.

R: Lone pair of N in aniline is involved in resonance.

Options:

- (a) Both Assertion and Reason are correct.
- (b) Assertion is correct and Reason is incorrect
- (c) Assertion is incorrect but Reason is correct.
- (d) Both Assertion and Reason are incorrect.

Answer: (c)

Solution: Acetamide is less basic than aniline because its lone pair of Nitrogen atoms is involved in resonance with oxygen atom hence it is less available to donate

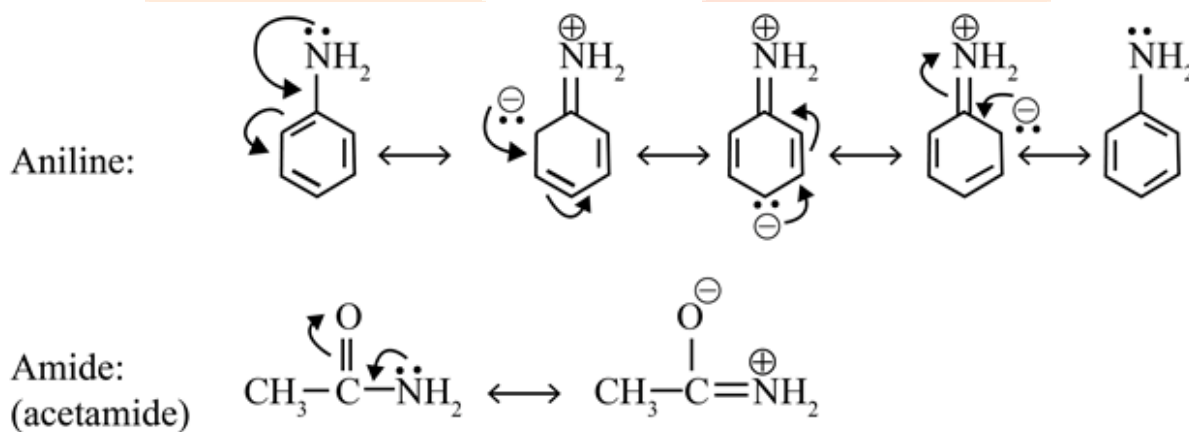

Question: S1: Halides of Lithium are generally covalent.

S2: Lithium has high polarisability.

Options:

- (a) Both S1 and S2 are correct.
- (b) S1 is correct but S2 is incorrect.

(c) S1 is incorrect but S2 is correct.

(d) Both S1 and S2 are incorrect.

Answer: (b)

Solution: Lithium halides are somewhat covalent. It is because of the high polarisation capability of lithium ion (The distortion of electron cloud of the anion by the cation is called polarisation). The Li^+ ion is very small in size and has high tendency to distort electron cloud around the negative halide ion. Since anion with large size can be easily distorted, among halides, lithium iodide is the most covalent in nature.

Polarisability is defined for anion

Question: S1: Rutherford's gold foil experiment didn't explain hydrogen spectrum.

S2: Bohr's model contradicted Heisenberg's uncertainty principle.

Options:

(a) Both S1 and S2 are correct.

(b) S1 is correct but S2 is incorrect.

(c) S1 is incorrect but S2 is correct.

(d) Both S1 and S2 are incorrect.

Answer: (a)

Solution: Both given statement are correct.

Question: Staggered and eclipsed form of ethane are:

Options:

(a) Rotamers

(b) Enantiomers

(c) Mirror images

(d) Polymers

Answer: (a)

Solution: Rotamers are any of a number of isomers of a molecule which can be inter converted by rotation of part of the molecule about a particular bond.

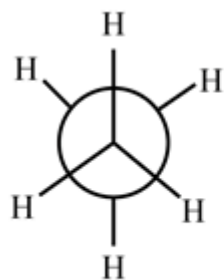

Staggered

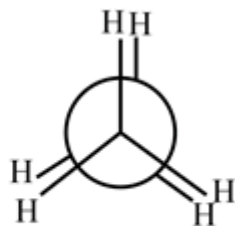

Eclipsed

Staggered and Eclipsed form of ethane are inter convertible by rotation of the molecule about a bond. Hence these are rotamers.

Question: $\text{PCl}_5 \rightleftharpoons \text{PCl}_3 + \text{Cl}_2$, $K_c = 1.844$

If 3 moles of PCl_5 are taken in 1 L vessel. Find equilibrium concentration of PCl_5 .

Options:

- (a) 3.4 M
- (b) 2.4 M
- (c) 1.4 M
- (d) 4.4 M

Answer: (c)

Solution:

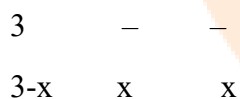

$$\frac{x^2}{3-x} = 1.844$$

$$\Rightarrow x^2 = 5.532 - 1.844x$$

$$\Rightarrow x^2 + 1.844x - 5.532 = 0$$

$$\Rightarrow x = 1.6 \text{ M}$$

$$\therefore \text{Concentration of } \text{PCl}_5 \text{ at equilibrium} = 3 - x = 3 - 1.6 = 1.4 \text{ M}$$

Question: Decomposition of N_2O_5 is a _____ order reaction

Options:

- (a) Zero

- (b) First
- (c) Second
- (d) Pseudo-first

Answer: (b)

Solution: Decomposition of N_2O_5 is an example of first order reaction

Question: Which gives orange colour with 2,4 DNP?

Options:

(a)

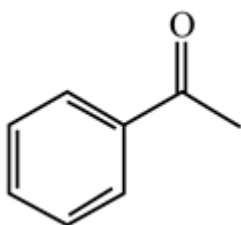

(b)

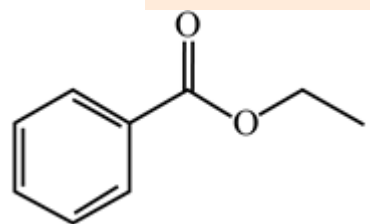

(c)

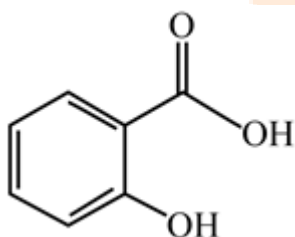

(d)

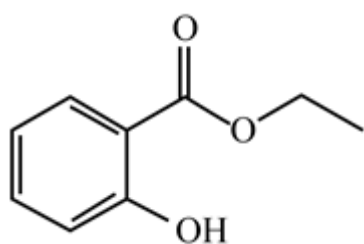

Answer: (a)

Solution: 2,4-dinitrophenyl hydrazine solution is used to detect ketones and aldehydes. A positive test is confirmed by the formation of a yellow, orange or red precipitate.

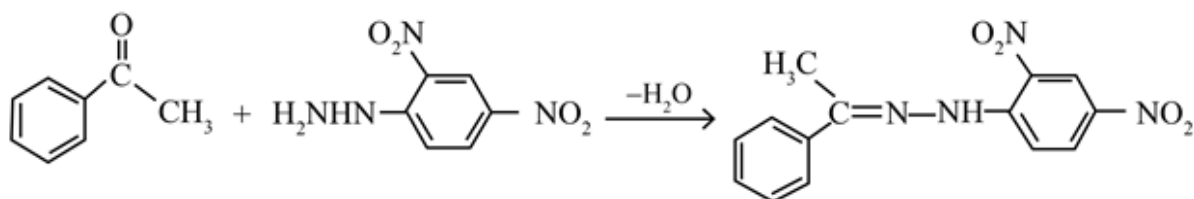

Question: Electrolysis of sulphate compound solution will give:

Options:

- (a) $\text{HO}_3\text{SOOSO}_3\text{H}$
- (b) $\text{HO}_2\text{SOOSO}_2\text{H}$
- (c) $\text{HO}_2\text{SOSO}_2\text{H}$
- (d) $\text{HO}_3\text{SOSO}_3\text{H}$

Answer: (a)

Solution: $2\text{SO}_4^{2-} \xrightarrow{\text{electrolysis}} \text{S}_2\text{O}_8^{2-} + 2\text{e}^-$

$\text{H}_2\text{S}_2\text{O}_8$:

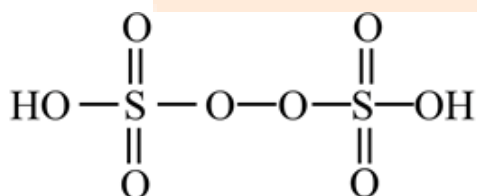

Question: Match the column.

Column I	Column II
1. Arsphenamine	(A) Antibiotic
2. Valium	(B) Tranquilizer
3. Furacine	(C) Antiseptic
	(D) Synthetic antihistamine

Options:

- (a) 1 → A; 2 → B; 3 → C
- (b) 1 → B; 2 → D; 3 → C
- (c) 1 → D; 2 → B; 3 → A

(d) 1 → C; 2 → B; 3 → A

Answer: (a)

Solution:

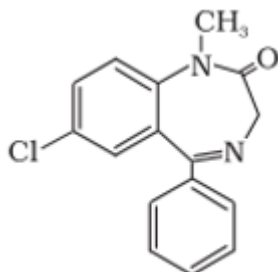

Valium

Tranquilizer

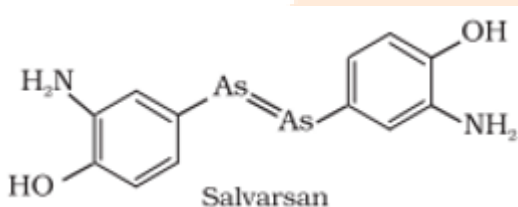

Salvarsan

Arsphenamine, known as a salvarsan used as Antibiotic

Antiseptics are applied to the living tissues such as wounds, cuts, ulcers and diseased skin surfaces. Examples are furacine, soframicine.

Question: Identify the incorrect statement?

Options:

- (a) Eutrophication pollutes water
- (b) Eutrophication increases oxygen level in water
- (c) Oxygen conc. is below 6 ppm, it is harmful for fish
- (d) None of these

Answer: (b)

Solution: Eutrophication is the process in which a water body becomes overly enriched with nutrients, leading to plentiful growth of simple plant life. The excessive growth (or bloom) of algae and plankton in a water body are indicators of this process.

The excessive growth of algae in entrap, water is accompanied by the generation of a lame biomass of dead algae. These dead algae sink to the bottom of the water body where they are broken down by bacteria, which consume oxygen in the process.

Question: In crystal system, $\alpha = \beta = 90^\circ$, $\gamma = 120^\circ$ and $a = 1.5$, $b = 2.5$ and $c = 3$. Find the crystal?

Options:

- (a) Monoclinic
- (b) Orthorhombic
- (c) Triclinic
- (d) Hexagonal

Answer: (a)

Solution: Given

$$\alpha = \beta = 90^\circ, \gamma \neq 120^\circ$$

$$a \neq b \neq c$$

Thus, crystal system is Monoclinic

Question: Which of the following is complementary base of the given structure in RNA?

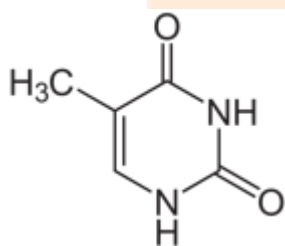

Options:

- (a) Uracil
- (b) Cytosine
- (c) Adenine
- (d) Guanine

Answer: (a)

Solution: DNA contains four base adenine(A), guanine(G), cytosine (C) and thymine (T). RNA also contains four bases, the first bases are same as in DNA but the fourth one is uracil (U).

Question: Match the column.

Column I	Column II
----------	-----------

(1) $\text{Be}(\text{OH})_2$	(A) Acidic
(2) $\text{B}(\text{OH})_3$	(B) Basic
(3) NaOH	(C) Amphoteric
(4) $\text{Ca}(\text{OH})_2$	
(5) $\text{Al}(\text{OH})_3$	

Options:

- (a) $1 \rightarrow \text{C}; 2 \rightarrow \text{A}; 3 \rightarrow \text{B}; 4 \rightarrow \text{B}; 5 \rightarrow \text{C}$
- (b) $1 \rightarrow \text{A}; 2 \rightarrow \text{C}; 3 \rightarrow \text{B}; 4 \rightarrow \text{A}; 5 \rightarrow \text{C}$
- (c) $1 \rightarrow \text{B}; 2 \rightarrow \text{A}; 3 \rightarrow \text{C}; 4 \rightarrow \text{A}; 5 \rightarrow \text{C}$
- (d) $1 \rightarrow \text{A}; 2 \rightarrow \text{C}; 3 \rightarrow \text{B}; 4 \rightarrow \text{B}; 5 \rightarrow \text{C}$

Answer: (a)

Solution:

$\text{Be}(\text{OH})_2 \Rightarrow$ Amphoteric

$\text{B}(\text{OH})_3 \Rightarrow$ Acidic

$\text{NaOH} \Rightarrow$ Basic

$\text{Ca}(\text{OH})_2 \Rightarrow$ Basic

$\text{Al}(\text{OH})_3 \Rightarrow$ Amphoteric

Question: How to differentiate between monosaccharides and disaccharides

Options:

- (a) Iodine test
- (b) Seliwanoff's test
- (c) Barfoed test
- (d) Tollen's test

Answer: (c)

Solution: Barfoed's test distinguishes monosaccharides from disaccharides. In this test, copper acetate in dilute acid is reduced in 30 seconds by monosaccharides whereas disaccharides take several minutes.

Question: If number of geometrical isomers of $[\text{Co}(\text{NH}_3)_3(\text{NO}_2)_3]$ is a and that of $(\text{Cr}(\text{C}_2\text{O}_4)_3)$ is b, then find $a + b$?

Answer: 3.00

Solution:



Total geometric isomerism = 2

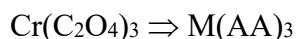

Total geometric isomerism = 1

Thus, total = 3

* Please note that $\text{Cr}(\text{C}_2\text{O}_4)_3$ can exist in one form only and examiner might not consider it as geometric isomerism

Question: According to $x/m = kp^{1/n}$, when pressure is increased 2 times, the concentration becomes 64 times. Find the value of n [in terms of 10^{-2}] (Round off to nearest integer)

Answer: 17.00

Solution:

$$\frac{(x/m)_1}{(x/m)_2} = \left(\frac{p_1}{p_2} \right)^{1/n}$$

$$\Rightarrow \frac{1}{64} = \left(\frac{1}{2} \right)^{1/n}$$

$$\Rightarrow \frac{1}{n} = 6$$

$$\Rightarrow n = \frac{1}{6} = 0.167 = 16.7 \times 10^{-2} = 17$$

Question: The bond angle of C-N-C in $\text{N}(\text{Et})_3$ is (Round of the answer to the nearest integer.)

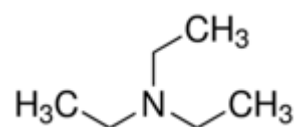

Answer: 111.00

Solution: Triethylamine is a base, like ammonia. Also like ammonia, it has a trigonal pyramidal structure. The C-N-C bond angle is 110.9° , compared with 107.2° in NH_3 , presumably due to greater repulsion between the ethyl groups



JEE-Main-27-07-2021-Shift-1 (Memory Based)

MATHEMATICS

Question: $\lim_{x \rightarrow 2} \frac{x^2 f(2) - 4f(x)}{(x-2)} =$

Where, $f(2) = 4f'(2) = 1$

Options:

- (a) 12
- (b) 16
- (c) 8
- (d) 10

Answer: (a)

Solution:

$$\begin{aligned} & \lim_{x \rightarrow 2} \frac{x^2 f(2) - 4f(x)}{x-2} \\ &= \lim_{x \rightarrow 2} \frac{2xf'(x) - 4f'(x)}{1} \\ &= 2 \times 2f'(2) - 4f'(2) \\ &= 2 \times 2 \times 4 - 4 \times 1 \\ &= 16 - 4 = 12 \end{aligned}$$

Question: If Coefficient of x^7 in $\left(x^2 + \frac{1}{bx}\right)^{11}$ and x^{-7} in $\left[x - \frac{1}{bx^2}\right]^{11}$, $b \neq 0$, are equal then

find b .

Options:

- (a) 1
- (b) -1
- (c) 2
- (d) -2

Answer: (a)

Solution:

$$\text{Coeff. of } x^7 \text{ in } \left(x^2 + \frac{1}{bx}\right)^{11} = \text{coeff. of } x^{-7} \text{ in } \left(x - \frac{1}{bx^2}\right)^{11}$$

$${}^{11}C_6 \frac{1}{b^5} = {}^{11}C_5 \frac{1}{b^6} \Rightarrow b = 1$$

Question: $\int_{-\frac{\pi}{4}}^{\frac{\pi}{4}} \frac{dx}{(1 + e^{x \cos x})(\sin^4 x + \cos^4 x)}$

Options:

(a) $\frac{\pi}{2(\sqrt{2})}$

(b) $\frac{\pi}{4(\sqrt{2})}$

(c) $\frac{\pi}{8(\sqrt{2})}$

(d) $\frac{\pi}{\sqrt{2}}$

Answer: (a)

Solution:

$$I = \int_{-\frac{\pi}{4}}^{\frac{\pi}{4}} \frac{dx}{(1 + e^{x \cos x})(\sin^4 x + \cos^4 x)} = \int_{-\frac{\pi}{4}}^{\frac{\pi}{4}} \frac{e^{x \cos x} dx}{(\sin^4 x + \cos^4 x)(1 + e^{x \cos x})}$$

$$\therefore I = \int_0^{\frac{\pi}{4}} \frac{dx}{\sin^4 x + \cos^4 x} = \int_0^{\frac{\pi}{4}} \frac{(\tan^2 x + 1) \sec^2 x dx}{(\tan^4 x + 1)}$$

$$I = \int_0^1 \frac{t^2 + 1}{t^4 + 1} dt = \int_0^1 \frac{\left(1 + \frac{1}{t^2}\right)}{\left(t - \frac{1}{t}\right)^2 + 2} dt$$

$$I = \int_{-\infty}^0 \frac{du}{u^2 + 2} = \left[\frac{1}{\sqrt{2}} \tan^{-1} \left(\frac{u}{\sqrt{2}} \right) \right]_{-\infty}^0 = \frac{\pi}{2\sqrt{2}}$$

Question: If α and β are the roots of equation $x^2 + 20^{\frac{1}{4}}x + 5^{\frac{1}{2}} = 0$ the find $(\alpha^8 + \beta^8)$

Options:

- (a) 100
- (b) 50
- (c) 200
- (d) 300

Answer: (b)

Solution:

$$x^2 + (20)^{\frac{1}{4}}x + (5)^{\frac{1}{2}} = 0$$

$$\alpha + \beta = -(20)^{\frac{1}{4}}, \alpha\beta = (5)^{\frac{1}{2}} \Rightarrow \alpha^2 + \beta^2 = (20)^{\frac{1}{2}} - 2(5)^{\frac{1}{2}} = 0$$

$$\alpha^4 + \beta^4 = -2 \times 5 = -10$$

$$\Rightarrow \alpha^8 + \beta^8 = 100 - 2 \times 25 = 50$$

Question: If $f(x) = \begin{cases} (1 + |\sin x|)^{\frac{3a}{|\sin x|}}, & \left(-\frac{\pi}{4}, 0\right) \\ b, & x = 0 \\ e^{\frac{\cot 4x}{\cot 2x}}, & x > 0 \end{cases}$. Find $6a + b^2$.

Options:

- (a) $1 + e$
- (b) $1 - e$
- (c) e
- (d) $e - 1$

Answer: (a)

Solution:

$$f(0^-) = f(0) + f(0^+) \Rightarrow e^{3a} = b = e^{\frac{1}{2}}$$

$$\therefore 3a = \frac{1}{2} \text{ and } b = e^{\frac{1}{2}} \Rightarrow 6a + b^2 = 1 + e$$

Question: If $\sin \theta + \cos \theta = \frac{1}{2}$, then find $16[\sin 2\theta + \cos 4\theta + \sin 6\theta]$

Options:

- (a) -27
- (b) -23

(c) 27

(d) 23

Answer: (b)

Solution:

$$\sin \theta + \cos \theta = \frac{1}{2}$$

$$\Rightarrow \sin^2 \theta + \cos^2 \theta + 2 \sin \theta \cos \theta = \frac{1}{4}$$

$$\Rightarrow 1 + \sin 2\theta = \frac{1}{4}$$

$$\Rightarrow \sin 2\theta = \frac{-3}{4}$$

$$\cos 4\theta = 1 - 2 \sin^2 2\theta = 1 - 2 \left(\frac{-3}{4} \right)^2$$

$$= 1 - 2 \left(\frac{9}{16} \right) = 1 - \frac{9}{8} = -\frac{1}{8}$$

$$\sin 6\theta = 3 \sin 2\theta - 4 \sin^3 2\theta$$

$$= 3 \times \left(\frac{-3}{4} \right) - 4 \left(\frac{-3}{4} \right)^3$$

$$= \frac{-9}{4} + \frac{27}{16} = \frac{-36 + 27}{16} = \frac{-9}{16}$$

$$16(\sin 2\theta + \cos 4\theta + \sin 6\theta)$$

$$= 16 \left[\frac{-3}{4} + \left(\frac{-1}{8} \right) + \left(\frac{-9}{16} \right) \right]$$

$$= -12 - 2 - 9 = -23$$

Question: The probability that a randomly selected 2-digit number belongs to the set

$\{n \in N : (2^n - 2) \text{ is a multiple of } 3\}$ is equal to

Options:

(a) $\frac{2}{3}$

(b) $\frac{1}{3}$

(c) $\frac{1}{2}$

(d) $\frac{1}{6}$

Answer: (c)

Solution:

$$\text{Total case} = \{10, 11, 12, \dots, 99\} = 90$$

$$(2^n - 2) = 3k \Rightarrow n = \{11, 13, 15, \dots, 99\} = 45$$

$$\therefore \text{Required probability} = \frac{45}{90} = \frac{1}{2}$$

Question: From point $(-1, 1)$ two tangents drawn to $x^2 + y^2 - 2x - 6y + 6 = 0$ that meet the circle A and B. A point D on the circle such that $AD = AB$. Find area of ΔABD .

Options:

(a) 2

(b) 4

(c) $2 + \sqrt{2}$

(d) 1

Answer: (b)

Solution:

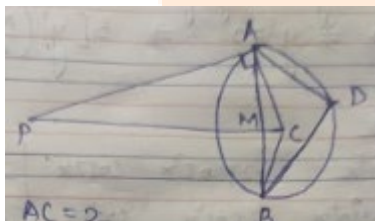

$$AP = 2$$

$$CP = 2\sqrt{2}$$

$$\angle CAP = 90^\circ, AC = 2$$

$$\therefore AC = AP \Rightarrow \angle ACP = \angle APC = 45^\circ$$

$$\Rightarrow \angle BAC = \angle ABC = 45^\circ \Rightarrow \angle BAD = 90^\circ$$

$$\text{Now, } \sin \angle APM = \frac{1}{\sqrt{2}} = \frac{AM}{AP} \Rightarrow AM = \frac{2}{\sqrt{2}} = \sqrt{2}$$

$$\therefore AB = AD = 2AM = 2\sqrt{2}$$

$$\therefore \text{Area of } \Delta ABD = \frac{1}{2} \times AB \times AD = 4$$

Question: Circle with centre (2, 3) passing through origin. P, Q are two points on the circle such that OC is perpendicular to both CP & CQ. Find points P & Q.

Options:

- (a) (4, 0), (0, 6)
- (b) (-1, 5), (5, 1)
- (c)
- (d)

Answer: (b)

Solution:

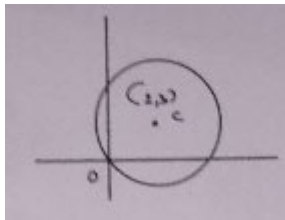

$$(x-2)^2 + (y-3)^2 = 2^2 + 3^2$$

$$(x-2)^2 + (y-3)^2 = 13$$

$$m_{oc} = \frac{3}{2} \quad m_{cp} = \frac{-2}{3}$$

$$\text{Equation of } cp = y-3 = \frac{-2}{3}(x-2)$$

$$\Rightarrow 3y-9 = -2x+4$$

$$\Rightarrow 3y+2x-13=0$$

$$\Rightarrow x = \frac{13-3y}{2}$$

Substituting in circle we get

$$\left(\frac{13-3y}{2}-2\right)^2 + (y-3)^2 = 13$$

$$\left(\frac{9-3y}{2}\right)^2 + (y-3)^2 = 13$$

$$81+9y^2-54y+4(y^2-6y+9)=52$$

$$81+9y^2-54y+4y^2-24y+36=52$$

$$13y^2-78y+117=52$$

$$13y^2-xy+65=0$$

$$y^2 - 6y + 5 = 0$$

$$y = 1, 5$$

$$x = \frac{13 - 3y}{2} = 5, -1$$

$$(x, y) \equiv (5, 1) \text{ and } (-1, 5)$$

Question: For the data 6, 10, 7, 13, a, 12, b, 12. If mean is 9, variance is $\frac{37}{4}$ find $(a - b)^2$.

Answer: 16.00

Solution:

$$\bar{x} = \frac{60 + a + b}{8} = 9 \Rightarrow a + b = 12$$

$$\sigma = \frac{642 + a^2 + b^2}{8} - 81 = \frac{37}{4} \Rightarrow a^2 + b^2 = 80$$

$$\therefore (a + b)^2 = a^2 + b^2 + 2ab \Rightarrow ab = 32$$

$$(a - b)^2 = a^2 + b^2 - 2ab = 16$$

Question: $\lim_{n \rightarrow \infty} \frac{1}{n} \sum_{j=1}^n \frac{2j - 1 + 8n}{2j - 1 + 4n}$

Answer: $1 + 2 \log\left(\frac{3}{2}\right)$

Solution:

$$\lim_{n \rightarrow \infty} \frac{1}{n} \sum_{j=1}^n \frac{2\left(\frac{j}{n}\right) + 8 - \left(\frac{1}{n}\right)}{2\left(\frac{j}{n}\right) + 4 - \left(\frac{1}{n}\right)} \quad \left\{ \because \lim_{n \rightarrow \infty} \frac{1}{n} = 0 \right\}$$

$$\Rightarrow \int_0^1 \frac{2x + 8}{2x + 4} dx = 1 + 4 \int_0^1 \frac{dx}{2x + 4} = [1 + 2 \log(2x + 4)]_0^1$$

$$= 1 + 2 \log\left(\frac{3}{2}\right)$$

Question: If $\log_3 2, \log_3(2^x - 5), \log_3\left(2x - \frac{7}{3}\right)$ are in an arithmetic progression then the value of x is equal to _____.

Answer: 3.00

Solution:

$$\log_3 2, \log_3 2^x - 5, \log_3 2^x - \frac{7}{2} \Rightarrow \text{AP}$$

$$\Rightarrow 2 \log_3 2^x - 5 = \log_3 2 + \log_3 2^x - \frac{7}{2}$$

$$\Rightarrow (2^x - 5)^2 = 2 \left(2^x - \frac{7}{2} \right)$$

Let $2^x = t$

$$\Rightarrow t^2 - 10t + 25 = 2t - 7$$

$$\Rightarrow t^2 - 12t + 32 = 0$$

$$\Rightarrow (t - 8)(t - 4) = 0$$

$$\Rightarrow t = 8, 4$$

But $2^x = 5$

$$\Rightarrow 2^x = 8$$

$$\Rightarrow x = 3$$

Question: Let $f(x) = \begin{vmatrix} \sin^2 x & -2 + \cos^2 x & \cos 2x \\ 2 + \sin^2 x & \cos^2 x & \cos 2x \\ \sin^2 x & \cos^2 x & 1 + \cos 2x \end{vmatrix}; x \in (0, \pi]$. Then the maximum

value of $f(x)$ is ?

Answer: 6.00

Solution:

$$f(x) = \begin{vmatrix} \sin^2 x & -2 + \cos^2 x & \cos 2x \\ 2 + \sin^2 x & \cos^2 x & \cos 2x \\ \sin^2 x & \cos^2 x & 1 + \cos 2x \end{vmatrix}$$

$$R_2 \rightarrow R_2 - R_1; R_3 \rightarrow R_3 - R_1$$

$$f(x) = \begin{vmatrix} \sin^2 x & -2 + \cos^2 x & \cos 2x \\ 2 & 2 & 0 \\ 0 & 2 & 1 \end{vmatrix}$$

$$f(x) = 2\sin^2 x + 4 - 2\cos^2 x + 4\cos 2x = 4 + 2\cos^2 x$$

$$f(x)_{\max} = 6$$

Question: $f(x) = \text{minimum} \{x - [x], 1 + [x] - x\} [0, 3] \rightarrow \mathbb{R}$, p is the number of points where it is discontinuous, q is the number of points where it is not differentiable. Find $p + q$.

Answer: 5.00

Solution:

$$f(x) = \min \{x - [x], 1 + [x] - x\} \quad x \in [0, 3]$$

$$= \min \{\{x\}, 1 - \{x\}\}$$

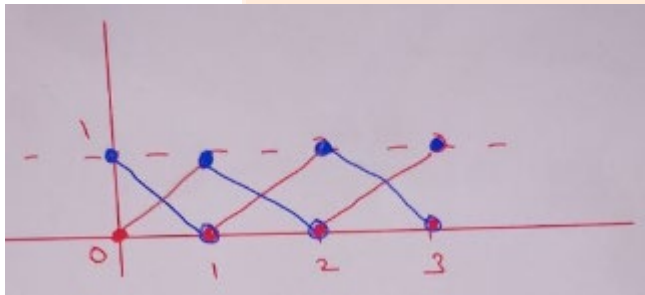

$f(x) \rightarrow$

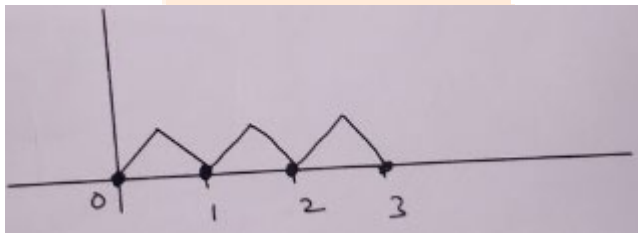

$$p = 0, q = 5$$

$$p + q = 5$$

Question: If $A = \begin{bmatrix} 1 & 2 \\ -1 & 4 \end{bmatrix}$, $A^{-1} = \alpha I + \beta A$, find $5(\alpha - \beta) = ?$

Answer: $\frac{9}{2}$

Solution:

$$A = \begin{bmatrix} 1 & 2 \\ -1 & 4 \end{bmatrix}; A^2 = \begin{bmatrix} 1 & 2 \\ -1 & 4 \end{bmatrix} \begin{bmatrix} 1 & 2 \\ -1 & 4 \end{bmatrix} = \begin{bmatrix} -1 & 10 \\ -5 & 14 \end{bmatrix}$$

$$\therefore I = \alpha A + \beta A^2 \Rightarrow \begin{bmatrix} 1 & 0 \\ 0 & 1 \end{bmatrix} = \begin{bmatrix} \alpha - \beta & 2\alpha + 10\beta \\ -\alpha - 5\beta & 4\alpha + 14\beta \end{bmatrix}$$

$$\therefore \alpha - \beta = 1, \alpha + 5\beta = 0$$

$$\Rightarrow \beta = \frac{-1}{6}, \alpha = \frac{5}{6} \Rightarrow 5\alpha - \beta = \frac{27}{6} = \frac{9}{2}$$

Question: Area enclosed by the figure: maximum $\{0, \log_e(x)\} \leq y \leq 2^x$ and $\frac{1}{2} \leq x \leq 2$.

Answer: ()

Solution:

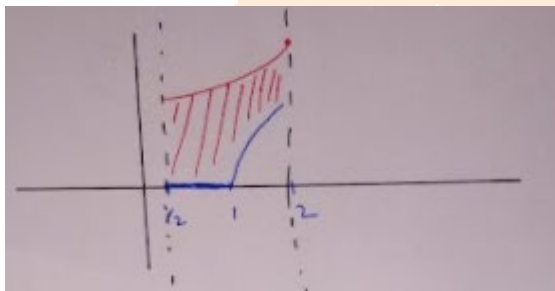

$$\text{Area} = \int_{\frac{1}{2}}^1 2^x dx + \int_1^2 (2^x - \ln x) dx$$

$$= 2^x \ln 2 \Big|_{\frac{1}{2}}^1 + 2^x \ln 2 \Big|_1^2 - (x \ln x - x) \Big|_1^2$$

$$= \left(2 \ln 2 - 2^{\frac{1}{2}} \ln 2 \right) - (2^2 \ln 2 - 2^1 \ln 2) - [(2 \ln 2 - 2) - (1 \ln 1 - 1)]$$

$$= 2 \ln 2 - \sqrt{2} \ln 2 + 4 \ln 2 - 2 \ln 2 - 2 \ln 2 + 2 = 1$$

$$= 2 \ln 2 - \sqrt{2} \ln 2 + 3$$

Question: $\vec{a} = \hat{i} + \hat{j} + 2\hat{k}$, $\vec{b} = -\hat{i} + 2\hat{j} + 3\hat{k}$

$$(\vec{a} + \vec{b}) \times \left((\vec{a} \times (\vec{a} - \vec{b})) \times \vec{b} \right)$$

Answer:

Solution:

$$\begin{aligned}
 & (\bar{a} + \bar{b}) \times (\bar{a} \times ((\bar{a} - \bar{b}) \times b)) \\
 &= (\bar{a} + \bar{b}) \times (\bar{a} \times (\bar{a} \times \bar{b} - \bar{b} \times \bar{b})) \\
 &= (\bar{a} + \bar{b}) \times (\bar{a} \times (\bar{a} \times \bar{b})) \\
 &= (\bar{a} + \bar{b}) \times ((\bar{a} \cdot \bar{b})\bar{a} - (\bar{a} \cdot \bar{a})\bar{b}) \\
 &= (-(\bar{a} \cdot \bar{a})(\bar{a} \times \bar{b}) + (\bar{a} \cdot \bar{b})(\bar{b} \times \bar{a})) \\
 &= (-6(\bar{a} \times \bar{b}) + (7)(\bar{b} \times \bar{a})) \\
 &= (6(\bar{b} \times \bar{a}) + 7(\bar{b} \times \bar{a}))
 \end{aligned}$$

$$\begin{aligned}
 &= 13(\bar{b} \times \bar{a}) = 13 \begin{vmatrix} \hat{i} & \hat{j} & \hat{k} \\ -1 & 2 & 3 \\ 1 & 1 & 2 \end{vmatrix} \\
 &= 13[\hat{i}(4-3) - \hat{j}(-2-3) + \hat{k}(-1-2)] \\
 &= 13[\hat{i} + 3\hat{j} - 3\hat{k}]
 \end{aligned}$$

Question: $\ln\left(\frac{dy}{dx}\right) = 3x + 4y$ and $y(0) = 0$. Find $y\left(\frac{-2}{3} \ln 2\right)$

Answer: ()

Solution:

$$\ln\left(\frac{dy}{dx}\right) = 3x + 4y$$

$$\frac{dy}{dx} = e^{3x+4y}$$

$$\frac{dy}{dx} = e^{3x+4y}$$

$$\frac{e^{-4y}}{-4} = \frac{e^{3x}}{3} + c$$

$$y(0) = 0$$

$$\Rightarrow \frac{-1}{4} = \frac{1}{3} + c$$

$$\Rightarrow c = \frac{-1}{4} - \frac{1}{3} = \frac{-7}{12}$$

$$\frac{e^{-4y}}{-4} = \frac{e^{3x}}{3} - \frac{7}{12}$$

$$\Rightarrow 3e^{-4y} = -4e^{3x} + 7$$

$$x = \frac{-2}{3} \ln 2$$

$$\Rightarrow 3e^{-4y} = -4e^{-2 \ln 2} + 7$$

$$\Rightarrow \frac{-1}{4} = \frac{1}{3} + c$$

$$\Rightarrow c = \frac{-1}{4} - \frac{1}{3} = \frac{-7}{12}$$

$$\frac{e^{-4y}}{-4} = \frac{e^{3x}}{3} - \frac{7}{12}$$

$$\Rightarrow 3e^{-4y} = -4e^{3x} + 7$$

$$x = \frac{-2}{3} \ln 2$$

$$\Rightarrow 3e^{-4y} = -4e^{-2 \ln 2} + 7$$

$$\Rightarrow 3e^{-4y} = -4 \times \frac{1}{4} + 7$$

$$\Rightarrow 3e^{-4y} = 6$$

$$\Rightarrow e^{-4y} = 2$$

$$\Rightarrow -4y = \ln 2$$

$$\Rightarrow y = -\frac{1}{4} \ln 2$$

Question: Let a plane p pass through the point $(3, 7, -9)$ and contain the line,

$\frac{x-2}{-3} = \frac{y-3}{2} = \frac{z-2}{1}$ or distance of the plane p from the origin d_1 then d_2 is equal to

_____.

Answer: ()

Solution:

Let plane be $ax + by + cz = d$

It passes through A(3, 7, -9)

$$\text{It contains } \frac{x-2}{-3} = \frac{y-3}{2} = \frac{z+2}{1}$$

\Rightarrow Plane passes through B(2, 3, -2)

$$\overrightarrow{AB} = -\hat{i} - 4\hat{j} + 7\hat{k}$$

$$\text{Normal to plane is } \begin{vmatrix} \hat{i} & \hat{j} & \hat{k} \\ -1 & -4 & 7 \\ -3 & 2 & 1 \end{vmatrix}$$

$$= \hat{i}(-4-14) - \hat{j}(-1+21) + \hat{k}(-2-12)$$

$$= -18\hat{i} - 20\hat{j} - 14\hat{k}$$

$$\vec{n} = 9\hat{i} + 10\hat{j} + 7\hat{k}$$

Equation of plane is $9x + 10y + 7z = d$

It passes through (3, 7, -9)

$$\Rightarrow 9 \times 3 + 10 \times 7 + 7 \times (-9) = d$$

$$\Rightarrow 27 + 70 - 63 = d$$

$$\Rightarrow 97 - 63 = d$$

$$\Rightarrow 34 = d$$

Plane is $9x + 10y + 7z = 34$

$$d^2 = \frac{34^2}{9^2 + 10^2 + 7^2} = \frac{34 \times 34}{230} = \frac{578}{115}$$

Question: If $\sec x \left(\frac{dy}{dx} \right) - \sin(x+y) - \sin(x-y) = 0$ and $y(0) = 0$. Find $5 \left[y' \left(\frac{\pi}{2} \right) \right]$.

Answer: 0.00

Solution:

$$\sec x \left(\frac{dy}{dx} \right) - \sin(x+y) - \sin(x-y) = 2 \sin x \cos y$$

$$\int \sec y \, dy = \int \sin 2x \, dx \Rightarrow \log(\sec y + \tan y) = \frac{-\cos 2x}{2} + c$$

At $x = 0, y = 0$

$$\therefore \sec y + \tan y = e^{\frac{1-\cos 2x}{2}} = e^{\sin^2 x}$$

$$\Rightarrow (\sec y \tan y + \sec^2 y) y' = e^{\sin^2 x} \sin 2x = 0$$

$$\Rightarrow y' = 0 \Rightarrow 5 \left[y' \left(\frac{\pi}{2} \right) \right] = 0$$



Thank You
for downloading the PDF

FREE LIVE ONLINE

MASTER CLASSES

FREE Webinars by Expert Teachers



Vedantu

FREE MASTER CLASS SERIES

- ✔ For **Grades 6-12th** targeting **JEE, CBSE, ICSE** & much more
- ✔ **Free 60 Minutes Live Interactive** classes everyday
- ✔ Learn from the **Master Teachers** - India's best

Register for **FREE**

Limited Seats!