

DATE : 12/09/2021



Test Booklet Code

M3

HAGAJA

Corporate Office : Aakash Tower, 8, Pusa Road, New Delhi-110005. Ph.: 011-47623456

Time : 3 hrs.

Answers & Solutions

Max. Marks : 720

for

NEET (UG) - 2021

Important Instructions :

1. The test is of **3 hours** duration and Test Booklet contains **200** multiple choice questions (Four options with a single correct answer). There are two sections in each subject, i.e. Section-A & Section-B. You have to attempt all 35 questions from Section-A & only 10 questions from Section-B out of 15. (**Candidates are advised to read all 15 questions in each subject of Section-B** before they start attempting the question paper. In the event of a candidate attempting more than ten questions, **the first ten questions answered by the candidate shall be evaluated.**)
2. Each question carries **4 marks**. For each correct response, the candidate will get **4 marks**. For every wrong response **1 mark** shall be deducted from the total score. Unanswered / unattempted questions will be given no marks. The maximum marks are **720**.
3. Use **Blue / Black Ball point Pen only** for writing particulars on this page/markings responses.
4. Rough work is to be done in the space provided for this purpose in the Test Booklet only.
5. On completion of the test, the candidate must handover the Answer Sheet to the Invigilator before leaving the Room / Hall. *The candidates are allowed to take away this Test Booklet with them.*
6. The CODE for this Booklet is **M3**.
7. The candidates should ensure that the Answer Sheet is not folded. Do not make any stray marks on the Answer Sheet. Do not write your Roll No. anywhere else except in the specified space in the Test Booklet/Answer Sheet. Use of white fluid for correction is **NOT** permissible on the Answer Sheet.
8. Each candidate must show on demand his/her Admission Card to the Invigilator.
9. No candidate, without special permission of the Superintendent or Invigilator, would leave his/her seat.
10. Use of Electronic/Manual Calculator is prohibited.
11. The candidates are governed by all Rules and Regulations of the examination with regard to their conduct in the Examination Hall. All cases of unfair means will be dealt with as per Rules and Regulations of this examination.
12. No part of the Test Booklet and Answer Sheet shall be detached under any circumstances.
13. The candidates will write the Correct Test Booklet Code as given in the Test Booklet / Answer Sheet in the Attendance Sheet.

PHYSICS

SECTION - A

1. An infinitely long straight conductor carries a current of 5 A as shown. An electron is moving with a speed of 10^5 m/s parallel to the conductor. The perpendicular distance between the electron and the conductor is 20 cm at an instant. Calculate the magnitude of the force experienced by the electron at that instant.

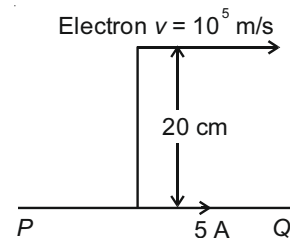

- (1) 4×10^{-20} N (2) $8\pi \times 10^{-20}$ N
(3) $4\pi \times 10^{-20}$ N (4) 8×10^{-20} N

Answer (4)

Sol. Magnetic field produced due to current carrying wire at point 'A'

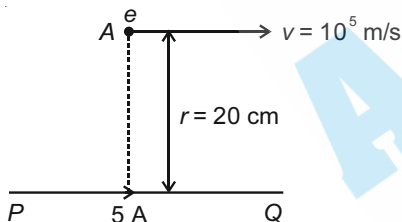

$$B = \frac{\mu_0 2I}{4\pi r}$$

$$B = \frac{10^{-7} \times 2 \times 5}{20 \times 10^{-2}} = \frac{1}{2} \times 10^{-5} \text{ (Tesla), upward to the plane of paper}$$

Now, force acting on electron due to this field

$$\vec{F} = q(\vec{v} \times \vec{B})$$

$$|\vec{F}| = 1.6 \times 10^{-19} \times 10^5 \times \frac{1}{2} \times 10^{-5}$$

$$= 0.8 \times 10^{-19} \text{ N}$$

$$|\vec{F}| = 8 \times 10^{-20} \text{ N}$$

2. A dipole is placed in an electric field as shown. In which direction will it move?

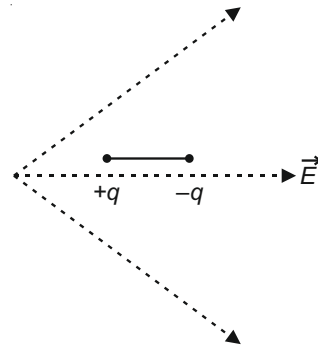

- (1) Towards the left as its potential energy will increase.
(2) Towards the right as its potential energy will decrease.
(3) Towards the left as its potential energy will decrease.
(4) Towards the right as its potential energy will increase.

Answer (2)

Sol. Potential energy of electric dipole in external electric field $U = -\vec{P} \cdot \vec{E}$

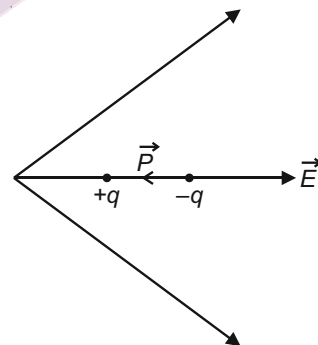

Angle between electric field and electric dipole is 180°

$$U = -PE \cos \theta$$

$$U = -PE \cos 180^\circ$$

$$U = +PE$$

On moving towards right electric field strength decrease therefore potential energy decrease.

Net force on electric dipole is towards right and net torque acting on it is zero.

So, it will move towards right.

3. An inductor of inductance L , a capacitor of capacitance C and a resistor of resistance ' R ' are connected in series to an ac source of potential difference ' V ' volts as shown in figure.

Potential difference across L , C and R is 40 V, 10 V and 40 V, respectively. The amplitude of current flowing through LCR series circuit is $10\sqrt{2}$ A. The impedance of the circuit is

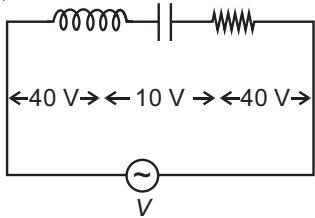

- (1) $4\sqrt{2} \Omega$ (2) $\frac{5}{\sqrt{2}} \Omega$
 (3) 4Ω (4) 5Ω

Answer (4)

Sol. $V_L = 40$ volt
 $V_R = 40$ volt
 $V_C = 10$ volt

$$\text{Now, } V_{RMS} = \sqrt{V_R^2 + (V_L - V_C)^2}$$

$$= \sqrt{(40)^2 + (40 - 10)^2} = 50 \text{ V}$$

$$I_{RMS} = \frac{I_0}{\sqrt{2}} = \frac{10\sqrt{2}}{\sqrt{2}} = 10 \text{ A}$$

$$\therefore V_{RMS} = I_{RMS} \times Z$$

$$\therefore Z = \frac{V_{RMS}}{I_{RMS}} = \frac{50}{10} = 5 \Omega$$

4. For a plane electromagnetic wave propagating in x-direction, which one of the following combination gives the correct possible directions for electric field (E) and magnetic field (B) respectively?

- (1) $\hat{j} + \hat{k}, \hat{j} + \hat{k}$ (2) $-\hat{j} + \hat{k}, -\hat{j} - \hat{k}$
 (3) $\hat{j} + \hat{k}, -\hat{j} - \hat{k}$ (4) $-\hat{j} + \hat{k}, -\hat{j} + \hat{k}$

Answer (2)

Sol. Direction of propagation of electromagnetic waves is along $\vec{E} \times \vec{B}$

Given that direction of propagation is along x-axis

- (1) $(\hat{j} + \hat{k}) \times (\hat{j} + \hat{k}) = 0$
 (2) $(-\hat{j} + \hat{k}) \times (-\hat{j} - \hat{k}) = 2\hat{i}$
 (3) $(\hat{j} + \hat{k}) \times [-(\hat{j} + \hat{k})] = 0$
 (4) $(-\hat{j} + \hat{k}) \times (-\hat{j} + \hat{k}) = 0$

\therefore Option (2) is correct.

5. A lens of large focal length and large aperture is best suited as an objective of an astronomical telescope since

- (1) A large aperture contributes to the quality and visibility of the images.
 (2) A large area of the objective ensures better light gathering power.
 (3) A large aperture provides a better resolution.
 (4) All of the above

Answer (4)

Sol. With larger aperture of objective lens, the light gathering power in telescope is high.

Also, the resolving power or the ability to observe two objects distinctly also depends on the diameter of the objective. Thus objective of large diameter is preferred.

Also, with large diameters fainter objects can be observed. Hence it also contributes to the better quality and visibility of images.

Hence, all options are correct.

6. **Column-I** gives certain physical terms associated with flow of current through a metallic conductor.

Column-II gives some mathematical relations involving electrical quantities. Match **Column-I** and **Column-II** with appropriate relations.

Column-I	Column-II
(A) Drift Velocity	(P) $\frac{m}{ne^2\rho}$
(B) Electrical Resistivity	(Q) nev_d
(C) Relaxation Period	(R) $\frac{eE}{m} \tau$
(D) Current Density	(S) $\frac{E}{J}$

- (1) (A) - (R), (B) - (S), (C) - (P), (D) - (Q)
 (2) (A) - (R), (B) - (S), (C) - (Q), (D) - (P)
 (3) (A) - (R), (B) - (P), (C) - (S), (D) - (Q)
 (4) (A) - (R), (B) - (Q), (C) - (S), (D) - (P)

Answer (1)

Sol. Drift velocity, $v_d = \frac{eE\tau}{m}$

Electrical resistivity, $\rho = \frac{1}{\sigma} = \frac{E}{J}$

Relaxation period, $\tau = \frac{m}{ne^2\rho}$

Current density, $J = \frac{I}{A} = nev_d$

(A) - (R), (B) - (S), (C) - (P), (D) - (Q)

7. An electromagnetic wave of wavelength ' λ ' is incident on a photosensitive surface of negligible work function. If ' m ' mass is of photoelectron emitted from the surface has de-Broglie wavelength λ_d , then

(1) $\lambda = \left(\frac{2m}{hc}\right)\lambda_d^2$ (2) $\lambda_d = \left(\frac{2mc}{h}\right)\lambda^2$

(3) $\lambda = \left(\frac{2mc}{h}\right)\lambda_d^2$ (4) $\lambda = \left(\frac{2h}{mc}\right)\lambda_d^2$

Answer (3)

Sol. As per Einstein's photoelectric equation

$$\frac{hc}{\lambda} = \phi_0 + k$$

ϕ_0 : work function

k = maximum kinetic energy of photoelectrons

As per question, $\phi \rightarrow 0$

$$\therefore \frac{hc}{\lambda} = k = \frac{P^2}{2m} \Rightarrow P = \sqrt{\frac{2mhc}{\lambda}}$$

Now De-broglie wavelength,

$$\lambda_d = \frac{h}{P} = \frac{h}{\sqrt{2mhc/\lambda}}$$

$$\Rightarrow \sqrt{\lambda} = \lambda_d \sqrt{\frac{2mc}{h}}$$

$$\Rightarrow \lambda = \left(\frac{2mc}{h}\right)\lambda_d^2$$

8. A particle is released from height S from the surface of the Earth. At a certain height its kinetic energy is three times its potential energy. The height from the surface of earth and the speed of the particle at that instant are respectively

- (1) $\frac{S}{4}, \frac{3gS}{2}$ (2) $\frac{S}{4}, \frac{\sqrt{3gS}}{2}$
 (3) $\frac{S}{2}, \frac{\sqrt{3gS}}{2}$ (4) $\frac{S}{4}, \sqrt{\frac{3gS}{2}}$

Answer (4)

Sol. Let required height of body is y .

When body from rest falls through height $(S - y)$
 Then under constant acceleration

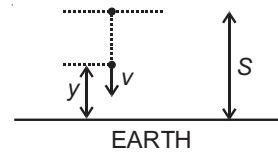

$$v^2 = 0^2 + 2g(S - y)$$

$$v = \sqrt{2g(S - y)} \quad \dots(1)$$

When body is at height y above ground. Potential energy of body of mass m

$$U = mgy$$

As per given condition kinetic energy, $K = 3U$

$$\frac{1}{2}m(v)^2 = 3 \times mg(y)$$

$$\frac{1}{2} \times m \times 2g(S - y) = 3 \times mgy \quad \text{(using (1))}$$

$$S - y = 3y$$

$$\therefore y = \frac{S}{4} \quad \dots(2)$$

$$\therefore v = \sqrt{2 \times g \left(S - \frac{S}{4}\right)} = \sqrt{\frac{3gS}{2}} \quad \dots(3)$$

9. A screw gauge gives the following readings when used to measure the diameter of a wire

Main scale reading : 0 mm

Circular scale reading : 52 divisions

Given that 1 mm on main scale corresponds to 100 divisions on the circular scale. The diameter of the wire from the above data is

- (1) 0.52 cm (2) 0.026 cm
 (3) 0.26 cm (4) 0.052 cm

Answer (4)

Sol. Here, pitch of the screw gauge, $P = 1$ mm

Number of circular division, $n = 100$

$$\text{Thus least count } LC = \frac{P}{n} = \frac{1}{100} = 0.01 \text{ mm} \\ = 0.001 \text{ cm}$$

So, diameter of the wire = $MSR + (CSR \times LC)$
 $= 0 + (52 \times 0.001 \text{ cm})$
 $= 0.052 \text{ cm}$

10. A thick current carrying cable of radius 'R' carries current 'I' uniformly distributed across its cross-section. The variation of magnetic field $B(r)$ due to the cable with the distance 'r' from the axis of the cable is represented by

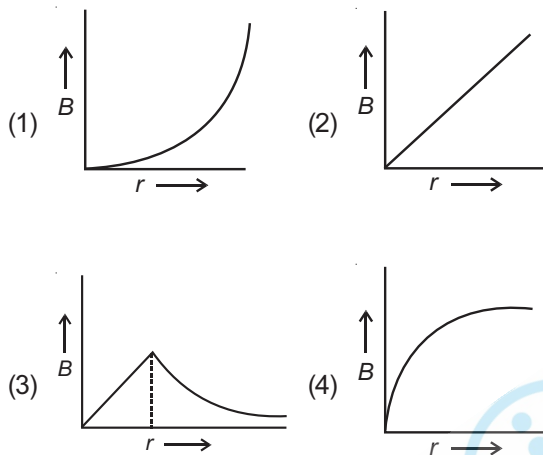

Answer (3)

Sol. From Ampere's circuital law

$$B = \frac{\mu_0 I}{2\pi R^2} \cdot r \quad \text{if } r < R \Rightarrow B_{\text{inside}} \propto r$$

$$B = \frac{\mu_0 I}{2\pi r} \quad \text{if } r \geq R \Rightarrow B_{\text{outside}} \propto \frac{1}{r}$$

Hence the correct plot of magnetic field B with distance r from axis of cable is given as

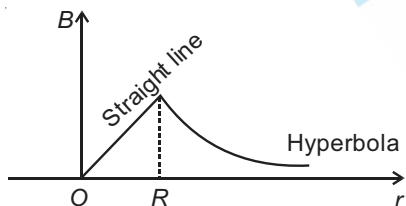

11. Two charged spherical conductors of radius R_1 and R_2 are connected by a wire. Then the ratio of surface charge densities of the spheres (σ_1/σ_2) is

(1) $\frac{R_1}{R_2}$ (2) $\frac{R_2}{R_1}$

(3) $\sqrt{\left(\frac{R_1}{R_2}\right)}$ (4) $\frac{R_1^2}{R_2^2}$

Answer (2)

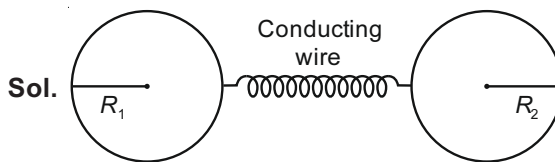

When two conductors are connected by a conducting wire, then the two conductors should have same potential.

so, $V_1 = V_2$

$$\therefore \frac{1}{4\pi\epsilon_0} \frac{Q_1}{R_1} = \frac{1}{4\pi\epsilon_0} \frac{Q_2}{R_2}$$

$$\Rightarrow \frac{1}{4\pi\epsilon_0} \frac{Q_1}{R_1} \times \frac{R_1}{R_1} = \frac{1}{4\pi\epsilon_0} \frac{Q_2}{R_2} \times \frac{R_2}{R_2}$$

$$\Rightarrow \frac{Q_1 R_1}{4\pi R_1^2 \epsilon_0} = \frac{Q_2 R_2}{4\pi R_2^2 \epsilon_0}$$

$$\Rightarrow \frac{\sigma_1 R_1}{\epsilon_0} = \frac{\sigma_2 R_2}{\epsilon_0}$$

$$\Rightarrow \frac{\sigma_1}{\sigma_2} = \frac{R_2}{R_1}$$

12. The number of photons per second on an average emitted by the source of monochromatic light of wavelength 600 nm, when it delivers the power of 3.3×10^{-3} watt will be ($h = 6.6 \times 10^{-34}$ J s)

- (1) 10^{18} (2) 10^{17}
 (3) 10^{16} (4) 10^{15}

Answer (3)

Sol. The power of a source is given as

$$P = \frac{E}{t} = \frac{n(hc)}{t(\lambda)}$$

$$\Rightarrow \frac{n}{t} = \frac{P}{\left(\frac{hc}{\lambda}\right)}$$

(Here $\frac{n}{t}$ is number of photons emitted per second)

$$\Rightarrow \frac{n}{t} = \frac{3.3 \times 10^{-3} \times 6 \times 10^{-7}}{6.6 \times 10^{-34} \times 3 \times 10^8}$$

$$= 10^{16} \text{ photons per second}$$

13. A cup of coffee cools from 90°C to 80°C in t minutes, when the room temperature is 20°C . The time taken by a similar cup of coffee to cool from 80°C to 60°C at a room temperature same at 20°C is

- (1) $\frac{13}{10}t$ (2) $\frac{13}{5}t$
(3) $\frac{10}{13}t$ (4) $\frac{5}{13}t$

Answer (2)

Sol. From Average form of Newton's law of cooling

$$-\left(\frac{T_1 + T_2}{2} - T_s\right)K = \frac{T_1 - T_2}{\Delta t}$$

T_1 and T_2 are initial and final temperature and T_s is surrounding temperature.

$$\Rightarrow -K\left[\frac{(90 + 80)}{2} - 20\right] = \frac{90 - 80}{t}$$

$$\Rightarrow -K(65) = \frac{10}{t}$$

$$\Rightarrow K = \frac{-2}{13t}$$

In second case,

$$-K\left(\frac{80 + 60}{2} - 20\right) = \frac{(80 - 60)}{t_1}$$

$$\Rightarrow -K(50) = \frac{20}{t_1}$$

$$\Rightarrow \frac{2}{13t}(50) = \frac{20}{t_1}$$

$$\Rightarrow t_1 = \frac{13t}{5}$$

14. The equivalent capacitance of the combination shown in the figure is

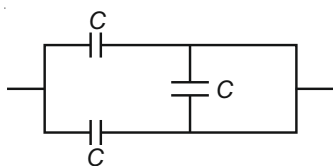

- (1) $3C$ (2) $2C$
(3) $\frac{C}{2}$ (4) $\frac{3C}{2}$

Answer (2)

Sol. Given circuit is

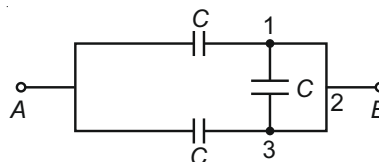

Points 1, 2, 3 are at same potential (as they are connected by conducting wire)

So the capacitor is short circuited. It does not store any charge.

The circuit can be redrawn as

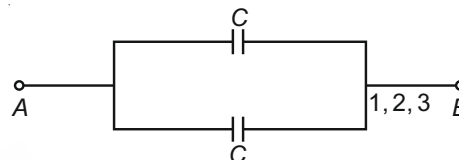

$$C_{AB} = C + C = 2C \text{ (Parallel combination)}$$

15. The effective resistance of a parallel connection that consists of four wires of equal length, equal area of cross-section and same material is 0.25Ω . What will be the effective resistance if they are connected in series?

- (1) 0.25Ω (2) 0.5Ω
(3) 1Ω (4) 4Ω

Answer (4)

Sol. All the wires are identical and of same material so they will have same value of resistance. Let it be R . When these are (four) connected in parallel.

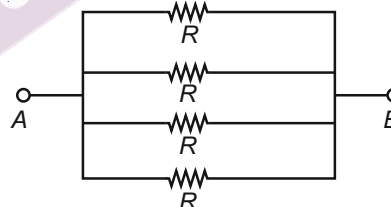

$$R_p = \frac{R}{4} \quad \left(\frac{1}{R_p} = \frac{1}{R_1} + \frac{1}{R_2} + \frac{1}{R_3} + \frac{1}{R_4} \right)$$

Given $R_p = 0.25 \Omega$

$$\therefore 0.25 = \frac{R}{4}$$

$$\therefore R = 1 \Omega$$

Now these four resistances are arranged in series

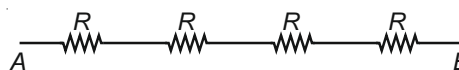

$$R_s = R + R + R + R = 4R$$

$$\therefore R_s = 4 \times 1 = 4 \Omega$$

16. Find the value of the angle of emergence from the prism. Refractive index of the glass is $\sqrt{3}$.

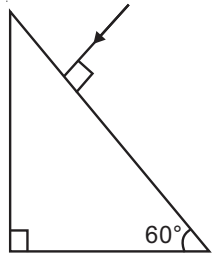

- (1) 60° (2) 30°
 (3) 45° (4) 90°

Answer (1)

Sol. From the ray diagram shown in the figure.
 At point P , from Snell's law

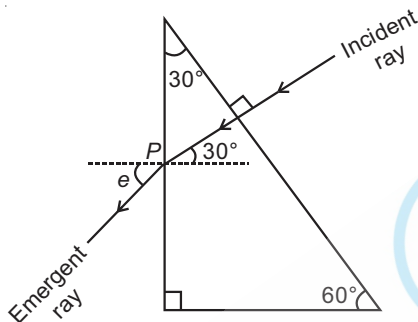

$$\frac{\sin i}{\sin r} = \frac{\mu_{\text{air}}}{\mu_{\text{Prism}}}$$

$$\Rightarrow \frac{\sin 30^\circ}{\sin e} = \frac{1}{\sqrt{3}} \quad (\angle r = \angle e \text{ emergent angle})$$

$$\Rightarrow \sin e = \sqrt{3} \cdot \frac{1}{2}$$

$$\Rightarrow \angle e = 60^\circ$$

17. A small block slides down on a smooth inclined plane, starting from rest at time $t = 0$. Let S_n be the distance travelled by the block in the interval

$t = n - 1$ to $t = n$. Then, the ratio $\frac{S_n}{S_{n+1}}$ is

- (1) $\frac{2n-1}{2n}$ (2) $\frac{2n-1}{2n+1}$
 (3) $\frac{2n+1}{2n-1}$ (4) $\frac{2n}{2n-1}$

Answer (2)

Sol. Suppose θ is inclination of inclined plane
 acceleration along inclined plane $a = g \sin \theta$
 S_n = distance travelled by object during n^{th} second.
 Initial speed $u = 0$

By equation of uniformly accelerated motion

$$S_n = u + \frac{a}{2}(2n - 1)$$

$$S_n = 0 + \frac{g \sin \theta}{2}(2n - 1) = \frac{g \sin \theta}{2}(2n - 1) \quad \dots(i)$$

Distance travelled during $(n + 1)^{\text{th}}$ second.

$$S_{n+1} = 0 + \frac{g \sin \theta}{2}[2(n + 1) - 1] = \frac{g \sin \theta}{2}(2n + 1) \quad \dots(ii)$$

Dividing equations (i) and (ii)

$$\frac{S_n}{S_{n+1}} = \frac{(2n - 1)}{(2n + 1)}$$

18. The escape velocity from the Earth's surface is v . The escape velocity from the surface of another planet having a radius, four times that of Earth and same mass density is

- (1) v (2) $2v$
 (3) $3v$ (4) $4v$

Answer (4)

Sol. Escape velocity from the Earth's surface

$$v_e = \sqrt{\frac{2GM}{R}}$$

$$= \sqrt{\frac{2G\rho \frac{4}{3}\pi R^3}{R}}$$

$$= \sqrt{\frac{8G\rho\pi}{3} R^2}$$

$v_e \propto R$ (For same density)

$$\frac{v}{v_1} = \frac{R}{4R}$$

$$v_1 = 4v$$

19. The half-life of a radioactive nuclide is 100 hours. The fraction of original activity that will remain after 150 hours would be

- (1) $\frac{1}{2}$ (2) $\frac{1}{2\sqrt{2}}$
 (3) $\frac{2}{3}$ (4) $\frac{2}{3\sqrt{2}}$

Answer (2)

Sol. The activity of a radioactive substance is given as

$$A = A_0 \left(\frac{1}{2}\right)^{\frac{t}{T_{1/2}}}$$

$$\text{Now, } \frac{A}{A_0} = \left(\frac{1}{2}\right)^{\frac{t}{T_{1/2}}}$$

$$\Rightarrow \frac{A}{A_0} = \left(\frac{1}{2}\right)^{\frac{150}{100}}$$

$$\Rightarrow \frac{A}{A_0} = \left(\frac{1}{2}\right)^{\frac{3}{2}}$$

$$\Rightarrow \frac{A}{A_0} = \frac{1}{2\sqrt{2}}$$

20. In a potentiometer circuit a cell of EMF 1.5 V gives balance point at 36 cm length of wire. If another cell of EMF 2.5 V replaces the first cell, then at what length of the wire, the balance point occurs?

- (1) 60 cm (2) 21.6 cm
(3) 64 cm (4) 62 cm

Answer (1)

Sol. From the application of potentiometer to compare two cells of emfs E_1 and E_2 by balancing lengths l_1 and l_2

$$\frac{E_1}{E_2} = \frac{l_1}{l_2}$$

$$\Rightarrow l_2 = l_1 \left(\frac{E_2}{E_1}\right) = (36 \text{ cm}) \left(\frac{2.5 \text{ V}}{1.5 \text{ V}}\right) = 60 \text{ cm}$$

21. Water falls from a height of 60 m at the rate of 15 kg/s to operate a turbine. The losses due to frictional force are 10% of the input energy. How much power is generated by the turbine?

$$(g = 10 \text{ m/s}^2)$$

- (1) 10.2 kW (2) 8.1 kW
(3) 12.3 kW (4) 7.0 kW

Answer (2)

Sol. Incident power on turbine = $\frac{d(mgh)}{dt}$

$$= gh \frac{dm}{dt}$$

$$= 10 \times 60 \times 15$$

$$= 9000 \text{ W}$$

Now, losses are 10%

$$\therefore \text{power generated} = \left(1 - \frac{10}{100}\right) \times 9000$$

$$= 8100 \text{ W} = 8.1 \text{ kW}$$

22. The electron concentration in an n -type semiconductor is the same as hole concentration in a p -type semiconductor. An external field (electric) is applied across each of them. Compare the currents in them.

- (1) Current in n -type = current in p -type
(2) Current in p -type > current in n -type
(3) Current in n -type > current in p -type
(4) No current will flow in p -type, current will only flow in n -type

Answer (3)

Sol. The current through a semiconductor is

$$I = neAv_d$$

$$I = neA\mu_e E$$

$$\frac{I_n}{I_p} = \frac{n_e e A \mu_e E}{n_h e A \mu_h E}$$

$$\frac{I_n}{I_p} = \frac{\mu_e}{\mu_h}$$

$$\therefore \mu_e > \mu_h$$

$$\Rightarrow I_n > I_p$$

23. Match **Column - I** and **Column - II** and choose the correct match from the given choices.

Column - I	Column - II
(A) Root mean square speed of gas molecules	(P) $\frac{1}{3} n m \bar{v}^2$
(B) Pressure exerted by ideal gas	(Q) $\sqrt{\frac{3RT}{M}}$
(C) Average kinetic energy of a molecule	(R) $\frac{5}{2} RT$
(D) Total internal energy of 1 mole of a diatomic gas	(S) $\frac{3}{2} k_B T$
(1) (A) - (R), (B) - (P), (C) - (S), (D) - (Q)	
(2) (A) - (Q), (B) - (R), (C) - (S), (D) - (P)	
(3) (A) - (Q), (B) - (P), (C) - (S), (D) - (R)	
(4) (A) - (R), (B) - (Q), (C) - (P), (D) - (S)	

Answer (3)

Sol. Root mean square speed of gas molecule

$$= \sqrt{\frac{3RT}{M}}$$

$$\text{Pressure exerted by ideal gas} = \frac{1}{3}nm\bar{v}^2$$

$$\text{Average kinetic energy of a molecule} = \frac{3}{2}k_B T$$

$$\text{Total internal energy of a gas is } (U) = \frac{1}{2}nfRT$$

Here, $n = 1$

$f = 5$

$$U = \frac{5}{2}RT$$

Hence, (A) - (Q), (B) - (P), (C) - (S), (D) - (R)

24. A spring is stretched by 5 cm by a force 10 N. The time period of the oscillations when a mass of 2 kg is suspended by it is

- (1) 0.0628 s (2) 6.28 s
 (3) 3.14 s (4) 0.628 s

Answer (4)

Sol. For a spring, $kx = F$

given $x = 5$ cm, $F = 10$ N

$$\Rightarrow k(5 \times 10^{-2}) = 10$$

$$\Rightarrow k = \frac{1000}{5} = 200 \text{ N/m}$$

Now, for spring-mass system undergoing SHM

$$T = 2\pi\sqrt{\frac{m}{k}}$$

given, $m = 2$ kg

$$\Rightarrow T = 2\pi\sqrt{\frac{2}{200}} = \frac{2\pi}{10} = 0.628 \text{ s}$$

25. The velocity of a small ball of mass M and density d , when dropped in a container filled with glycerine becomes constant after some time. If the density of

glycerine is $\frac{d}{2}$, then the viscous force acting on the ball will be

- (1) $\frac{Mg}{2}$ (2) Mg
 (3) $\frac{3}{2}Mg$ (4) $2Mg$

Answer (1)

Sol. Let F_v be the viscous force and F_B be the Bouyant force acting on the ball.

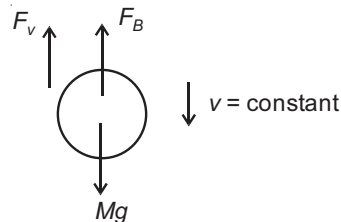

Then, when body moves with constant velocity

$$Mg = F_B + F_v \quad [a = 0]$$

$$F_v = Mg - F_B$$

$$= dVg - \frac{d}{2} \cdot Vg \quad (M = dVg) \quad V = \text{volume of ball.}$$

$$= \frac{d}{2}Vg$$

$$F_v = \frac{M}{2}g$$

26. A body is executing simple harmonic motion with frequency 'n', the frequency of its potential energy is

- (1) n
 (2) $2n$
 (3) $3n$
 (4) $4n$

Answer (2)

Sol. Equation of displacement of particle executing

SHM is given by $x = A\sin(\omega t + \phi)$... (I)

Potential energy of particle executing SHM is given by

$$U = \frac{1}{2}kx^2$$

$$= \frac{1}{2}kA^2 \sin^2(\omega t + \phi) \quad \dots \text{(II)}$$

From I and II, it is clear that

Time period of $x = A\sin(\omega t + \phi)$ is

$$T_1 = \frac{2\pi}{\omega} \Rightarrow \text{frequency } n_1 = \frac{\omega}{2\pi}$$

while time period of $x^2 = A^2 \sin^2(\omega t + \phi)$ is

$$T_2 = \frac{\pi}{\omega} \Rightarrow \text{frequency } n_2 = \frac{\omega}{\pi}$$

Hence $n_2 = 2n_1$

27. A nucleus with mass number 240 breaks into two fragments each of mass number 120, the binding energy per nucleon of unfragmented nuclei is 7.6 MeV while that of fragments is 8.5 MeV. The total gain in the Binding Energy in the process is

- (1) 0.9 MeV
- (2) 9.4 MeV
- (3) 804 MeV
- (4) 216 MeV

Answer (4)

Sol. Mass number of reactant = 240

BE per nucleon = 7.6 MeV

Mass number of products = 120

BE per nucleon of product = 8.5 MeV

Total gain in BE = (BE) of products – (BE) of reactants.

$$= [120 + 120] \times 8.5 - [240] \times 7.6$$

$$= (240) \times 8.5 - 240 \times 7.6$$

$$= (2040 - 1824) \text{ MeV}$$

Gain in BE = 216 MeV

28. A parallel plate capacitor has a uniform electric field ' \vec{E} ' in the space between the plates. If the distance between the plates is ' d ' and the area of each plate is ' A ', the energy stored in the capacitor is (ϵ_0 = permittivity of free space)

- (1) $\frac{1}{2} \epsilon_0 E^2$
- (2) $\epsilon_0 EAd$
- (3) $\frac{1}{2} \epsilon_0 E^2 Ad$
- (4) $\frac{E^2 Ad}{\epsilon_0}$

Answer (3)

Sol.

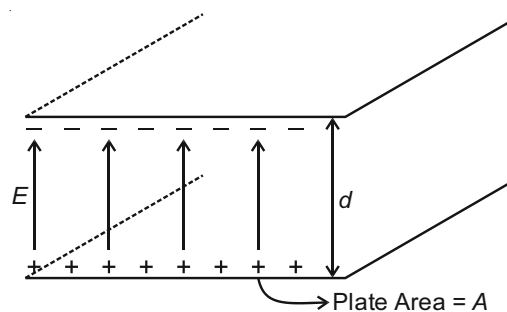

Energy density associated with electric field is given by

$$u = \frac{dU}{dV} = \frac{1}{2} \epsilon_0 E^2$$

$$\Rightarrow dU = \frac{1}{2} \epsilon_0 E^2 dV$$

Total energy stored in the space between the capacitor will be

$$U = \int dU = \int \frac{1}{2} \epsilon_0 E^2 dV$$

$$= \frac{1}{2} \epsilon_0 E^2 \int dV \quad [E \text{ is constant}]$$

$$= \frac{1}{2} \epsilon_0 E^2 V = \frac{1}{2} \epsilon_0 E^2 Ad \quad [V = Ad]$$

29. Polar molecules are the molecules

- (1) Having zero dipole moment
- (2) Acquire a dipole moment only in the presence of electric field due to displacement of charges
- (3) Acquire a dipole moment only when magnetic field is absent
- (4) Having a permanent electric dipole moment

Answer (4)

Sol. In polar molecules, the centre of positive charges does not coincide with the centre of negative charges.

Hence, these molecules have a permanent electric dipole moment of their own.

30. A radioactive nucleus ${}^A_Z X$ undergoes spontaneous decay in the sequence

${}^A_Z X \rightarrow {}_{Z-1} B \rightarrow {}_{Z-3} C \rightarrow {}_{Z-2} D$, where Z is the atomic number of element X. The possible decay particles in the sequence are

- (1) α, β^-, β^+
- (2) α, β^+, β^-
- (3) β^+, α, β^-
- (4) β^-, α, β^+

Answer (3)

Sol. On β^+ decay atomic number decreases by 1

On β^- decay atomic number increases by 1

On α decay atomic number decreases by 2

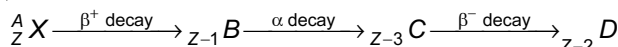

Hence correct order of decay are β^+, α, β^-

31. Consider the following **statements (A) and (B)** and identify the **correct** answer.
- (A) A zener diode is connected in reverse bias, when used as a voltage regulator.
- (B) The potential barrier of *p-n* junction lies between 0.1 V to 0.3 V.
- (1) (A) and (B) both are correct.
 - (2) (A) and (B) both are incorrect
 - (3) (A) is correct and (B) is incorrect.
 - (4) (A) is incorrect but (B) is correct.

Answer (3)

Sol. • In reverse biased, after breakdown, voltage across the zener diode becomes constant. Therefore zener diode is connected in reverse biased when used as voltage regulator.

- Potential barrier of silicon diode is nearly 0.7 V statement A is correct and statement B is incorrect.

32. A capacitor of capacitance 'C', is connected across an ac source of voltage V, given by
- $$V = V_0 \sin \omega t$$
- The displacement current between the plates of the capacitor, would then be given by
- (1) $I_d = V_0 \omega C \cos \omega t$
 - (2) $I_d = \frac{V_0}{\omega C} \cos \omega t$
 - (3) $I_d = \frac{V_0}{\omega C} \sin \omega t$
 - (4) $I_d = V_0 \omega C \sin \omega t$

Answer (1)

Sol. Given $V = V_0 \sin \omega t$... (1)
Now displacement current I_d is given by

$$I_d = C \frac{dV}{dt}$$

$$= C \frac{d}{dt} (V_0 \sin \omega t) \quad \text{(using equation 1)}$$

$$= C (V_0 \omega) \cos \omega t$$

$$I_d = V_0 \omega C \cos \omega t$$

33. If *E* and *G* respectively denote energy and gravitational constant, then $\frac{E}{G}$ has the dimensions of

- (1) $[M^2] [L^{-1}] [T^0]$
- (2) $[M] [L^{-1}] [T^{-1}]$
- (3) $[M] [L^0] [T^0]$
- (4) $[M^2] [L^{-2}] [T^{-1}]$

Answer (1)

Sol. Dimensional formula of energy

$$[E] = [M^1 L^2 T^{-2}] \quad \dots \text{(I)}$$

Dimensional formula of gravitational constant

$$[G] = [M^{-1} L^3 T^{-2}] \quad \dots \text{(II)}$$

From (I) & (II)

$$\frac{[E]}{[G]} = \frac{[M^1 L^2 T^{-2}]}{[M^{-1} L^3 T^{-2}]}$$

$$= [M^2 L^{-1} T^0]$$

Hence, dimensions of $\left[\frac{E}{G}\right] = [M^2 L^{-1} T^0]$

So, correct option is (1)

34. A convex lens 'A' of focal length 20 cm and a concave lens 'B' of focal length 5 cm are kept along the same axis with a distance 'd' between them. If a parallel beam of light falling on 'A' leaves 'B' as a parallel beam, then the distance 'd' in cm will be
- (1) 25
 - (2) 15
 - (3) 50
 - (4) 30

Answer (2)

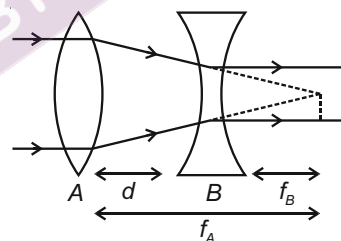

Sol.

Parallel beam of light after refraction from convex lens converge at the focus of convex lens. In question it is given light after refraction pass through concave lens becomes parallel. Therefore light refracted from convex lens virtually meet at focus of concave lens. According to above ray diagram $d = f_A - f_B = 20 - 5 = 15$ cm

35. If force [F], acceleration [A] and time [T] are chosen as the fundamental physical quantities. Find the dimensions of energy.
- (1) $[F][A][T]$
 - (2) $[F][A][T^2]$
 - (3) $[F][A][T^{-1}]$
 - (4) $[F][A^{-1}][T]$

Answer (2)

Sol. Energy, $E \propto F^a A^b T^c$

$$[E] = [F^a][A^b][T^c]$$

$$\Rightarrow [ML^2T^{-2}] = [MLT^{-2}]^a [LT^{-2}]^b [T]^c$$

$$[ML^2T^{-2}] = [M^a L^{a+b} T^{-2a-2b+c}]$$

Comparing dimensions on both sides.

$$\Rightarrow a = 1; a + b = 2 \text{ and } -2 = -2a - 2b + c$$

$$\Rightarrow b = 1 \quad \Rightarrow -2 = -2 - 2 + c$$

$$\Rightarrow c = 2$$

$$[E] = [FAT^2]$$

SECTION - B

36. A step down transformer connected to an ac mains supply of 220 V is made to operate at 11 V, 44 W lamp. Ignoring power losses in the transformer, what is the current in the primary circuit?

- (1) 0.2 A (2) 0.4 A
(3) 2 A (4) 4 A

Answer (1)

Sol. In ideal transformer:

Input power = Output power

$$\Rightarrow V_p I_p = V_s I_s = \text{Given power}$$

$$\Rightarrow 220 \times I_p = 44$$

$$\Rightarrow I_p = 0.2 \text{ A}$$

37. A ball of mass 0.15 kg is dropped from a height 10 m, strikes the ground and rebounds to the same height. The magnitude of impulse imparted to the ball is ($g = 10 \text{ m/s}^2$) nearly

- (1) 0 kg m/s (2) 4.2 kg m/s
(3) 2.1 kg m/s (4) 1.4 kg m/s

Answer (2)

Sol. Given that :

Mass of ball = 0.15 kg

Height from which ball is dropped = 10 m

Impulse, \vec{I} = Change in linear momentum = $\Delta \vec{P}$

$$= \vec{P}_f - \vec{P}_i$$

Velocity of ball at ground (v) = $\sqrt{2gh}$

$$= \sqrt{2 \times 10 \times 10} = 10\sqrt{2} \text{ m/s}$$

$$\vec{I} = 0.15 \times 10\sqrt{2}(-\hat{j}) - 0.15 \times 10\sqrt{2}(\hat{j})$$

$$\vec{I} = 2 \times 0.15 \times 10\sqrt{2}(-\hat{j}) = 4.2(-\hat{j})$$

\Rightarrow magnitude of impulse = 4.2 kg m/s

38. A particle moving in a circle of radius R with a uniform speed takes a time T to complete one revolution. If this particle were projected with the same speed at an angle ' θ ' to the horizontal, the maximum height attained by it equals $4R$. The angle of projection, θ , is then given by :

$$(1) \theta = \cos^{-1} \left(\frac{gT^2}{\pi^2 R} \right)^{1/2}$$

$$(2) \theta = \cos^{-1} \left(\frac{\pi^2 R}{gT^2} \right)^{1/2}$$

$$(3) \theta = \sin^{-1} \left(\frac{\pi^2 R}{gT^2} \right)^{1/2}$$

$$(4) \theta = \sin^{-1} \left(\frac{2gT^2}{\pi^2 R} \right)^{1/2}$$

Answer (4)

Sol. To complete a circular path of radius R , time period is T .

$$\text{So speed of particle } (U) = \frac{2\pi R}{T} \dots\dots(1)$$

Now the particle is projected with same speed at angle θ to horizontal.

$$\text{So Maximum Height } (H) = \frac{U^2 \sin^2 \theta}{2g}$$

Given that : $H = 4R$

$$\Rightarrow \frac{U^2 \sin^2 \theta}{2g} = 4R$$

$$\Rightarrow \sin^2 \theta = \frac{8gR}{U^2} \dots\dots(2)$$

$$\Rightarrow \sin^2 \theta = \frac{8gRT^2}{4\pi^2 R^2} = \frac{2gT^2}{\pi^2 R} \text{ (using equation 1)}$$

$$\Rightarrow \theta = \sin^{-1} \left(\frac{2gT^2}{\pi^2 R} \right)^{1/2}$$

39. A particle of mass ' m ' is projected with a velocity $v = kV_e$ ($k < 1$) from the surface of the earth.
(V_e = escape velocity)

The maximum height above the surface reached by the particle is

(1) $R \left(\frac{k}{1-k} \right)^2$

(2) $R \left(\frac{k}{1+k} \right)^2$

(3) $\frac{R^2 k}{1+k}$

(4) $\frac{Rk^2}{1-k^2}$

Answer (4)

Sol. given $v = kV_e$

where, $k < 1$

Thus, $v < V_e$

From conservation of mechanical energy,

$$\frac{1}{2}mv^2 - \frac{GmM}{R} = -\frac{GmM}{(R+h)}$$

$$\Rightarrow \frac{v^2}{2} = \frac{GM}{R} - \frac{(GM)}{(R+h)} = \frac{h}{R(R+h)} GM$$

$$\Rightarrow \frac{1}{2}k^2V_e^2 = \frac{GMh}{R(R+h)}$$

We know, $V_e = \sqrt{\frac{2GM}{R}}$

$$\Rightarrow \frac{1}{2}k^2 \left(\frac{2GM}{R} \right) = \frac{GMh}{R(R+h)}$$

$$k^2 = \frac{h}{(R+h)}$$

$$Rk^2 + hk^2 = h$$

$$Rk^2 = h(1 - k^2)$$

$$\therefore h = \frac{Rk^2}{(1-k^2)}$$

40. A car starts from rest and accelerates at 5 m/s^2 . At $t = 4 \text{ s}$, a ball is dropped out of a window by a person sitting in the car. What is the velocity and acceleration of the ball at $t = 6 \text{ s}$?

(Take $g = 10 \text{ m/s}^2$)

(1) 20 m/s , 5 m/s^2

(2) 20 m/s , 0

(3) $20\sqrt{2} \text{ m/s}$, 0

(4) $20\sqrt{2} \text{ m/s}$, 10 m/s^2

Answer (4)

Sol. Initial velocity of car = 0

Acceleration of car = 5 m/s^2

Velocity of car at $t = 4 \text{ s}$; $v = u + at$

$$\Rightarrow v = 0 + 5 \times 4 = 20 \text{ ms}^{-1}$$

At $t = 4 \text{ s}$, A ball is dropped out of a window so velocity of ball at this instant is 20 ms^{-1} along horizontal.

After 2 seconds of motion :

Horizontal velocity of ball = 20 ms^{-1} ($\because a_x = 0$)

Vertical velocity of ball (v_y) = $u_y + a_y t$

$$v_y = 0 + 10 \times 2 = 20 \text{ ms}^{-1} \quad (\because a_y = g = 10 \text{ m/s}^2)$$

So magnitude of velocity of ball

$$(v) = \sqrt{v_x^2 + v_y^2} = 20\sqrt{2} \text{ m/s}$$

Acceleration of ball at $t = 6 \text{ s}$ is $g = 10 \text{ m/s}^2$

As ball is under free fall.

41. A point object is placed at a distance of 60 cm from a convex lens of focal length 30 cm . If a plane mirror were put perpendicular to the principal axis of the lens and at a distance of 40 cm from it, the final image would be formed at a distance of

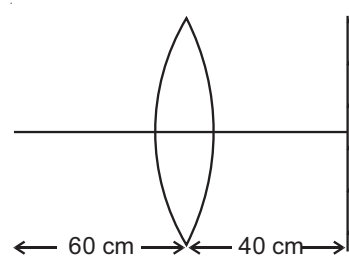

- (1) 20 cm from the lens, it would be a real image
 (2) 30 cm from the lens, it would be a real image
 (3) 30 cm from the plane mirror, it would be a virtual image
 (4) 20 cm from the plane mirror, it would be a virtual image

Answer (4)

Sol. Using lens formula for first refraction from convex lens

$$\frac{1}{v_1} - \frac{1}{u} = \frac{1}{f}$$

$$v_1 = ?, u = -60 \text{ cm}, f = 30 \text{ cm}$$

$$\Rightarrow \frac{1}{v_1} + \frac{1}{60} = \frac{1}{30} \Rightarrow v_1 = 60 \text{ cm}$$

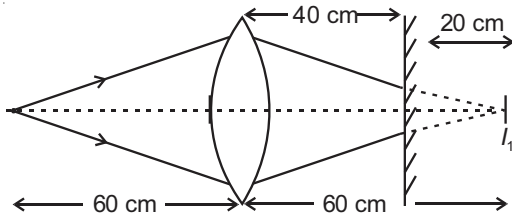

I_1 here is first image by lens

The plane mirror will produce an image at distance 20 cm to left of it.

For second refraction from convex lens,

$$u = -20 \text{ cm}, v = ?, f = 30 \text{ cm}$$

$$\frac{1}{v} - \frac{1}{u} = \frac{1}{f} \Rightarrow \frac{1}{v} + \frac{1}{20} = \frac{1}{30}$$

$$\Rightarrow \frac{1}{v} = \frac{1}{30} - \frac{1}{20} \Rightarrow v = -60 \text{ cm}$$

Thus the final image is virtual and at a distance, $60 - 40 = 20 \text{ cm}$ from plane mirror.

42. Twenty seven drops of same size are charged at 200 V each. They combine to form a bigger drop. Calculate the potential of the bigger drop.

- (1) 660 V (2) 1320 V
(3) 1520 V (4) 1980 V

Answer (4)

Sol. Electric potential due to a charged sphere = $\frac{kQ}{R}$

$$k = 9 \times 10^9 \text{ N-m}^2/\text{C}^2$$

Q : charge on sphere

R : Radius of sphere

Let charge and radius of smaller drop is q and r respectively

$$\text{For smaller drop, } V = \frac{kq}{r} = 220 \text{ V}$$

Let R be radius of bigger drop,

As volume remains the same

$$\left(\frac{4}{3}\pi r^3\right) \times 27 = \frac{4}{3}\pi R^3$$

$$\Rightarrow R = \sqrt[3]{27} r = 3r$$

Now, using charge conservation,

$$\Rightarrow Q = 27q$$

$$V_{\text{big drop}} = \frac{kQ}{R} = \frac{k(27q)}{3r} = 9\left(\frac{kq}{r}\right)$$

$$= 9 \times 220 = 1980 \text{ V}$$

43. In the product

$$\vec{F} = q(\vec{v} \times \vec{B})$$

$$= q\vec{v} \times (B\hat{i} + B\hat{j} + B_0\hat{k})$$

For $q = 1$ and $\vec{v} = 2\hat{i} + 4\hat{j} + 6\hat{k}$ and

$$\vec{F} = 4\hat{i} - 20\hat{j} + 12\hat{k}$$

What will be the complete expression for \vec{B} ?

- (1) $-8\hat{i} - 8\hat{j} - 6\hat{k}$
(2) $-6\hat{i} - 6\hat{j} - 8\hat{k}$
(3) $8\hat{i} + 8\hat{j} - 6\hat{k}$
(4) $6\hat{i} + 6\hat{j} - 8\hat{k}$

Answer (2)

Sol. $\vec{F} = q(\vec{v} \times \vec{B})$

$$= q\vec{v} \times (B\hat{i} + B\hat{j} + B_0\hat{k})$$

Given, $q = 1$ $\vec{v} = 2\hat{i} + 4\hat{j} + 6\hat{k}$ and

$$\vec{F} = 4\hat{i} - 20\hat{j} + 12\hat{k}$$

$$\Rightarrow (4\hat{i} - 20\hat{j} + 12\hat{k}) = -1 \times [(2\hat{i} + 4\hat{j} + 6\hat{k}) \times (B\hat{i} + B\hat{j} + B_0\hat{k})]$$

Thus, calculating values of RHS,

$$\begin{vmatrix} \hat{i} & \hat{j} & \hat{k} \\ 2 & 4 & 6 \\ B & B & B_0 \end{vmatrix}$$

$$\Rightarrow i(4B_0 - 6B) - j(2B_0 - 6B) + k(2B - 4B)$$

Comparing L.H.S and R.H.S,

$$4B_0 - 6B = 4 \Rightarrow 2B_0 - 3B = 2 \quad \dots(1)$$

$$-(2B_0 - 6B) = -20 \Rightarrow B_0 - 3B = 10 \quad \dots(2)$$

$$2B - 4B = 12 \Rightarrow B = -6 \quad \dots(3)$$

From (2) and (3)

$$B = -6 \text{ and } B_0 = -8$$

$$\text{Hence, } \vec{B} = -6\hat{i} - 6\hat{j} - 8\hat{k}$$

44. For the given circuit, the input digital signals are applied at the terminals A, B and C. What would be the output at the terminal y?

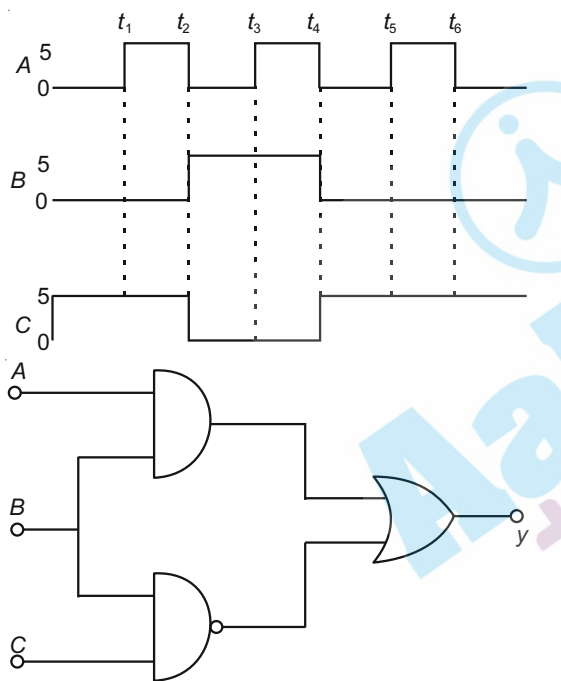

- (1)
- (2)
- (3)
- (4)

Answer (3)

Sol. Output of combination of logic gates is given as

$$y = A \cdot B + \overline{B} \cdot C$$

Time duration	Input Signals					Output Signal
	A	B	C	AB	$\overline{B} \cdot C$	$y = A \cdot B + \overline{B} \cdot C$
0 - t ₁	0	0	1	0	1	1
t ₁ - t ₂	1	0	1	0	1	1
t ₂ - t ₃	0	1	0	0	1	1
t ₃ - t ₄	1	1	0	1	1	1
t ₄ - t ₅	0	0	1	0	1	1
t ₅ - t ₆	1	0	1	0	1	1
t ₆ - t ₇	0	0	1	0	1	1

So the output y is high (1) that is v₀ = 5 V

45. A uniform rod of length 200 cm and mass 500 g is balanced on a wedge placed at 40 cm mark. A mass of 2 kg is suspended from the rod at 20 cm and another unknown mass 'm' is suspended from the rod at 160 cm mark as shown in the figure. Find the value of 'm' such that the rod is in equilibrium. (g = 10 m/s²)

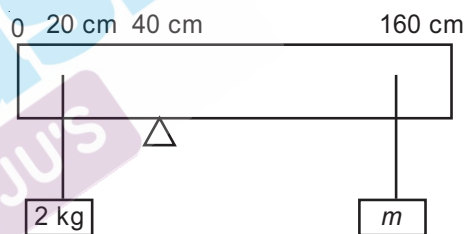

- (1) $\frac{1}{2}$ kg (2) $\frac{1}{3}$ kg
- (3) $\frac{1}{6}$ kg (4) $\frac{1}{12}$ kg

Answer (4)

Sol. Given that

Mass of rod = 500 g; Length of rod = 200 cm

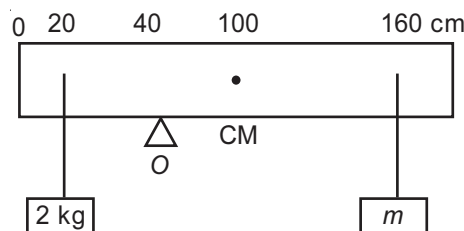

Rod will be in equilibrium, when net torque about point O will be zero.

Torque at point O due to 2 kg mass

$$\vec{\tau} = \vec{r} \times \vec{F} = rF \sin\theta(\hat{n})$$

$$\tau_1 = 20 \times 20 \times 10^{-2} \times \sin 90^\circ (\hat{k}) = 4 \text{ N m}(\hat{k})$$

Torque due to mass of rod :

$$\tau_2 = 5 \times 60 \times 10^{-2} \times \sin 90^\circ (-\hat{k}) = 3 \text{ N m}(-\hat{k})$$

Torque due to mass m

$$\tau_3 = mg \times 120 \times 10^{-2} \times \sin 90^\circ (-\hat{k}) = 12m \text{ N m}(-\hat{k})$$

Net torque about point O will be zero

$$\text{So } \vec{\tau}_1 + \vec{\tau}_2 + \vec{\tau}_3 = 0$$

$$\Rightarrow 4 - 3 - 12m = 0$$

$$\Rightarrow 12m = 1$$

$$m = \frac{1}{12} \text{ kg}$$

46. A uniform conducting wire of length $12a$ and resistance ' R ' is wound up as a current carrying coil in the shape of,

- an equilateral triangle of side ' a '.
- a square of side ' a '.

The magnetic dipole moments of the coil in each case respectively are

- $\sqrt{3} la^2$ and $3 la^2$
- $3 la^2$ and la^2
- $3 la^2$ and $4 la^2$
- $4 la^2$ and $3 la^2$

Answer (1)

Sol. Current in the loop will be $\frac{V}{R} = I$ which is same for

both loops.

Now magnetic moment of Triangle loop = NIA

$$M_1 = \left(\frac{12a}{3a}\right) \cdot I \cdot \frac{\sqrt{3}}{4} a^2 = \sqrt{3} la^2$$

and magnetic moment of square loop = $N'IA'$

$$= \left(\frac{12a}{4a}\right) \cdot I \cdot a^2$$

$$M_2 = 3la^2$$

47. Two conducting circular loops of radii R_1 and R_2 are placed in the same plane with their centres coinciding. If $R_1 \gg R_2$, the mutual inductance M between them will be directly proportional to

$$(1) \frac{R_1}{R_2}$$

$$(2) \frac{R_2}{R_1}$$

$$(3) \frac{R_1^2}{R_2}$$

$$(4) \frac{R_2^2}{R_1}$$

Answer (4)

Sol. Two concentric coils are of radius R_1 and R_2 as shown

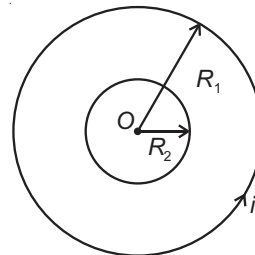

Let current in outer loop be i

$$\text{Magnetic field at centre} = B = \frac{\mu_0 i}{2R_1}$$

$$\text{Magnetic flux through inner coil} = B \times \pi R_2^2$$

$$\phi = \frac{\mu_0 i}{2R_1} \times \pi R_2^2$$

$$\phi = \frac{\mu_0 i}{2} \times \frac{\pi R_2^2}{R_1}$$

as per definition, $\phi = Mi$

$$\Rightarrow M = \left(\frac{\mu_0 \pi}{2}\right) \frac{R_2^2}{R_1}$$

$$\therefore M \propto \frac{R_2^2}{R_1}$$

48. From a circular ring of mass ' M ' and radius ' R ' an arc corresponding to a 90° sector is removed. The moment of inertia of the remaining part of the ring about an axis passing through the centre of the ring and perpendicular to the plane of the ring is ' K ' times ' MR^2 '. Then the value of ' K ' is

$$(1) \frac{3}{4}$$

$$(2) \frac{7}{8}$$

$$(3) \frac{1}{4}$$

$$(4) \frac{1}{8}$$

Answer (1)

Sol. Given that,

Mass of Ring = M ; Radius of Ring = R

Now 90° arc is removed from circular ring, then

$$\text{mass removed} = \frac{M}{4}$$

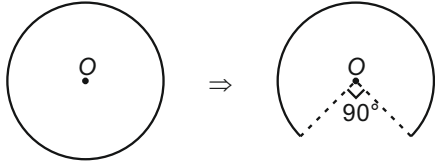

$$\text{Mass of remaining portion} = \frac{3M}{4}$$

$$\text{Moment of inertia of remaining part} = \int dm r^2$$

$$\Rightarrow I = R^2 \int dm \quad (\because r = R)$$

$$\Rightarrow I = \frac{3MR^2}{4}. \text{ So the value of } K \text{ is } \frac{3}{4}$$

49. Three resistors having resistances r_1 , r_2 and r_3 are connected as shown in the given circuit. The ratio

$\frac{i_3}{i_1}$ of currents in terms of resistances used in the

circuit is

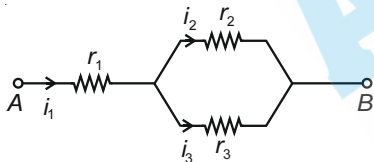

(1) $\frac{r_1}{r_2 + r_3}$

(2) $\frac{r_2}{r_2 + r_3}$

(3) $\frac{r_1}{r_1 + r_2}$

(4) $\frac{r_2}{r_1 + r_3}$

Answer (2)

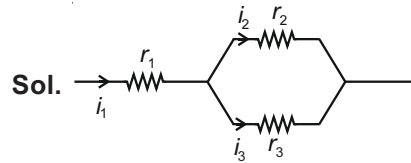

Sol.

In parallel combination of resistances r_2 and r_3 , potential difference will be equal across both resistance.

$$\text{So, } i_2 r_2 = i_3 r_3 \Rightarrow i_2 = \frac{i_3 r_3}{r_2} \quad \dots(1)$$

As per Kirchhoff's first law

$$\Rightarrow i_1 = i_2 + i_3$$

$$\Rightarrow i_1 = \left(\frac{r_3}{r_2} + 1 \right) i_3 \quad (\text{from equation 1})$$

$$\Rightarrow \frac{i_3}{i_1} = \frac{r_2}{r_2 + r_3}$$

50. A series LCR circuit containing 5.0 H inductor, 80 μF capacitor and 40 Ω resistor is connected to 230 V variable frequency ac source. The angular frequencies of the source at which power transferred to the circuit is half the power at the resonant angular frequency are likely to be

- (1) 25 rad/s and 75 rad/s
- (2) 50 rad/s and 25 rad/s
- (3) 46 rad/s and 54 rad/s
- (4) 42 rad/s and 58 rad/s

Answer (3)

Sol. The resonance frequency of LCR series circuit is

$$\text{given as } \omega_0 = \frac{1}{\sqrt{LC}} = \frac{1}{\sqrt{5 \times 80 \times 10^{-6}}} = 50 \text{ rad/s}$$

Now half power frequencies are given as

$$\omega = \omega_0 \pm \frac{R}{2L}$$

$$\text{i.e. } \omega_L = 50 - \frac{40}{2 \times 5} = 46 \text{ rad/s}$$

$$\omega_H = 50 + \frac{40}{2 \times 5} = 54 \text{ rad/s}$$

CHEMISTRY

SECTION - A

51. Noble gases are named because of their inertness towards reactivity. Identify an incorrect statement about them.

- (1) Noble gases are sparingly soluble in water
- (2) Noble gases have very high melting and boiling points
- (3) Noble gases have weak dispersion forces
- (4) Noble gases have large positive values of electron gain enthalpy

Answer (2)

Sol. Noble gases have weak dispersion forces hence they have low melting and boiling points.

52. The correct option for the number of body centred unit cells in all 14 types of Bravais lattice unit cells is :

- | | |
|-------|-------|
| (1) 7 | (2) 5 |
| (3) 2 | (4) 3 |

Answer (4)

Sol. • In 14 types of Bravais lattices, body centred unit cell is present in cubic, tetragonal and orthorhombic crystal systems.

- Hence, body centred possible variation is present in three crystal systems.

53. Which one among the following is the correct option for right relationship between C_p and C_v for one mole of ideal gas?

- (1) $C_p + C_v = R$
- (2) $C_p - C_v = R$
- (3) $C_p = RC_v$
- (4) $C_v = RC_p$

Answer (2)

Sol. At constant volume, $q_v = C_v \Delta T = \Delta U$

At constant pressure, $q_p = C_p \Delta T = \Delta H$

For a mole of an ideal gas,

$$\Delta H = \Delta U + \Delta(PV)$$

$$= \Delta U + \Delta(RT)$$

$$= \Delta U + R\Delta T$$

On putting the values of ΔH and ΔU , we have

$$C_p \Delta T = C_v \Delta T + R\Delta T$$

$$C_p = C_v + R$$

$$C_p - C_v = R$$

54. Zr ($Z = 40$) and Hf ($Z = 72$) have similar atomic and ionic radii because of :

- (1) Belonging to same group
- (2) Diagonal relationship
- (3) Lanthanoid contraction
- (4) Having similar chemical properties

Answer (3)

Sol. • The cumulative effect of the contraction of the lanthanoid series, known as lanthanoid contraction, causes the radii of the members of the third transition series to be very similar to those of the corresponding members of the second series.

- The almost identical radii of Zr (160 pm) and Hf (159 pm) is a consequence of the lanthanoid contraction.

55. The maximum temperature that can be achieved in blast furnace is :

- | | |
|-----------------|-----------------|
| (1) Upto 1200 K | (2) Upto 2200 K |
| (3) Upto 1900 K | (4) Upto 5000 K |

Answer (2)

Sol. Maximum temperature that can be achieved in blast furnace is upto 2200 K.

(As per NCERT text: 2170 K maximum temperature is given in the figure of blast furnace)

56. **Statement I** : Acid strength increases in the order given as $HF \ll HCl \ll HBr \ll HI$.

Statement II : As the size of the elements F, Cl, Br, I increases down the group, the bond strength of HF, HCl, HBr and HI decreases and so the acid strength increases.

In the light of the above statements, choose the correct answer from the options given below.

- (1) Both statement I and Statement II are true
- (2) Both Statement I and Statement II are false
- (3) Statement I is correct but statement II is false
- (4) Statement I is incorrect but Statement II is true

Answer (1)

Sol. In the modern periodic table, moving down the group as the size of halogen atom increases, the H - X bond length also increases as a result the bond enthalpy decreases. Hence, The acidic strength also increases.

So, the correct order of acidic strength is

$$HI > HBr > HCl > HF$$

57. The compound which shows metamerism is :

- (1) C_5H_{12} (2) C_3H_8O
 (3) C_3H_6O (4) $C_4H_{10}O$

Answer (4)

Sol. Compounds with formula $C_4H_{10}O$ can be ethers which may exhibit metamerism. For example

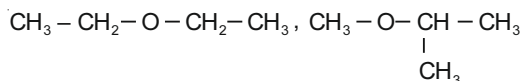

and $CH_3 - O - CH_2 - CH_2 - CH_3$ are metamers as structure of alkyl chains are different around the functional group.

58. For a reaction $A \rightarrow B$, enthalpy of reaction is -4.2 kJ mol^{-1} and enthalpy of activation is 9.6 kJ mol^{-1} . The correct potential energy profile for the reaction is shown in option.

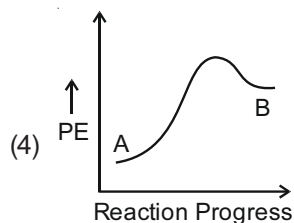
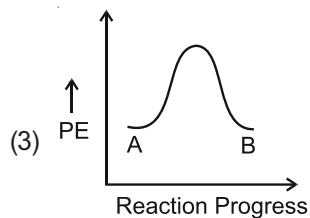
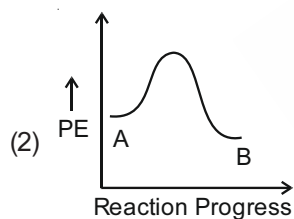
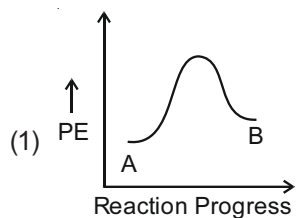

Answer (2)

Sol. • $\Delta H_{\text{rxn}} = (E_a)_f - (E_a)_b$
 $-4.2 = (E_a)_f - (E_a)_b$
 $-4.2 = 9.6 - (E_a)_b$
 $(E_a)_b = 9.6 + 4.2 = 13.8 \text{ kJ mol}^{-1}$

- Since reaction is exothermic, so possible graph is (3) only.
- Also $(E_a)_f < (E_a)_b$, so answer is option (2).

59. The right option for the statement "Tyndall effect is exhibited by", is :

- (1) NaCl solution
 (2) Glucose solution
 (3) Starch solution
 (4) Urea solution

Answer (3)

Sol. • Tyndall effect is exhibited by colloidal solution only.

- Among the given options, Urea, NaCl and Glucose solutions are true solutions, so cannot show Tyndall effect.
- Starch solution is a colloidal solution therefore can show Tyndall effect.

60. BF_3 is planar and electron deficient compound. Hybridization and number of electrons around the central atom, respectively are :

- (1) sp^3 and 4 (2) sp^3 and 6
 (3) sp^2 and 6 (4) sp^2 and 8

Answer (3)

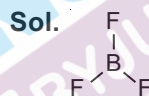

- Number of electrons around boron atom is 6.
- Hybridization of B is sp^2 .
- Shape is trigonal planar.

61. Match List-I with List-II.

- | List-I | List-II |
|-------------|---------------------------|
| (a) PCl_5 | (i) Square pyramidal |
| (b) SF_6 | (ii) Trigonal planar |
| (c) BrF_5 | (iii) Octahedral |
| (d) BF_3 | (iv) Trigonal bipyramidal |

Choose the correct answer from the options given below.

- (1) (a)-(iv), (b)-(iii), (c)-(i), (d)-(ii)
 (2) (a)-(ii), (b)-(iii), (c)-(iv), (d)-(i)
 (3) (a)-(iii), (b)-(i), (c)-(iv), (d)-(ii)
 (4) (a)-(iv), (b)-(iii), (c)-(ii), (d)-(i)

Answer (1)

Sol.

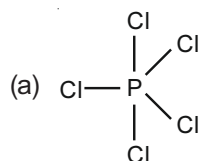

sp^3d hybridised and trigonal bipyramidal in shape

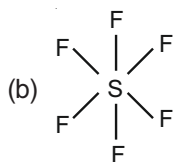

sp^3d^2 hybridised and octahedral in shape

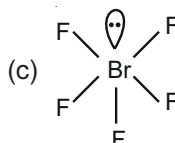

sp^3d^2 hybridised and square pyramidal in shape

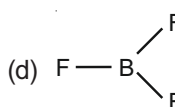

sp^2 hybridised and trigonal planar in shape

62. The structures of beryllium chloride in solid state and vapour phase, are :

- (1) Chain and dimer, respectively
- (2) Linear in both
- (3) Dimer and Linear, respectively
- (4) Chain in both

Answer (1)

Sol. Beryllium chloride has a chain structure in the solid state as shown below

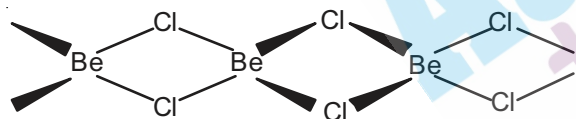

In vapour phase Beryllium chloride tends to form a chloro-bridged dimer.

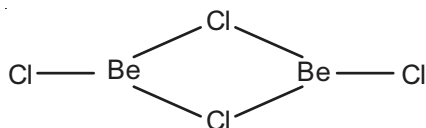

63. The correct sequence of bond enthalpy of 'C—X' bond is :

- (1) $CH_3 - F < CH_3 - Cl < CH_3 - Br < CH_3 - I$
- (2) $CH_3 - F > CH_3 - Cl > CH_3 - Br > CH_3 - I$
- (3) $CH_3 - F < CH_3 - Cl > CH_3 - Br > CH_3 - I$
- (4) $CH_3 - Cl > CH_3 - F > CH_3 - Br > CH_3 - I$

Answer (2)

Sol. The size of halogen atom increases from F to I hence bond length from C – F to C – I increases

∴ Bond enthalpy from $CH_3 - F$ to $CH_3 - I$ decreases

C – X Bond	Bond dissociation enthalpies/kJ mol ⁻¹
$CH_3 - F$	452
$CH_3 - Cl$	351
$CH_3 - Br$	293
$CH_3 - I$	234

64. Which one of the following polymers is prepared by addition polymerisation?

- (1) Teflon
- (2) Nylon-66
- (3) Novolac
- (4) Dacron

Answer (1)

Sol. Dacron, Nylon-66 and Novolac are prepared by condensation polymerisation.

Teflon is an addition polymer. Monomer of teflon is tetrafluoroethene.

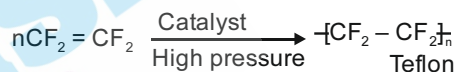

Tetrafluoroethene

Teflon

65. Dihedral angle of least stable conformer of ethane is :

- (1) 120°
- (2) 180°
- (3) 60°
- (4) 0°

Answer (4)

Sol. Ethane has two conformers (i) Eclipsed

(ii) Staggered

Eclipsed conformer is least stable while staggered conformer is most stable. In eclipsed conformer the dihedral angle is 0°

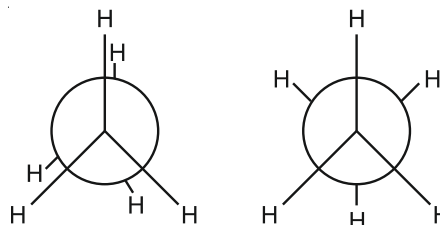

Eclipsed
Dihedral angle = 0°

Staggered
Dihedral angle = 60°

66. An organic compound contains 78% (by wt.) carbon and remaining percentage of hydrogen. The right option for the empirical formula of this compound is : [Atomic wt. of C is 12, H is 1]

- (1) CH (2) CH₂
 (3) CH₃ (4) CH₄

Answer (3)

Sol.	Element	Mass percentage	No. of mole	Mole ratio
	C	78%	$\frac{78}{12} = 6.5$	$\frac{6.5}{6.5} = 1$
	H	22%	$\frac{22}{1} = 22$	$\frac{22}{6.5} = 3.38 \approx 3$

Based on above calculation, possible empirical formula is CH₃.

67. The molar conductance of NaCl, HCl and CH₃COONa at infinite dilution are 126.45, 426.16 and 91.0 S cm² mol⁻¹ respectively. The molar conductance of CH₃COOH at infinite dilution is. Choose the right option for your answer.

- (1) 201.28 S cm² mol⁻¹
 (2) 390.71 S cm² mol⁻¹
 (3) 698.28 S cm² mol⁻¹
 (4) 540.48 S cm² mol⁻¹

Answer (2)

Sol. According to Kohlrausch law of independent migration of ions.

$$\begin{aligned} \Lambda_m^{\circ}(\text{CH}_3\text{COOH}) &= \Lambda_m^{\circ}(\text{CH}_3\text{COONa}) + \Lambda_m^{\circ}(\text{HCl}) - \Lambda_m^{\circ}(\text{NaCl}) \\ &= 91.0 \text{ S cm}^2 \text{ mol}^{-1} + 426.16 \text{ S cm}^2 \text{ mol}^{-1} \\ &\quad - 126.45 \text{ S cm}^2 \text{ mol}^{-1} \\ &= 390.71 \text{ S cm}^2 \text{ mol}^{-1} \end{aligned}$$

68. Given below are two statements :

Statement I :

Aspirin and Paracetamol belong to the class of narcotic analgesics.

Statement II :

Morphine and Heroin are non-narcotic analgesics. In the light of the above statements, choose the correct answer from the options given below.

- (1) Both **Statement I** and **Statement II** are true
 (2) Both **Statement I** and **Statement II** are false
 (3) **Statement I** is correct but **Statement II** is false
 (4) **Statement I** is incorrect but **Statement II** is true.

Answer (2)

Sol. ● Aspirin and paracetamol belong to the class of non-narcotic analgesics

● Morphine and Heroin are Narcotic analgesics

∴ Both statement I and statement II are false

69. The following solutions were prepared by dissolving 10 g of glucose (C₆H₁₂O₆) in 250 ml of water (P₁), 10 g of urea (CH₄N₂O) in 250 ml of water (P₂) and 10 g of sucrose (C₁₂H₂₂O₁₁) in 250 ml of water (P₃). The right option for the decreasing order of osmotic pressure of these solutions is :

- (1) P₂ > P₁ > P₃ (2) P₁ > P₂ > P₃
 (3) P₂ > P₃ > P₁ (4) P₃ > P₁ > P₂

Answer (1)

Sol. ● Osmotic pressure (π) = $iCRT$

where C is molar concentration of the solution

- With increase in molar concentration of solution osmotic pressure increases.
- Since, weight of all solutes and its solution volume are equal, so higher will be the molar mass of solute, smaller will be molar concentration and smaller will be the osmotic pressure.
- Order of molar mass of solute decreases as Sucrose > Glucose > Urea
- So, correct order of osmotic pressure of solution is P₃ < P₁ < P₂

70. Among the following alkaline earth metal halides, one which is covalent and soluble in organic solvents is :

- (1) Calcium chloride
 (2) Strontium chloride
 (3) Magnesium chloride
 (4) Beryllium chloride

Answer (4)

Sol. ● Except for beryllium chloride all other chloride of alkaline earth metals are ionic in nature.

- Due to small size of Be, Beryllium chloride is essentially covalent and soluble in organic solvents.

71. Identify the compound that will react with Hinsberg's reagent to give a solid which dissolves in alkali.

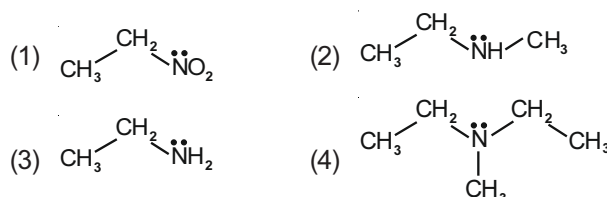

Answer (3)

Sol. ● Benzenesulphonyl chloride ($C_6H_5SO_2Cl$) is also known as Hinsberg's reagent.

- The reaction of Hinsberg's reagent ($C_6H_5SO_2Cl$) with primary amine ($CH_3CH_2NH_2$) yields N-ethylbenzene sulphonamide.

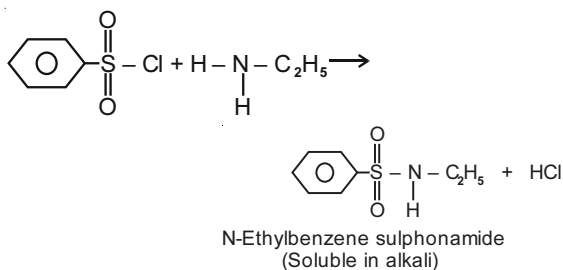

- The reaction of Hinsberg's reagent ($C_6H_5SO_2Cl$) with secondary amine ($C_2H_5NHCH_3$) gives, N-Ethyl-N-Methyl benzene sulphonamide

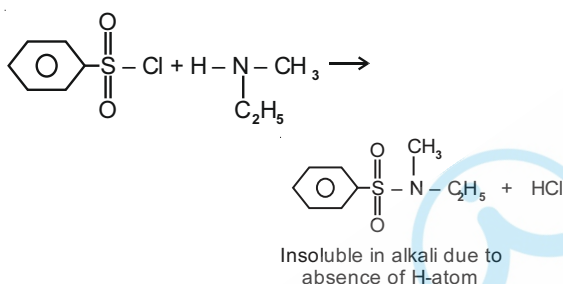

- 3° amine do not react with Hinsberg reagent

72. Right option for the number of tetrahedral and octahedral voids in hexagonal primitive unit cell are :

- (1) 8, 4 (2) 6, 12
(3) 2, 1 (4) 12, 6

Answer (4)

Sol. ● Number of octahedral and tetrahedral voids formed by N closed packed atoms are N and 2N respectively.

- Each hexagonal unit cell contains 6 atoms therefore, number of tetrahedral and octahedral voids are 12 and 6 respectively.

73. The correct structure of 2, 6-Dimethyl-dec-4-ene is

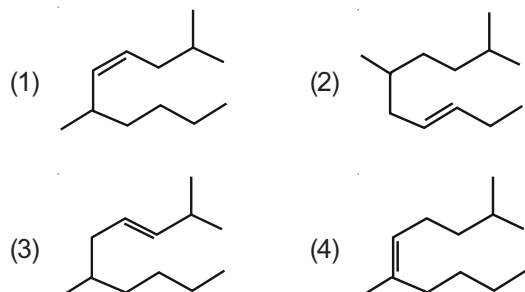

Answer (1)

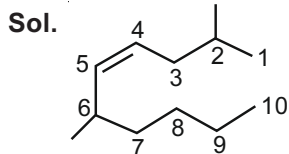

2, 6-Dimethyldec-4-ene

74. The RBC deficiency is deficiency disease of :

- (1) Vitamin B₁₂ (2) Vitamin B₆
(3) Vitamin B₁ (4) Vitamin B₂

Answer (1)

Sol. ● Deficiency of vitamin B₂ (Riboflavin) causes cheilosis, digestive disorders and burning sensation of the skin.

- Deficiency of vitamin B₁₂ causes Pernicious anaemia which is RBC deficiency in haemoglobin.
- Deficiency of vitamin B₆ (Pyridoxine) causes Convulsions.
- Deficiency of vitamin B₁ (Thiamine) causes Beri-Beri (loss of appetite and retarded growth).

75. Which one of the following methods can be used to obtain highly pure metal which is liquid at room temperature?

- (1) Electrolysis (2) Chromatography
(3) Distillation (4) Zone refining

Answer (3)

Sol. Distillation method is generally used for the purification of metals having low boiling point such as Hg, Zn etc.

76. What is the IUPAC name of the organic compound formed in the following chemical reaction?

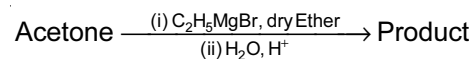

- (1) 2-methylpropan-2-ol (2) pentan-2-ol
(3) pentan-3-ol (4) 2-methylbutan-2-ol

Answer (4)

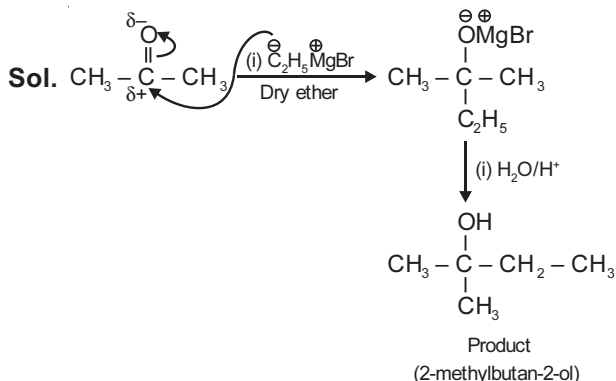

77. The major product of the following chemical reaction is :

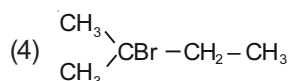
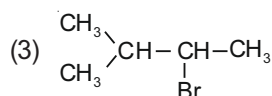
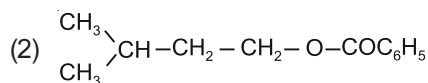
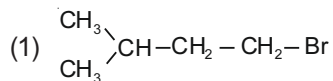
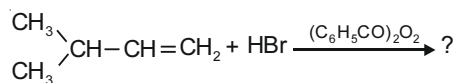

Answer (1)

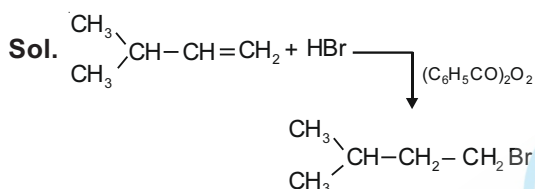

Mechanism : Peroxide effect proceeds via free radical chain mechanism.

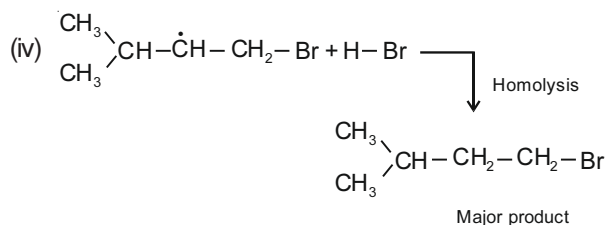
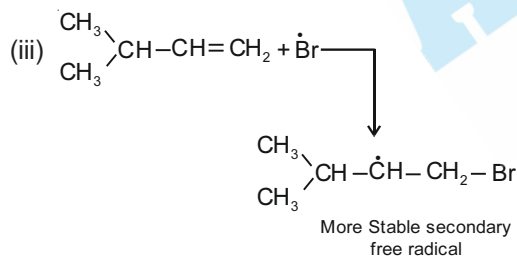
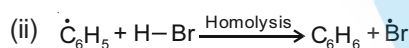
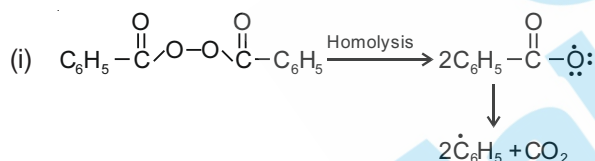

78. The incorrect statement among the following is :

- (1) Actinoid contraction is greater for element than lanthanoid contraction
- (2) Most of the trivalent Lanthanoid ions are colorless in the solid state

(3) Lanthanoids are good conductors of heat and electricity

(4) Actinoids are highly reactive metals, especially when finely divided.

Answer (2)

Sol. • Actinoids are highly reactive metals, especially when finely divided

• Actinoid contraction is greater from element to element than lanthanoid contraction resulting from poor shielding by 5f electrons

• Many trivalent lanthanoids ions are coloured both in the solid state and in aqueous solutions.

• Lanthanoids have typical metallic structure and are good conductors of heat and electricity

79. A particular station of All India Radio, New Delhi broadcasts on a frequency of 1,368 kHz (kilohertz). The wavelength of the electromagnetic radiation emitted by the transmitter is : [speed of light $c = 3.0 \times 10^8 \text{ ms}^{-1}$]

(1) 219.3 m

(2) 219.2 m

(3) 2192 m

(4) 21.92 cm

Answer (1)

Sol. Energy of electromagnetic radiation (E)

$$= \frac{hc}{\lambda} = h\nu$$

$$\text{So, } \frac{c}{\lambda} = \nu \quad \Rightarrow \quad \lambda = \frac{c}{\nu}$$

$$\lambda = \frac{3 \times 10^8}{1368 \times 10^3} = 219.3 \text{ m}$$

80. Which of the following reactions is the metal displacement reaction? Choose the right option.

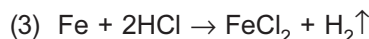
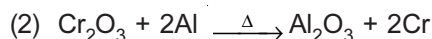
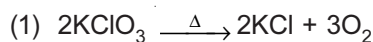

Answer (2)

Sol. • Both reactions (1) and (2) are examples of decomposition reactions.

• Reactions (3) and (4), both are examples of displacement reactions, while reaction (3) is an example of metal displacement reaction.

81. Choose the correct option for graphical representation of Boyle's law, which shows a graph of pressure vs. volume of a gas at different temperatures :

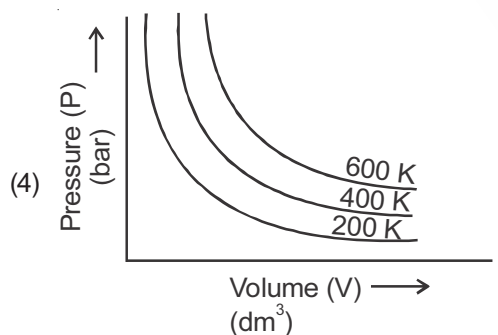
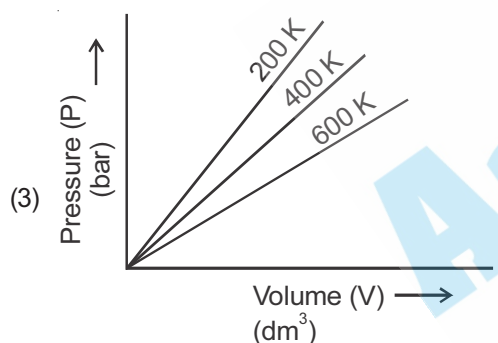
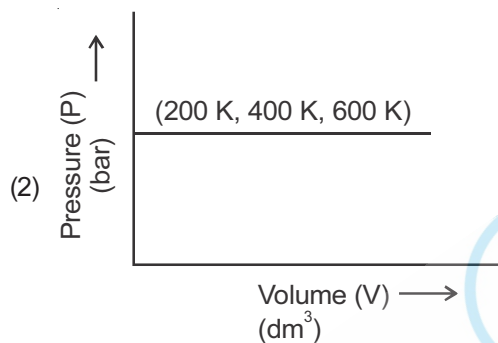
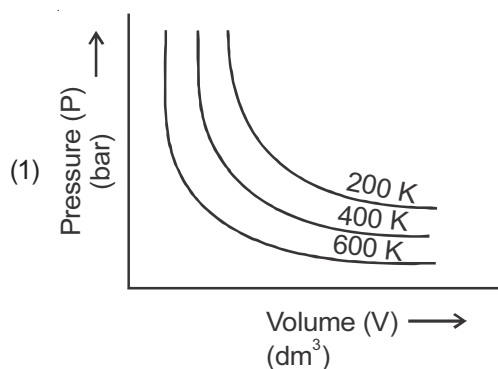

Answer (4)

Sol. According to Boyle's law

$$P \propto \frac{1}{V} \Rightarrow P = \frac{k}{V} \Rightarrow PV = k$$

where k is proportionality constant and equal to nRT.

∴ Graph between P vs. V should be rectangular hyperbola and product of PV increases with increase in temperature.

82. The pK_b of dimethylamine and pK_a of acetic acid are 3.27 and 4.77 respectively at T (K). The correct option for the pH of dimethylammonium acetate solution is :

- (1) 8.50 (2) 5.50
(3) 7.75 (4) 6.25

Answer (3)

Sol. Dimethylammonium acetate is a salt of weak acid and weak base whose pH can be calculated as

$$\begin{aligned} \text{pH} &= 7 + \frac{1}{2}(\text{p}K_a - \text{p}K_b) \\ &= 7 + \frac{1}{2}(4.77 - 3.27) \\ &= 7.75 \end{aligned}$$

83. The major product formed in dehydrohalogenation reaction of 2-Bromo pentane is Pent-2-ene. This product formation is based on?

- (1) Saytzeff's Rule
(2) Hund's Rule
(3) Hofmann Rule
(4) Huckel's Rule

Answer (1)

Sol. Major product formed in dehydrohalogenation reaction of 2-bromopentane is pent-2-ene because according to Saytzeff's rule, in dehydrohalogenation reactions, the preferred product is that alkene which has greater number of alkyl group(s) attached to the doubly bonded carbon atoms.

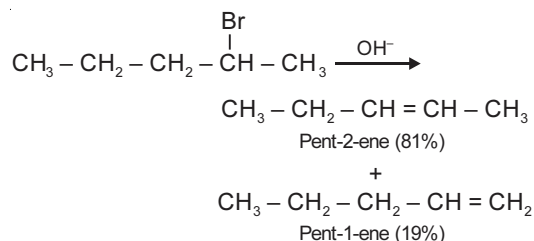

84. Ethylene diaminetetraacetate (EDTA) ion is :

- (1) Hexadentate ligand with four "O" and two "N" donor atoms
(2) Unidentate ligand
(3) Bidentate ligand with two "N" donor atoms
(4) Tridentate ligand with three "N" donor atoms

Answer (1)

Sol. Ethylene diaminetetraacetate (EDTA) ion is a hexadentate ligand having four donor oxygen atoms and two donor nitrogen atoms

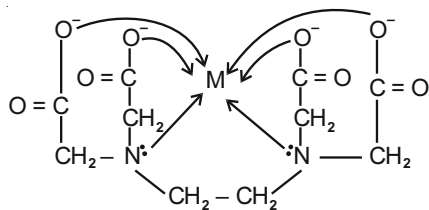

85. Tritium, a radioactive isotope of hydrogen, emits which of the following particles?

- (1) Beta (β^-)
- (2) Alpha (α)
- (3) Gamma (γ)
- (4) Neutron (n)

Answer (1)

Sol. Hydrogen has three isotopes : protium, ${}^1_1\text{H}$ deuterium, ${}^2_1\text{H}$ or D and tritium ${}^3_1\text{H}$ or T. Of these isotopes, only tritium is radioactive and emits low energy β^- particles ($t_{1/2}$, 12.33 years).

SECTION - B

86. Match List-I with List-II.

List-I	List-II
(a) $[\text{Fe}(\text{CN})_6]^{3-}$	(i) 5.92 BM
(b) $[\text{Fe}(\text{H}_2\text{O})_6]^{3+}$	(ii) 0 BM
(c) $[\text{Fe}(\text{CN})_6]^{4-}$	(iii) 4.90 BM
(d) $[\text{Fe}(\text{H}_2\text{O})_6]^{2+}$	(iv) 1.73 BM

Choose the correct answer from the options given below.

- (1) (a)-(iv), (b)-(ii), (c)-(i), (d)-(iii)
- (2) (a)-(ii), (b)-(iv), (c)-(iii), (d)-(i)
- (3) (a)-(i), (b)-(iii), (c)-(iv), (d)-(ii)
- (4) (a)-(iv), (b)-(i), (c)-(ii), (d)-(iii)

Answer (4)

Sol. Magnetic moment, $\mu = \sqrt{n(n+2)}$ BM (where n = number of unpaired electrons)

Complex	No. of unpaired electron(s)	μ (BM)
(a) $[\text{Fe}(\text{CN})_6]^{3-}$	1	1.73
(b) $[\text{Fe}(\text{H}_2\text{O})_6]^{3+}$	5	5.92
(c) $[\text{Fe}(\text{CN})_6]^{4-}$	0	0
(d) $[\text{Fe}(\text{H}_2\text{O})_6]^{2+}$	4	4.90

87. In which one of the following arrangements the given sequence is not strictly according to the properties indicated against it?

- (1) $\text{HF} < \text{HCl} < \text{HBr} < \text{HI}$: Increasing acidic strength
- (2) $\text{H}_2\text{O} < \text{H}_2\text{S} < \text{H}_2\text{Se} < \text{H}_2\text{Te}$: Increasing pK_a values
- (3) $\text{NH}_3 < \text{PH}_3 < \text{AsH}_3 < \text{SbH}_3$: Increasing acidic character
- (4) $\text{CO}_2 < \text{SiO}_2 < \text{SnO}_2 < \text{PbO}_2$: Increasing oxidizing power

Answer (2)

Sol. Stronger is the acid, lower is the value of pK_a . On moving down the group, bond dissociation enthalpy of hydrides of group 16 elements decreases hence acidity increases and pK_a value decreases. Correct order of pK_a value will be

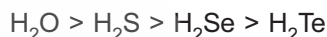

88. Choose the **correct** option for the total pressure (in atm.) in a mixture of 4 g O_2 and 2 g H_2 confined in a total volume of one litre at 0°C is :

[Given $R = 0.082 \text{ L atm mol}^{-1}\text{K}^{-1}$, $T = 273 \text{ K}$]

- (1) 2.518
- (2) 2.602
- (3) 25.18
- (4) 26.02

Answer (3)

Sol. $n_{\text{O}_2} = \frac{4}{32} = \frac{1}{8}$

$$n_{\text{H}_2} = \frac{2}{2} = 1$$

$$n_t = \frac{1}{8} + 1 = \frac{9}{8}$$

$$P_t V = n_t RT$$

$$P_t = \frac{\frac{9}{8} \times 0.082 \times 273}{1} = 25.18 \text{ atm}$$

89. Which of the following molecules is non-polar in nature?

- (1) POCl_3
- (2) CH_2O
- (3) SbCl_5
- (4) NO_2

Answer (3)

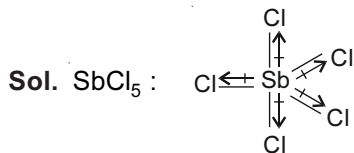

Net vector summation of bond moments will be zero so SbCl_5 is a non-polar molecule.

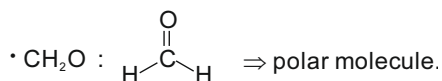
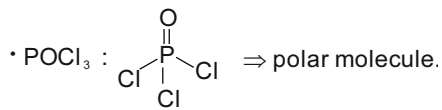
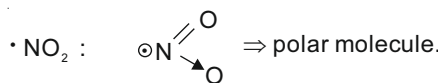

90. The product formed in the following chemical reaction is:

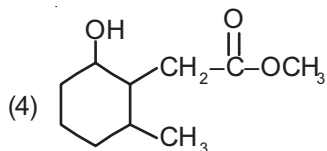
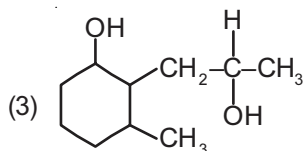
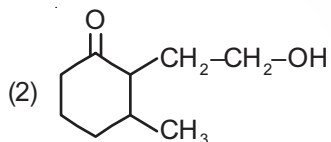
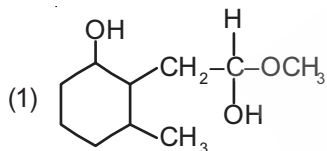
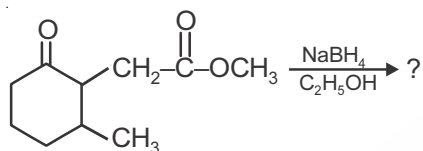

Answer (4)

Sol. NaBH_4 is a reducing agent. It reduces carbonyl group into alcohols but does not reduce esters.

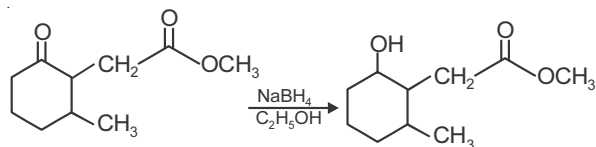

91. The slope of Arrhenius plot $\left(\ln k \text{ vs } \frac{1}{T}\right)$ of first order reaction is $-5 \times 10^3 \text{K}$. The value of E_a of the reaction is. Choose the correct option for your answer.

[Given $R = 8.314 \text{ JK}^{-1}\text{mol}^{-1}$]

- (1) 41.5 kJ mol^{-1} (2) 83.0 kJ mol^{-1}
(3) 166 kJ mol^{-1} (4) -83 kJ mol^{-1}

Answer (1)

Sol. Arrhenius equation

$$k = Ae^{-E_a/RT}$$

$$\ln k = \ln A + \ln e^{-E_a/RT}$$

$$\ln k = \ln A - \frac{E_a}{R} \left(\frac{1}{T}\right) \longrightarrow (1)$$

Slope of $\ln k \text{ vs } \frac{1}{T}$ curve,

$$m = -\frac{E_a}{R}$$

$$-5 \times 10^3 = -\frac{E_a}{R}$$

$$\begin{aligned} E_a &= 5 \times 10^3 \times 8.314 \text{ J/mol} \\ &= 41.57 \times 10^3 \text{ J/mol} \\ &\approx 41.5 \text{ kJ/mol} \end{aligned}$$

92. Match List-I with List-II

List-I	List-II
(a)	(i) Hell-Volhard-Zelinsky reaction
(b) $\text{R}-\overset{\text{O}}{\parallel}{\text{C}}-\text{CH}_3 + \text{NaOX} \longrightarrow$	(ii) Gattermann-Koch reaction
(c) $\text{R}-\text{CH}_2-\text{OH} + \text{R}'\text{COOH} \xrightarrow{\text{Conc. H}_2\text{SO}_4}$	(iii) Haloform reaction
(d) $\text{R}-\text{CH}_2\text{COOH} \xrightarrow[\text{(ii) H}_2\text{O}]{\text{(i) X}_2/\text{Red P}}$	(iv) Esterification

Choose the **correct** answer from the options given below.

- (1) (a) - (iv), (b) - (i), (c) - (ii), (d) - (iii)
(2) (a) - (iii), (b) - (ii), (c) - (i), (d) - (iv)
(3) (a) - (i), (b) - (iv), (c) - (iii), (d) - (ii)
(4) (a) - (ii), (b) - (iii), (c) - (iv), (d) - (i)

Answer (4)

Sol. • Gattermann-Koch reaction:

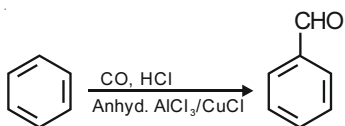

• Haloform reaction:

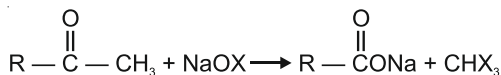

• Esterification:

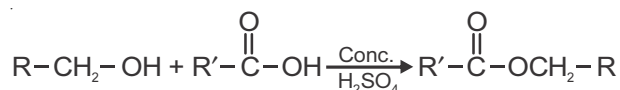

• Hell-Volhard-Zelinsky reaction:

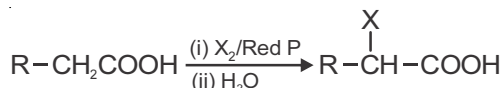

93. For irreversible expansion of an ideal gas under isothermal condition, the correct option is:

- (1) $\Delta U = 0, \Delta S_{\text{total}} = 0$
- (2) $\Delta U \neq 0, \Delta S_{\text{total}} \neq 0$
- (3) $\Delta U = 0, \Delta S_{\text{total}} \neq 0$
- (4) $\Delta U \neq 0, \Delta S_{\text{total}} = 0$

Answer (3)

Sol. • For a spontaneous process, $\Delta S_{\text{total}} > 0$ and since irreversible process is always spontaneous therefore $\Delta S_{\text{total}} > 0$.

• Since $\Delta U = nC_V\Delta T$ and $\Delta T = 0$ for isothermal process therefore $\Delta U = 0$.

94. The intermediate compound 'X' in the following chemical reaction is:

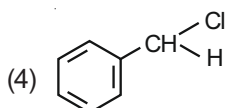
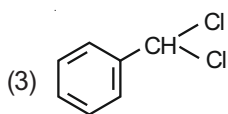
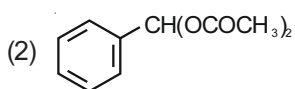
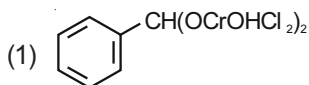
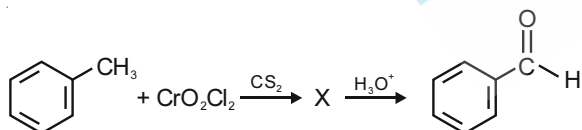

Answer (1)

Sol. Etard's reaction

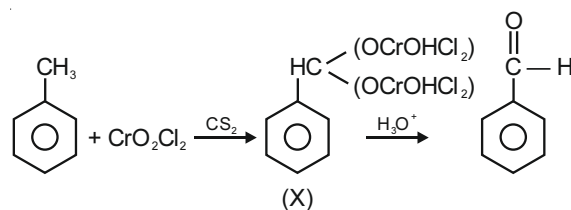

95. Match List-I with List-II.

- | List-I | List-II |
|---|-----------------------------|
| (a) $2\text{SO}_2(\text{g}) + \text{O}_2(\text{g}) \rightarrow 2\text{SO}_3(\text{g})$ | (i) Acid rain |
| (b) $\text{HOCl}(\text{g}) \xrightarrow{h\nu} \overset{\cdot}{\text{O}}\text{H} + \overset{\cdot}{\text{Cl}}$ | (ii) Smog |
| (c) $\text{CaCO}_3 + \text{H}_2\text{SO}_4 \rightarrow \text{CaSO}_4 + \text{H}_2\text{O} + \text{CO}_2$ | (iii) Ozone depletion |
| (d) $\text{NO}_2(\text{g}) \xrightarrow{h\nu} \text{NO}(\text{g}) + \text{O}(\text{g})$ | (iv) Tropospheric pollution |

Choose the **correct** answer from the options given below.

- (1) (a)-(i), (b)-(ii), (c)-(iii), (d)-(iv)
- (2) (a)-(ii), (b)-(iii), (c)-(iv), (d)-(i)
- (3) (a)-(iv), (b)-(iii), (c)-(i), (d)-(ii)
- (4) (a)-(iii), (b)-(ii), (c)-(iv), (d)-(i)

Answer (3)

Sol. • Tropospheric pollution: In the presence of pollutant, SO_2 converts into SO_3 .

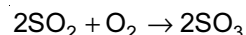

• In spring season, sunlight breaks HOCl and Cl_2 to give chlorine radicals.

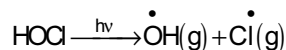

These chlorine radicals deplete ozone layer

• High level of sulphur causes acid rain which reacts with marble and causes discolouring and disfiguring

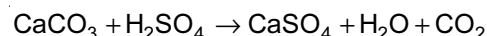

• A chain reaction occurs from interaction of NO with sunlight in which NO is converted to NO_2 which absorb energy from sunlight and breaks into NO and O, which causes photochemical smog.

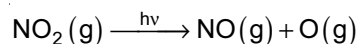

96. The molar conductivity of 0.007 M acetic acid is 20 S cm² mol⁻¹. What is the dissociation constant of acetic acid? Choose the **correct** option.

$$\left[\begin{array}{l} \Lambda_{\text{H}^+}^{\circ} = 350 \text{ S cm}^2 \text{ mol}^{-1} \\ \Lambda_{\text{CH}_3\text{COO}^-}^{\circ} = 50 \text{ S cm}^2 \text{ mol}^{-1} \end{array} \right]$$

- (1) $1.75 \times 10^{-4} \text{ mol L}^{-1}$ (2) $2.50 \times 10^{-4} \text{ mol L}^{-1}$
(3) $1.75 \times 10^{-5} \text{ mol L}^{-1}$ (4) $2.50 \times 10^{-5} \text{ mol L}^{-1}$

Answer (3)

Sol. $\Lambda_m = 20 \text{ S cm}^2 \text{ mol}^{-1}$

$$\Lambda_m^{\circ} \text{CH}_3\text{COOH} = \Lambda_m^{\circ} \text{CH}_3\text{COO}^- + \Lambda_m^{\circ} \text{H}^+$$

$$= 50 + 350 = 400 \text{ S cm}^2 \text{ mol}^{-1}$$

$$\alpha = \frac{\Lambda_m}{\Lambda_m^{\circ}} = \frac{20}{400} = \frac{1}{20}$$

$$K_a = \frac{C\alpha^2}{1-\alpha} = C\alpha^2 = 7 \times 10^{-3} \times \left(\frac{1}{20}\right)^2$$

$$= 7 \times 10^{-3} \times \frac{1}{4} \times 10^{-2}$$

$$= 1.75 \times 10^{-5} \text{ mol L}^{-1}$$

97. From the following pairs of ions which one is not an iso-electronic pair?

- (1) O²⁻, F⁻ (2) Na⁺, Mg²⁺
(3) Mn²⁺, Fe³⁺ (4) Fe²⁺, Mn²⁺

Answer (4)

Sol. • Isoelectronic species have same number of electrons.

Species	Number of electrons
Fe ²⁺	26 - 2 = 24
Mn ²⁺	25 - 2 = 23
O ²⁻	8 + 2 = 10
F ⁻	9 + 1 = 10
Na ⁺	11 - 1 = 10
Mg ²⁺	12 - 2 = 10
Fe ³⁺	26 - 3 = 23

98. The reagent 'R' in the given sequence of chemical reaction is:

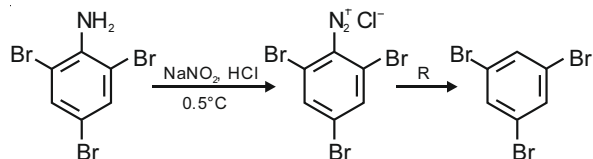

- (1) H₂O (2) CH₃CH₂OH
(3) HI (4) CuCN/KCN

Answer (2)

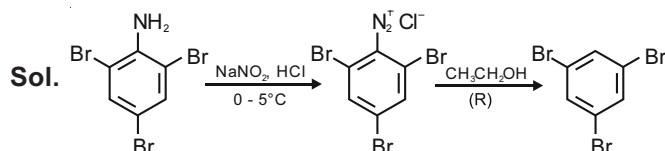

Reagent R is C₂H₅OH with diazonium salt.

99. The correct option for the value of vapour pressure of a solution at 45°C with benzene to octane in molar ratio 3 : 2 is :

[At 45°C vapour pressure of benzene is 280 mm Hg and that of octane is 420 mm Hg. Assume Ideal gas]

- (1) 160 mm of Hg (2) 168 mm of Hg
(3) 336 mm of Hg (4) 350 mm of Hg

Answer (3)

Sol. Given : $n_{\text{C}_6\text{H}_6} : n_{\text{C}_8\text{H}_{18}} = 3 : 2$

$$\text{So, } \chi_{\text{C}_6\text{H}_6} = \frac{3}{5}, \chi_{\text{C}_8\text{H}_{18}} = \frac{2}{5}$$

$$p_s = p_{\text{C}_6\text{H}_6}^{\circ} \chi_{\text{C}_6\text{H}_6} + p_{\text{C}_8\text{H}_{18}}^{\circ} \chi_{\text{C}_8\text{H}_{18}}$$

$$= 280 \times \frac{3}{5} + 420 \times \frac{2}{5}$$

$$= 168 + 168$$

$$= 336 \text{ mm of Hg}$$

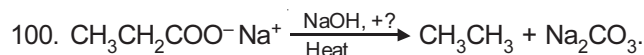

Consider the above reaction and identify the missing reagent/chemical.

- (1) B₂H₆ (2) Red Phosphorus
(3) CaO (4) DIBAL-H

Answer (3)

Sol. Alkane is produced by heating sodium salt of carboxylic acid with sodalime (NaOH and CaO in the ratio of 3 : 1)

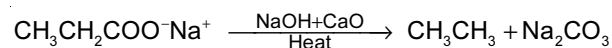

BOTANY

SECTION - A

101. Which of the following algae contains mannitol as reserve food material?

- (1) *Ectocarpus*
- (2) *Gracilaria*
- (3) *Volvox*
- (4) *Ulothrix*

Answer (1)

Sol. *Ectocarpus* is a brown alga belongs to the class Phaeophyceae. Members of this class have mannitol and laminarin as stored food material.

Ulothrix and *Volvox* belong to Chlorophyceae (green algae). Members of this class have starch as reserve food material. *Gracilaria* is a member of red algae (Rhodophyceae). This class is characterised by having floridean starch as stored food material.

102. Amensalism can be represented as:

- (1) Species A (-); Species B (0)
- (2) Species A (+); Species B (+)
- (3) Species A (-); Species B (-)
- (4) Species A (+); Species B (0)

Answer (1)

Sol. • Amensalism is an interaction between two organisms of different species in which one species inhibits the growth of other species by secreting certain chemicals. The first species is neither get benefited nor harmed.

- (+) : (0) interaction is observed in commensalism
- (+) : (+) interaction is observed in mutualism.
- (-) : (-) interaction is seen in competition

103. Match **List-I** with **List-II**.

List-I		List-II	
(a)	Cristae	(i)	Primary constriction in chromosome
(b)	Thylakoids	(ii)	Disc-shaped sacs in Golgi apparatus
(c)	Centromere	(iii)	Infoldings in mitochondria
(d)	Cisternae	(iv)	Flattened membranous sacs in stroma of plastids

Choose the **correct** answer from the options given below.

- | | (a) | (b) | (c) | (d) |
|-----|-------|-------|-------|------|
| (1) | (iv) | (iii) | (ii) | (i) |
| (2) | (i) | (iv) | (iii) | (ii) |
| (3) | (iii) | (iv) | (i) | (ii) |
| (4) | (ii) | (iii) | (iv) | (i) |

Answer (3)

Sol. • The inner membrane of mitochondria forms infoldings called cristae.

- Thylakoids are flattened membranous sacs in stroma of plastids.
- Cisternae are disc shaped sacs in Golgi apparatus.
- Primary constriction in chromosome that holds two chromatids together is called centromere.

Hence correct option is (3)- a(iii), b(iv), c(i), d(ii)

104. The plant hormone used to destroy weeds in a field

- (1) IAA
- (2) NAA
- (3) 2, 4-D
- (4) IBA

Answer (3)

Sol. Some synthetic auxins are used as weedicides. 2,4-D is widely used to remove broad leaved weeds or dicotyledonous weeds in cereal crops or monocotyledonous plants.

IAA and IBA are natural auxins.

NAA is a synthetic auxin.

105. Diadelphous stamens are found in

- (1) China rose
- (2) Citrus
- (3) Pea
- (4) China rose and citrus

Answer (3)

- Sol.**
- Stamens are said to be diadelphous when these are united in two bundles e.g. Pea.
 - China rose has monadelphous stamens while, *Citrus* has polyadelphous stamens. Monoadelphous stamens are grouped in single bundle whereas polyadelphous stamens occur in more than two bundles.

106. A typical angiosperm embryo sac at maturity is:

- (1) 8-nucleate and 7-celled
- (2) 7-nucleate and 8-celled
- (3) 7-nucleate and 7-celled
- (4) 8-nucleate and 8-celled

Answer (1)

Sol. A typical angiospermic embryo sac has seven cells that are three antipodals, one central cell, one egg cell and two synergids.

The central cell has two polar nuclei, hence the embryo sac is eight nucleated.

107. Which of the following is a **correct** sequence of steps in a PCR (Polymerase Chain Reaction)?

- (1) Denaturation, Annealing, Extension
- (2) Denaturation, Extension, Annealing
- (3) Extension, Denaturation, Annealing
- (4) Annealing, Denaturation, Extension

Answer (1)

Sol. The first step in the polymerase chain reaction is denaturation during which strands of dsDNA separate. This requires temperature around 94°C.

This is followed by annealing in which primers anneal to 3' end of template DNA strand.

Annealing is followed by extension in which *Taq* polymerase adds nucleotides to 3'OH end of primers.

108. The site of perception of light in plants during photoperiodism is

- (1) Shoot apex
- (2) Stem
- (3) Axillary bud
- (4) Leaf

Answer (4)

- Sol.**
- The site of perception of light in plants during photoperiodism is leaf.
 - The site of perception of low temperature stimulus during vernalisation is shoot apex and embryo.
 - Axillary bud are not sites of perception of photoperiod.

109. Which of the following is an **incorrect** statement?

- (1) Mature sieve tube elements possess a conspicuous nucleus and usual cytoplasmic organelles
- (2) Microbodies are present both in plant and animal cells
- (3) The perinuclear space forms a barrier between the materials present inside the nucleus and that of the cytoplasm
- (4) Nuclear pores act as passages for proteins and RNA molecules in both directions between nucleus and cytoplasm

Answer (1)

Sol. A mature sieve tube elements possess a peripheral cytoplasm and a large central vacuole but lacks a nucleus.

Rest of other statements are correct.

110. The first stable product of CO₂ fixation in Sorghum is

- (1) Pyruvic acid
- (2) Oxaloacetic acid
- (3) Succinic acid
- (4) Phosphoglyceric acid

Answer (2)

Sol. • *Sorghum* is a C₄ plant. The first stable product of CO₂ fixation in *Sorghum* is oxaloacetic acid.

- The first stable product in C₃ cycle is 3-phosphoglyceric acid.
- Pyruvic acid is the end product of glycolysis.
- Succinic acid is an intermediate product in krebs cycle.

111. When gene targeting involving gene amplification is attempted in an individual's tissue to treat disease, it is known as :

- (1) Biopiracy
- (2) Gene therapy
- (3) Molecular diagnosis
- (4) Safety testing

Answer (2)

Sol. The correct option is (2)

- Gene therapy is a collection of methods that allows correction of a gene defect that has been diagnosed in a child/embryo.
- Biopiracy is the term used to refer to the use of bio-resources by multinational companies and other organisations without proper authorisation from the countries and people concerned without compensatory payment.
- Molecular diagnosis refers to the act or process of determining the nature and cause of a disease.

112. Match **List-I** with **List-II**

List-I		List-II	
(a)	Protoplast fusion	(i)	Totipotency
(b)	Plant tissue culture	(ii)	Pomato
(c)	Meristem culture	(iii)	Somaclones
(d)	Micropropagation	(iv)	Virus free plants

Choose the **correct** answer from the options given below.

- | | (a) | (b) | (c) | (d) |
|-----|-------|-------|------|-------|
| (1) | (iii) | (iv) | (ii) | (i) |
| (2) | (ii) | (i) | (iv) | (iii) |
| (3) | (iii) | (iv) | (i) | (ii) |
| (4) | (iv) | (iii) | (ii) | (i) |

Answer (2)

- Sol.**
- Pomato is obtained as a result of protoplast fusion.
 - Totipotency is a property of explant to develop into whole plant body during plant tissue culture.
 - Virus free plants can be obtained through meristem culture.
 - Somaclones are obtained by the process of micropropagation.

113. Which of the following stages of meiosis involves division of centromere?

- (1) Metaphase I
- (2) Metaphase II
- (3) Anaphase II
- (4) Telophase II

Answer (3)

- Sol.**
- Division of centromere occurs in anaphase II.
 - Telophase II is the last stage of meiosis II. During this phase, the chromatids reach the poles and start uncoiling.
 - Chromosomes form two parallel plates in metaphase I and one plate in metaphase II.

114. Which of the following are **not** secondary metabolites in plants?

- (1) Morphine, codeine
- (2) Amino acids, glucose
- (3) Vinblastin, curcumin
- (4) Rubber, gums

Answer (2)

Sol. The correct option is (2)

- Amino acids and glucose are included under the category of primary metabolites as they have identifiable functions and play known roles in normal physiological processes.
- Rubber, gums, morphine, codeine, vinblastin and curcumin are included under the category of secondary metabolites as their role or functions in host organisms is not known yet. However, many of them are useful to human welfare.

115. Which of the following plants is monoecious?

- (1) *Carica papaya*
- (2) *Chara*
- (3) *Marchantia polymorpha*
- (4) *Cycas circinalis*

Answer (2)

- Sol.**
- When male and female sex organs are present on same plant body, such plants are said to be monoecious.
 - Most of the species of *Chara* are monoecious.
 - *Cycas circinalis*, *Carica papaya* and *Marchantia polymorpha* are dioecious.

116. Mutations in plant cells can be induced by:

- (1) Kinetin
- (2) Infrared rays
- (3) Gamma rays
- (4) Zeatin

Answer (3)

Sol. • Several kinds of radiation like gamma rays, X-rays, UV-rays cause mutation.

- These are physical mutagens.
- Such induced mutation in plants is done to develop improved varieties. The first natural cytokinin was isolated from unripe maize grain known as zeatin. The cytokinin that was obtained from degraded product of autoclaved herring sperm DNA was kinetin (N⁶-furfuryl aminopurine). Infrared rays cause heating effect.

117. During the purification process for recombinant DNA technology, addition of chilled ethanol precipitates out :

- (1) RNA
- (2) DNA
- (3) Histones
- (4) Polysaccharides

Answer (2)

Sol. Various enzymes like protease, RNase, etc. are added to break down substances like proteins, RNA, etc. Once all these substances are broken down, DNA is left which is precipitated out by adding chilled ethanol.

Histones are basic proteins that help condense DNA in a cell.

118. Plants follow different pathways in response to environment or phases of life to form different kinds of structures. This ability is called

- (1) Elasticity
- (2) Flexibility
- (3) Plasticity
- (4) Maturity

Answer (3)

Sol. Plants show plasticity which means the ability of plant to follow different pathways and produce different structures in response to environment.

119. Which of the following is **not** an application of PCR (Polymerase Chain Reaction)?

- (1) Molecular diagnosis
- (2) Gene amplification
- (3) Purification of isolated protein
- (4) Detection of gene mutation

Answer (3)

Sol. PCR is Polymerase Chain Reaction.

It is used for making multiple copies of the gene.

Hence PCR is used for

- Gene amplification.
- PCR-based assays have been developed that detect the presence of gene sequences of the infectious agents.
- It is also used in detecting mutations.
- Protein is not the target of PCR. Hence, plays no role in its purification.

120. The amount of nutrients, such as carbon, nitrogen, phosphorus and calcium present in the soil at any given time, is referred as :

- (1) Climax
- (2) Climax community
- (3) Standing state
- (4) Standing crop

Answer (3)

Sol. • Amount of all the inorganic substances or nutrients, such as carbon, nitrogen, phosphorus and calcium present in soil at any given time, is referred as standing state.

- Amount of living material present in different trophic levels at a given time, is referred as standing crop.
- Climax community is the last community in biotic succession which is relatively stable and is in near equilibrium with the environment of that area.

121. The term used for transfer of pollen grains from anthers of one plant to stigma of a different plant which, during pollination, brings genetically different types of pollen grains to stigma, is :

- (1) Xenogamy
- (2) Geitonogamy
- (3) Chasmogamy
- (4) Cleistogamy

Answer (1)

Sol. • Xenogamy refers to the transfer to pollen grains from anthers of one plant to stigma of a different plant which during pollination, brings genetically different types of pollen grains to stigma.

- Cleistogamy is a condition in which flower does not open.
- Geitonogamy refers to the transfer of pollen grain from anther to stigma of another flower of the same plant.
- Chasmogamy is a condition in which flowers remain open.

122. The production of gametes by the parents, formation of zygotes, the F_1 and F_2 plants, can be understood from a diagram called :

- (1) Bullet square
- (2) Punch square
- (3) Punnett square
- (4) Net square

Answer (3)

Sol. The production of gametes (n) by the parents ($2n$), the formation of the zygote ($2n$), the F_1 and F_2 plants can be understood from a diagram called Punnett square.

123. In the equation $GPP - R = NPP$

R represents :

- (1) Radiant energy
- (2) Retardation factor
- (3) Environmental factor
- (4) Respiration losses

Answer (4)

Sol. In the equation,

$$GPP - R = NPP$$

R refers to respiratory loss

GPP is gross primary productivity

NPP is net primary productivity

124. DNA strands on a gel stained with ethidium bromide when viewed under UV radiation, appear as

- (1) Yellow bands
- (2) Bright orange bands
- (3) Dark red bands
- (4) Bright blue bands

Answer (2)

Sol. After the bands are stained, they are viewed in UV light. The bands appear bright orange in colour. Ethidium bromide is the intercalating agent that stacks in between the nitrogenous bases.

125. The factor that leads to Founder effect in a population is :

- (1) Natural selection
- (2) Genetic recombination
- (3) Mutation
- (4) Genetic drift

Answer (4)

Sol. • Change in gene frequency in a small population by chance is known as genetic drift. Genetic drift has two ramifications, one is bottle neck effect and another is founder's effect.

- When accidentally a few individuals are dispersed and act as founders of a new isolated population, founder's effect is said to be observed.
- Crossing over which occurs during gamete formation results in genetic recombination.
- Mutations are random and directionless.

126. When the centromere is situated in the middle of two equal arms of chromosomes, the chromosome is referred as :

- (1) Metacentric
- (2) Telocentric
- (3) Sub-metacentric
- (4) Acrocentric

Answer (1)

Sol. When the centromere is situated in the middle of two equal arms of chromosomes, the chromosome is referred as Metacentric.

When the centromere is present slightly away from the middle, it is called sub-metacentric chromosome.

When the centromere is present very close to one end of the chromosome, it is called acrocentric chromosome.

When the centromere is present at terminal position, the chromosome is called telocentric.

127. Genera like *Selaginella* and *Salvinia* produce two kinds of spores. Such plants are known as:

- (1) Homosorus
- (2) Heterosorus
- (3) Homosporous
- (4) Heterosporous

Answer (4)

Sol. Plants like *Selaginella* and *Salvinia* produce two kinds of spore *i.e.*, microspores and macrospores. They are known as heterosporous.

Most of the pteridophytes produce single type of spores and are called homosporous

Sorus are brownish or yellowish cluster of spore-producing structures located on the lower surface of fern leaves.

128. Match **List-I** with **List-II**.

List-I		List-II	
(a)	Cohesion	(i)	More attraction in liquid phase
(b)	Adhesion	(ii)	Mutual attraction among water molecules
(c)	Surface tension	(iii)	Water loss in liquid phase
(d)	Guttation	(iv)	Attraction towards polar surfaces

Choose the **correct** answer from the options given below.

- | | | | |
|------------|------------|------------|------------|
| (a) | (b) | (c) | (d) |
| (1) (ii) | (iv) | (i) | (iii) |
| (2) (iv) | (iii) | (ii) | (i) |
| (3) (iii) | (i) | (iv) | (ii) |
| (4) (ii) | (i) | (iv) | (iii) |

Answer (1)

Sol. (a) Cohesion is mutual attraction among water molecules.

(b) Adhesion is attraction towards polar surfaces.

(c) Surface tension explains water molecules are more attracted in liquid phase than gaseous phase.

(d) Guttation is loss of water in liquid form from the leaf margins.

129. Gemmae are present in

- (1) Mosses
- (2) Pteridophytes
- (3) Some Gymnosperms
- (4) Some Liverworts

Answer (4)

Sol. • Gemmae are green, multicellular asexual buds that are produced by some liverworts like *Marchantia*.

- Mosses reproduce vegetatively by fragmentation and budding of protonema.
- Pteridophytes and Gymnosperms normally do not reproduce asexually

130. Which of the following algae produce Carrageen?

- (1) Green algae
- (2) Brown algae
- (3) Red algae
- (4) Blue-green algae

Answer (3)

Sol. • The cell wall of red algae is composed of agar, carrageen and funori along with cellulose.

- In brown algae cell wall contains algin while in green algae it is composed of cellulose and pectin.
- In blue green algae cell wall is composed of mucopeptides.

131. Complete the flow chart on central dogma.

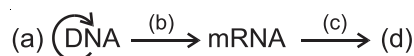

- (1) (a)-Replication; (b)-Transcription; (c)-Transduction; (d)-Protein
- (2) (a)-Translation; (b)-Replication; (c)-Transcription;(d)-Transduction
- (3) (a)-Replication; (b)-Transcription; (c)-Translation; (d)-Protein
- (4) (a)-Transduction; (b)-Translation; (c)-Replication; (d)-Protein

Answer (3)

- Sol.**
- Formation of DNA from DNA is replication.
 - Formation of mRNA from DNA is called Transcription.
 - Formation of protein from mRNA is called Translation.
 - So, (a) is Replication
(b) is Transcription
(c) is Translation
(d) is Protein
 - Transduction is transfer of genetic material from one bacterium to another with the help of virus or a bacteriophage.

132. Which of the following statements is **not** correct?

- (1) Pyramid of biomass in sea is generally inverted.
- (2) Pyramid of biomass in sea is generally upright.
- (3) Pyramid of energy is always upright.
- (4) Pyramid of numbers in a grassland ecosystem is upright.

Answer (2)

Sol. Pyramid of biomass in sea is inverted. For example, biomass of zooplanktons is higher than that of phytoplanktons as life span of former is longer and the latter multiply much faster though having shorter life span.

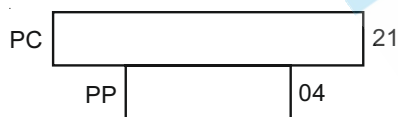

Small standing crop of phytoplanktons supports large standing crop of zooplankton

133. In spite of interspecific competition in nature, which mechanism the competing species might have evolved for their survival?
- (1) Resource partitioning
 - (2) Competitive release
 - (3) Mutualism
 - (4) Predation

Answer (1)

- Sol.**
- In spite of interspecific competition the competing species may co-exist by doing resource partitioning.
 - In mutualism two organisms are equally benefitted.
 - In predation one organism (Predator) eats the another one (Prey).
 - In competition release there occurs dramatical increase in population of a less distributed species when its superior competitor is removed.

134. Match **List-I** with **List-II**.

List-I		List-II	
(a)	Lenticels	(i)	Phellogen
(b)	Cork cambium	(ii)	Suberin deposition
(c)	Secondary cortex	(iii)	Exchange of gases
(d)	Cork	(iv)	Phelloderm

Choose the **correct** answer from the options given below.

- | | (a) | (b) | (c) | (d) |
|-----|-------|-------|-------|-------|
| (1) | (iv) | (i) | (iii) | (ii) |
| (2) | (iii) | (i) | (iv) | (ii) |
| (3) | (ii) | (iii) | (iv) | (i) |
| (4) | (iv) | (ii) | (i) | (iii) |

Answer (2)

- Sol.**
- Lenticels are meant for exchange of gases.
 - Phellogen is also known as cork cambium.
 - Phelloderm is also called secondary cortex because it is the cortex that develops during secondary growth.
 - Cork has deposition of suberin in their cell walls when they get mature.

135. Match **List-I** with **List-II**.

	List - I		List - II
(a)	Cells with active cell division capacity	(i)	Vascular tissues
(b)	Tissue having all cells similar in structure and function	(ii)	Meristematic tissue
(c)	Tissue having different types of cells	(iii)	Sclereids
(d)	Dead cells with highly thickened walls and narrow lumen	(iv)	Simple tissue

Select the **correct** answer from the options given below.

- | | | | | |
|-----|-------|-------|-------|-------|
| | (a) | (b) | (c) | (d) |
| (1) | (ii) | (iv) | (i) | (iii) |
| (2) | (iv) | (iii) | (ii) | (i) |
| (3) | (i) | (ii) | (iii) | (iv) |
| (4) | (iii) | (ii) | (iv) | (i) |

Answer (1)

- Sol.** (a) Meristematic tissues are those tissues which have cells with active cell division capacity.
- (b) Simple tissues are those tissues which have all the cells similar in structure and function.
- (c) Vascular tissues are complex permanent tissues hence they have different types of cells.
- (d) Sclereids are sclerenchymatous cells which are dead with highly thickened walls and narrow lumen.

SECTION - B

136. Match **Column-I** with **Column-II**.

	Column-I		Column-II
(a)	<i>Nitrococcus</i>	(i)	Denitrification
(b)	<i>Rhizobium</i>	(ii)	Conversion of ammonia to nitrite
(c)	<i>Thiobacillus</i>	(iii)	Conversion of nitrite to nitrate
(d)	<i>Nitrobacter</i>	(iv)	Conversion of atmospheric nitrogen to ammonia

Choose the **correct** answer from options given below.

- | | | | | |
|-----|-------|-------|-------|-------|
| | (a) | (b) | (c) | (d) |
| (1) | (ii) | (iv) | (i) | (iii) |
| (2) | (i) | (ii) | (iii) | (iv) |
| (3) | (iii) | (i) | (iv) | (ii) |
| (4) | (iv) | (iii) | (ii) | (i) |

Answer (1)

- Sol.** • Nitrogen fixation is conversion of atmospheric N_2 to NH_3 (ammonia). It is carried out by N_2 fixers such as *Rhizobium*.
- NH_3 is converted to NO_2^- (nitrite) by nitrifying bacteria such as *Nitrococcus*.

- Then NO_2^- is converted to NO_3^- (nitrate) by nitrifying bacteria called *Nitrobacter*.
- Thiobacillus* carries out denitrification, a process where NO_2^- / NO_3^- is converted to N_2 .

137. Match **List-I** with **List-II**.

List-I		List-II	
(a)	S phase	(i)	Proteins are synthesized
(b)	G_2 phase	(ii)	Inactive phase
(c)	Quiescent stage	(iii)	Interval between mitosis and initiation of DNA replication
(d)	G_1 phase	(iv)	DNA replication

Choose the **correct** answer from the options given below.

- | | | | | |
|-----|-------|------|-------|-------|
| | (a) | (b) | (c) | (d) |
| (1) | (iii) | (ii) | (i) | (iv) |
| (2) | (iv) | (ii) | (iii) | (i) |
| (3) | (iv) | (i) | (ii) | (iii) |
| (4) | (ii) | (iv) | (iii) | (i) |

Answer (3)

- Sol.** • In S phase DNA replication takes place.
- In G_2 phase there is synthesis of proteins, RNA etc.
 - Quiescent stage is inactive stage of cell cycle but cells remain metabolically active in this stage.
 - G_1 phase is the interval between mitosis and initiation of DNA replication.

138. Match **Column-I** with **Column-II**

Column-I	Column-II
(a) $\% \text{♀} K_{(5)} C_{1+2} + {}_{(2)}A_{(9)+1} \underline{G}_1$	(i) Brassicaceae
(b) $\text{♀} \text{♂} K_{(5)} \overline{C_{(5)} A_5} \underline{G}_{(2)}$	(ii) Liliaceae
(c) $\text{♀} \text{♂} \overline{P_{(3+3)} A_{3+3}} \underline{G}_{(3)}$	(iii) Fabaceae
(d) $\text{♀} \text{♂} K_{2+2} C_4 A_{2-4} \underline{G}_{(2)}$	(iv) Solanaceae

Select the **correct** answer from the options given below.

- | | | | | |
|-----|------------|------------|------------|------------|
| | (a) | (b) | (c) | (d) |
| (1) | (iii) | (iv) | (ii) | (i) |
| (2) | (i) | (ii) | (iii) | (iv) |
| (3) | (ii) | (iii) | (iv) | (i) |
| (4) | (iv) | (ii) | (i) | (iii) |

Answer (1)

Sol. The floral formula of

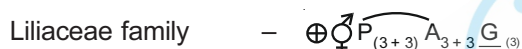
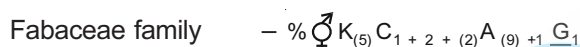
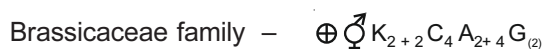

So a(iii), b(iv), c(ii), d(i) is correct matching.

139. Which of the following statements is **incorrect**?

- (1) During aerobic respiration, role of oxygen is limited to the terminal stage
- (2) In ETC (Electron Transport Chain), one molecule of NADH + H⁺ gives rise to 2 ATP molecules, and one FADH₂ gives rise to 3 ATP molecules
- (3) ATP is synthesized through complex V
- (4) Oxidation-reduction reactions produce proton gradient in respiration

Answer (2)

Sol. • During respiration, process of ATP synthesis is explained by chemiosmotic model. It says that a proton gradient is required for ATP synthesis that is established by oxidation-reduction reactions.

- In ETC, one NADH + H⁺ produces 3 ATP while one FADH₂ produces 2 ATP molecules.
- ATP is synthesised via complex V.
- In ETS, oxygen acts as terminal electron acceptor.

140. In the exponential growth equation $N_t = N_0 e^{rt}$, e represents

- (1) The base of number logarithms
- (2) The base of exponential logarithms
- (3) The base of natural logarithms
- (4) The base of geometric logarithms

Answer (3)

Sol. In the exponential growth equation $N_t = N_0 e^{rt}$,

e represents the base of natural logarithms

N_t = Population density after time t

N_0 = Population density at time zero

r = Intrinsic rate of natural increase called biotic potential.

141. Which of the following statements is **incorrect**?

- (1) Both ATP and NADPH + H⁺ are synthesized during non-cyclic photophosphorylation
- (2) Stroma lamellae have PS I only and lack NADP reductase
- (3) Grana lamellae have both PS I and PS II
- (4) Cyclic photophosphorylation involves both PS I and PS II

Answer (4)

Sol. • Cyclic photophosphorylation involves only PS I. Both PS I and PS II are involved in non-cyclic photophosphorylation where both ATP and NADPH + H⁺ are synthesized.

- Both PS I and PS II are found on grana lamellae whereas stroma lamellae have PS I only and lack NADP reductase.

142. What is the role of RNA polymerase III in the process of transcription in eukaryotes?

- (1) Transcribes rRNAs (28S, 18S and 5.8S)
- (2) Transcribes tRNA, 5s rRNA and snRNA
- (3) Transcribes precursor of mRNA
- (4) Transcribes only snRNAs

Answer (2)

Sol. • RNA polymerase III transcribes tRNA, ScRNA, 5S rRNA and SnRNA.

- RNA polymerase I transcribes 5.8S, 18S and 28S rRNA.
- RNA polymerase II transcribes hnRNA which is precursor of mRNA

143. Now a days it is possible to detect the mutated gene causing cancer by allowing radioactive probe to hybridise its complimentary DNA in a clone of cells, followed by its detection using autoradiography because :

- (1) mutated gene partially appears on a photographic film
- (2) mutated gene completely and clearly appears on a photographic film
- (3) mutated gene does not appear on a photographic film as the probe has no complementarity with it
- (4) mutated gene does not appear on photographic film as the probe has complementarity with it

Answer (3)

Sol. Autoradiography allows the detection/localisation of radioactive isotope within a biological sample.

Probe is a radiolabelled ss DNA or ss RNA depending on the technique. To identify the mutated gene probe is allowed to hybridise to its complementary DNA in a clone of cells followed by detection using autoradiography. The mutated gene will not appear on the photographic film, because the probe does not have complementarity with the mutated gene.

144. Which of the following statements is **correct** ?

- (1) Fusion of two cells is called Karyogamy
- (2) Fusion of protoplasts between two motile on non-motile gametes is called plasmogamy
- (3) Organisms that depend on living plants are called saprophytes
- (4) Some of the organisms can fix atmospheric nitrogen in specialized cells called sheath cells

Answer (2)

Sol. • In some blue-green algae specialised cells called heterocyst fixes atmospheric nitrogen into ammonia.

- Fusion of two nuclei is called Karyogamy.
- Organisms that depend on living plants are parasites, saprophytes grow on dead material.
- Fusion of protoplasts of two cells is called plasmogamy.

145. Match **List-I** with **List-II**.

List-I	List-II
(a) Protein	(i) C = C double bonds
(b) Unsaturated fatty acid	(ii) Phosphodiester bonds
(c) Nucleic acid	(iii) Glycosidic bonds
(d) Polysaccharide	(iv) Peptide bonds

Choose the **correct** answer from the options given below.

- | | | | | |
|-----|------------|------------|------------|------------|
| | (a) | (b) | (c) | (d) |
| (1) | (iv) | (i) | (ii) | (iii) |
| (2) | (i) | (iv) | (iii) | (ii) |
| (3) | (ii) | (i) | (iv) | (iii) |
| (4) | (iv) | (iii) | (i) | (ii) |

Answer (1)

- Sol.** • In a polypeptide or a protein, amino acids are linked by a peptide bond which is formed when the carboxyl (-COOH) group of one amino acid reacts with amino (-NH₂) group of the next amino acid with the elimination of a water moiety.
- Unsaturated fatty acids are with one or more C = C double bonds.
 - In nucleic acids, a phosphate moiety links the 3'-carbon of one sugar of one nucleotide to the 5'-carbon of the sugar of the succeeding nucleotide. The bond between the phosphate and hydroxyl group is an ester bond. As there is one such ester bond on either side, it is called phosphodiester bond.
 - In a polysaccharide, the individual monosaccharides are linked by a glycosidic bond.

146. Select the **correct** pair.

- (1) Large colorless empty cells in the epidermis of grass leaves - Subsidiary cells
- (2) In dicot leaves, vascular bundles are surrounded by large thick-walled cells - Conjunctive tissue
- (3) Cells of medullary rays that form part of cambial ring - Interfascicular cambium
- (4) Loose parenchyma cells rupturing the epidermis and forming a lens shaped opening in bark - Spongy parenchyma

Answer (3)

- Sol.** • When the cells of medullary rays differentiated, they give rise to the new cambium called interfascicular cambium.
- Loose parenchyma cells rupturing the epidermis and forming a lens-shaped opening in bark are called complementary cells.
 - Large colourless empty cells in the epidermis of grass leaves are called bulliform cells.
 - In dicot leaf, vascular bundles are surrounded by large thick walled cells called bundle sheath cells.

147. DNA fingerprinting involves identifying differences in some specific regions in DNA sequence, called as
- (1) Satellite DNA (2) Repetitive DNA
(3) Single nucleotides (4) Polymorphic DNA

Answer (2)

- Sol.** • DNA fingerprinting involves identifying differences in some specific regions in DNA sequence called as repetitive DNA.
- The basis of DNA fingerprinting is VNTR (a satellite DNA as probe that show very high degree of polymorphism)
 - Polymorphism is the variation at genetic level. Allelic sequence variation has traditionally been described as a DNA polymorphism.
148. Plasmid pBR322 has PstI restriction enzyme site within gene *amp^R* that confers ampicillin resistance. If this enzyme is used for inserting a gene for β -galactoside production and the recombinant plasmid is inserted in an *E.coli* strain
- (1) It will not be able to confer ampicillin resistance to the host cell
(2) The transformed cells will have the ability to resist ampicillin as well as produce β -galactoside
(3) It will lead to lysis of host cell
(4) It will be able to produce a novel protein with dual ability

Answer (1)

- Sol.** pBR322 is a commonly used cloning vector. When the gene for β -galactoside is inserted in the ampicillin resistance gene by using *Pst* I, the recombinant *E.coli* will lose ampicillin resistance due

to insertional inactivation of the antibiotic resistance gene.

The host (recombinant) cell will produce β -galactoside which is not a novel protein **nor** does it have dual ability.

The transformed cells cannot resist ampicillin as they have lost ampicillin resistance.

A recombinant *E. coli* is produced and the host cell will not undergo lysis due to insertion of β -galactoside gene.

149. Identify the **correct** statement.

- (1) In capping, methyl guanosine triphosphate is added to the 3' end of hnRNA
(2) RNA polymerase binds with Rho factor to terminate the process of transcription in bacteria
(3) The coding strand in a transcription unit is copied to an mRNA
(4) Split gene arrangement is characteristic of prokaryotes

Answer (2)

- Sol.** • Split gene arrangement is characteristic of eukaryotes.
- In capping 5-methyl guanosine triphosphate is added at 5' end of hnRNA.
 - At 3' end poly-A tail is added.
 - The non coding or template strand is copied to an mRNA. RNA polymerase associate with ρ factor (Rho factor) and it alters the specificity of the RNA polymerase to terminate the processes.

150. In some members of which of the following pairs of families, pollen grains retain their viability for months after release?
- (1) Poaceae ; Rosaceae
(2) Poaceae ; Leguminosae
(3) Poaceae ; Solanaceae
(4) Rosaceae ; Leguminosae

Answer (4)

- Sol.** • In members of some plant families like Solanaceae, Rosaceae and Leguminosae the pollen grains retain their viability for several months.
- In cereals (Poaceae) pollen grains retain viability for around 30 minutes.

ZOOLOGY

SECTION - A

151. Which of the following characteristics is **incorrect** with respect to cockroach?

- (1) A ring of gastric caeca is present at the junction of midgut and hind gut
- (2) Hypopharynx lies within the cavity enclosed by the mouth parts
- (3) In females, 7th-9th sterna together form a genital pouch
- (4) 10th abdominal segment in both sexes, bears a pair of anal cerci

Answer (1)

- Sol.**
- Option (1) is incorrect because a ring of gastric caecae is present at the junction of foregut and midgut. At the junction of midgut and hindgut, malpighian tubules are present.
 - Hypopharynx lies within the cavity enclosed by mouthparts.
 - In female cockroach, the 7th sternum is boat shaped and together with the 8th and 9th sterna forms a genital pouch.
 - 10th abdominal segment in both sexes, bears a pair of anal cerci and 9th sternum only in male cockroach, bears a pair of chitinous anal style.

152. Match List - I with List - II

List -I		List -II	
(a)	Metamerism	(i)	Coelenterata
(b)	Canal system	(ii)	Ctenophora
(c)	Comb plates	(iii)	Annelida
(d)	Cnidoblasts	(iv)	Porifera

Choose the correct answer from the options given below.

- | | | | | |
|-----|------------|------------|------------|------------|
| | (a) | (b) | (c) | (d) |
| (1) | (iv) | (iii) | (i) | (ii) |
| (2) | (iii) | (iv) | (i) | (ii) |
| (3) | (iii) | (iv) | (ii) | (i) |
| (4) | (iv) | (i) | (ii) | (iii) |

Answer (3)

Sol. Metamerism is commonly seen in the members of phylum Annelida where the body is externally and internally divided into segments with a serial repetition of atleast some organs.

Water canal system is present in the members of phylum Porifera.

The body of ctenophores bears 8 external rows of ciliated comb plates which help in locomotion.

Cnidoblasts or cnidocytes are characteristic feature of cnidarians (coelentrata).

153. A specific recognition sequence identified by endonucleases to make cuts at specific positions within the DNA is:

- (1) Degenerate primer sequence
- (2) Okazaki sequences
- (3) Palindromic Nucleotide sequences
- (4) Poly(A) tail sequences

Answer (3)

Sol. Each restriction endonuclease recognizes a specific palondromic nucleotide sequence in the DNA. Once it finds its specific recognition sequence it bind to DNA and cuts each of the two strands of DNA.

- During post transcriptional modification in eukaryotes, poly(A) tail (200–300 adenylate residues) are added at 3' end of hnRNA.
- During DNA replication Okazaki fragments are synthesized discontinuously and joined by DNA ligase.
- A PCR primer sequence is termed degenerate if some of its position have several possible bases.

154. The fruit fly has 8 chromosomes (2n) in each cell. During interphase of Mitosis if the number of chromosomes at G₁ phase is 8, what would be the number of chromosomes after S phase?

- | | |
|-------|--------|
| (1) 8 | (2) 16 |
| (3) 4 | (4) 32 |

Answer (1)

Sol. In S phase there is duplication of DNA. So amount of DNA increases but not the chromosome number.
So, if the number of chromosomes at G_1 phase is 8 in fruit fly then the number of chromosomes will be same in S phase that is 8 only.

155. Persons with 'AB' blood group are called as "Universal recipients". This is due to :

- (1) Absence of antigens A and B on the surface of RBCs
- (2) Absence of antigens A and B in plasma
- (3) Presence of antibodies, anti-A and anti-B, on RBCs
- (4) Absence of antibodies, anti-A and anti-B, in plasma

Answer (4)

Sol. Option (4) is correct because persons with 'AB' blood group contain antigens 'A' and 'B' but lack antibodies anti-A and anti-B in plasma. So, persons with 'AB' blood group can accept blood from persons with AB as well as the other groups of blood due to lack of antibodies in their blood. Therefore, such persons are called "Universal recipients".

156. Which of the following statements wrongly represents the nature of smooth muscle?

- (1) These muscle have no striations
- (2) They are involuntary muscles
- (3) Communication among the cells is performed by intercalated discs
- (4) These muscles are present in the wall of blood vessels

Answer (3)

Sol. • Option (3) is incorrect because intercalated discs are found only in cardiac muscle tissue.

- Smooth muscle fibres are non-striated and involuntary in nature and are present in the wall of blood vessels, uterus, gall bladder, alimentary canal etc.

157. Which one of the following belongs to the family Muscidae?

- (1) Fire fly
- (2) Grasshopper
- (3) Cockroach
- (4) House fly

Answer (4)

Sol. • Option (4) is correct because housefly belongs to the family Muscidae, class Insecta and phylum Arthropoda.

- Fire flies are placed in family Lampyridae of class insecta.
- Grasshopper is also an insect placed in family Acrididae.
- Cockroach is also an insect placed in family Blattidae.

158. Which is the "Only enzyme" that has "Capability" to catalyse Initiation, Elongation and Termination in the process of transcription in prokaryotes?

- (1) DNA dependent DNA polymerase
- (2) DNA dependent RNA polymerase
- (3) DNA Ligase
- (4) DNase

Answer (2)

Sol. In prokaryotes, the DNA dependent RNA polymerase is a holoenzyme that is made of polypeptides ($\alpha_2\beta\beta'\omega$) σ . It is responsible for initiation, elongation and termination during transcription.

DNase degrades DNA.

DNA dependent DNA polymerase is involved in replication of DNA.

DNA ligase joins the discontinuously synthesised fragments of DNA.

159. Which of the following RNAs is not required for the synthesis of protein?

- (1) mRNA
- (2) tRNA
- (3) rRNA
- (4) siRNA

Answer (4)

Sol. siRNA are small interfering RNA also called silencing RNA. It is a class of double-stranded RNA, non-coding RNA molecules.

mRNA is messenger RNA that carries genetic information provided by DNA.

tRNA carries amino acids to the mRNA during translation.

rRNA is structural RNA that forms ribosomes which are involved in translation.

160. For effective treatment of the disease, early diagnosis and understanding its pathophysiology is very important. Which of the following molecular diagnostic techniques is very useful for early detection?

- (1) Western Blotting Technique
- (2) Southern Blotting Technique
- (3) ELISA Technique
- (4) Hybridization Technique

Answer (2/3*)

Sol. • ELISA can be used for early detection of an infection either by detecting the presence of pathogenic antigen or by detecting the antibodies synthesized against the pathogen.

- Option (2) Southern blotting is used to detect a specific DNA sequence in the given sample and can be detected prior to antibody formation. One can detect presence of pathogenic DNA/RNA.
- In hybridization technique a ssDNA/ssRNA tagged with a radioactive molecule (probe) is allowed to hybridize its complementary DNA in a clone of cells followed by detection using autoradiography. It is used to find a mutated gene.
- Western blotting technique is used to detect a specific protein molecule among a mixture of proteins.

161. Erythropoietin hormone which stimulates R.B.C. formation is produced by:

- (1) Alpha cells of pancreas
- (2) The cells of rostral adenohypophysis
- (3) The cells of bone marrow
- (4) Juxtaglomerular cells of the kidney

Answer (4)

Sol. • Option (4) is correct because Juxtaglomerular cells of kidney secrete erythropoietin hormone which stimulates RBC formation.

- Alpha cells of pancreas produce hormone glucagon.
- The cells of rostral adenohypophysis synthesizes hormones of anterior lobe of pituitary.
- The cells of bone marrow are responsible for formation of formed elements.

162. The partial pressures (in mm Hg) of oxygen (O₂) and carbon dioxide (CO₂) at alveoli (the site of diffusion) are:

- (1) pO₂ = 104 and pCO₂ = 40
- (2) pO₂ = 40 and pCO₂ = 45
- (3) pO₂ = 95 and pCO₂ = 40
- (4) pO₂ = 159 and pCO₂ = 0.3

Answer (1)

Sol. • Option (1) is correct because pO₂ in alveoli is 104 mm Hg and pCO₂ in alveoli is 40 mmHg.

- In atmosphere, pO₂ is 159 mm Hg and pCO₂ is 0.3 mm Hg.
- In deoxygenated blood, pO₂ is 40 mmHg and pCO₂ is 45 mmHg.
- In oxygenated blood, pO₂ is 95 mmHg and pCO₂ is 40 mmHg.

163. In a cross between a male and female, both heterozygous for sickle cell anaemia gene, what percentage of the progeny will be diseased?

- (1) 50%
- (2) 75%
- (3) 25%
- (4) 100%

Answer (3)

Sol. According to given question;

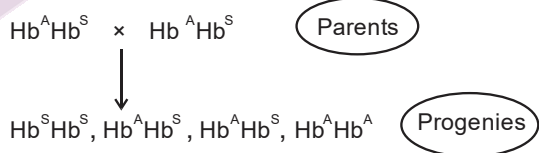

Total number of affected progenies = 1

∴ Percentage of diseased/affected progenies

$$= \frac{1}{4} \times 100 = 25\%$$

164. Which stage of meiotic prophase shows terminalisation of chiasmata as its distinctive feature?

- (1) Leptotene
- (2) Zygotene
- (3) Diakinesis
- (4) Pachytene

Answer (3)

- Sol.**
- In meiosis I, chiasmata (X shaped structure) is formed in diplotene stage while it terminalise in diakinesis stage.
 - Bivalents are formed in zygotene stage and crossing over takes place in pachytene stage.
 - Compaction of chromosomal material occurs in leptotene stage.

165. Which one of the following organisms bears hollow and pneumatic long bones?

- (1) *Neophron*
- (2) *Hemidactylus*
- (3) *Macropus*
- (4) *Ornithorhynchus*

Answer (1)

- Sol.**
- Hollow and pneumatic long bones are present in animals that belong to class Aves e.g., *Neophron* (vulture).
 - *Ornithorhynchus* (Platypus) and *Macropus* (Kangaroo) belong to class Mammalia.
 - *Hemidactylus* (Wall lizard) is a member of class Reptilia.

166. Match the following:

List-I		List-II	
(a)	<i>Physalia</i>	(i)	Pearl oyster
(b)	<i>Limulus</i>	(ii)	Portuguese Man of War
(c)	<i>Ancylostoma</i>	(iii)	Living fossil
(d)	<i>Pinctada</i>	(iv)	Hookworm

Choose the **correct** answer from the options given below.

- | | (a) | (b) | (c) | (d) |
|-----|------|-------|-------|------|
| (1) | (ii) | (iii) | (i) | (iv) |
| (2) | (iv) | (i) | (iii) | (ii) |
| (3) | (ii) | (iii) | (iv) | (i) |
| (4) | (i) | (iv) | (iii) | (ii) |

Answer (3)

- Sol.** • Option (3) is correct because *Physalia* is commonly known as Portuguese man of war.

- *Limulus* is considered as a living fossil and commonly known as king crab.
- *Ancylostoma* is a roundworm and commonly known as hookworm.
- *Pinctada* is commonly known as pearl oyster, included in phylum Mollusca.

167. Which of the following is not an objective of Biofortification in crops?

- (1) Improve protein content
- (2) Improve resistance to diseases
- (3) Improve vitamin content
- (4) Improve micronutrient and mineral content

Answer (2)

Sol. Biofortification improves vitamin content, protein content and micronutrient and mineral content.

It does not create resistance in plants against diseases.

168. If Adenine makes 30% of the DNA molecule, what will be the percentage of Thymine, Guanine and Cytosine in it?

- (1) T : 20 ; G : 30 ; C : 20
- (2) T : 20 ; G : 20 ; C : 30
- (3) T : 30 ; G : 20 ; C : 20
- (4) T : 20 ; G : 25 ; C : 25

Answer (3)

Sol. According to Chargaff's rule, for a double stranded DNA,

$$[A] = [T],$$

$$\therefore [A] = 30\% \Rightarrow [T] = 30\%$$

$$\text{Since } [C] = [G]$$

$$\therefore 100 - [A + T]$$

$$= 100 - [30 + 30]$$

$$= 100 - 60 = 40\%$$

and $C = G = 20\%$ each

$$\therefore [A] = 30\%$$

$$[T] = 30\%$$

$$[G] = 20\%$$

$$[C] = 20\%$$

169. Match List-I with List-II.

List-I		List-II	
(a)	Vaults	(i)	Entry of sperm through Cervix is blocked
(b)	IUDs	(ii)	Removal of Vas deferens
(c)	Vasectomy	(iii)	Phagocytosis of sperms within the Uterus
(d)	Tubectomy	(iv)	Removal of fallopian tube

Choose the **correct** answer from the option given below

- | | (a) | (b) | (c) | (d) |
|-----|-------|-------|-------|-------|
| (1) | (iv) | (ii) | (i) | (iii) |
| (2) | (i) | (iii) | (ii) | (iv) |
| (3) | (ii) | (iv) | (iii) | (i) |
| (4) | (iii) | (i) | (iv) | (ii) |

Answer (2)

- Sol.** • Diaphragms, cervical caps and vaults are barrier methods of contraception for female which works by blocking the entry of sperms through the cervix.
- IUDs increase phagocytosis of sperms within the uterus.
 - Vasectomy is a surgical method of contraception in males in which a small part of the vas deferens is removed or tied up through a small incision on the scrotum.
 - Tubectomy is a surgical method of contraception in females where a small part of the fallopian tube is removed or tied up through a small incision in the abdomen or through vagina.

170. Venereal diseases can spread through :

- Using sterile needles
- Transfusion of blood from infected person
- Infected mother to foetus
- Kissing
- Inheritance

Choose the **correct** answer from the option given below

- (a), (b) and (c) only
- (b), (c) and (d) only
- (b) and (c) only
- (a) and (c) only

Answer (3)

- Sol.** • Venereal diseases or sexually transmitted diseases or infections are transmitted by sharing of infected needles, surgical instruments with infected person, transfusion of blood or from an infected mother to foetus.
- Venereal diseases are not transmitted through kissing or inheritance.

171. The centriole undergoes duplication during:

- S-phase
- Prophase
- Metaphase
- G₂ phase

Answer (1)

Sol. During S phase of cell cycle replication of DNA takes place. In animal cells during S phase, centriole duplicates in the cytoplasm.

In G₂ phase there is duplication of mitochondria, chloroplast and Golgi bodies. Tubulin protein is also synthesized during this phase.

During prophase, condensation of chromatin starts.

During metaphase, chromosomes get aligned at equator to form metaphasic plate.

172. Receptors for sperm binding in mammals are present on :

- Corona radiata
- Vitelline membrane
- Perivitelline space
- Zona pellucida

Answer (4)

Sol. • Option (4) is correct because zona pellucida has receptors for sperm binding (ZP3 receptors) in mammals.

- Corona radiata is a layer of radially arranged cells of membrana granulosa.
- Perivitelline space is present in between vitelline membrane and zona pellucida.

173. Dobson units are used to measure thickness of:

- CFCs
- Stratosphere
- Ozone
- Troposphere

Answer (3)

Sol. The thickness of the ozone in a column of air from the ground to the top of atmosphere is measured in term of Dobson unit (1 DU = 1ppb).

The lowermost layer of atmosphere is called troposphere.

CFCs are ozone depleting substances. Ozone found in upper part of atmosphere (the stratosphere) is called good ozone.

174. Match List-I with List-II

List-I		List-II	
(a)	<i>Aspergillus niger</i>	(i)	Acetic Acid
(b)	<i>Acetobacter aceti</i>	(ii)	Lactic Acid
(c)	<i>Clostridium butylicum</i>	(iii)	Citric Acid
(d)	<i>Lactobacillus</i>	(iv)	Butyric Acid

Choose the **correct** answer from the options given below

- | | (a) | (b) | (c) | (d) |
|-----|-------|-------|-------|-------|
| (1) | (iii) | (i) | (iv) | (ii) |
| (2) | (i) | (ii) | (iii) | (iv) |
| (3) | (ii) | (iii) | (i) | (iv) |
| (4) | (iv) | (ii) | (i) | (iii) |

Answer (1)

Sol. *Aspergillus niger* is involved in production of citric acid. *Acetobacter aceti* is involved in production of acetic acid. *Clostridium butylicum* is involved in production of butyric acid whereas *Lactobacillus* is involved in the production of lactic acid.

So a(iii), b(i), c(iv), d(ii) is correct matching.

175. Identify the **incorrect** pair

- | | | |
|---------------|---|----------------|
| (1) Alkaloids | – | Codeine |
| (2) Toxin | – | Abrin |
| (3) Lectins | – | Concanavalin A |
| (4) Drugs | – | Ricin |

Answer (4)

Sol. • Option (4) is incorrect because ricin is a toxin obtained from *Ricinus* plant. Vinblastin and curcumin are drugs.

- Morphine and codeine are alkaloids.
- Abrin is also a toxin obtained by plant *Abrus*.
- Concanavalin A is a lectin.

176. The organelles that are included in the endomembrane system are

- | |
|--|
| (1) Endoplasmic reticulum, Mitochondria, Ribosomes and Lysosomes |
| (2) Endoplasmic reticulum, Golgi complex, Lysosomes and Vacuoles |

- | |
|--|
| (3) Golgi complex, Mitochondria, Ribosomes and Lysosomes |
| (4) Golgi complex, Endoplasmic reticulum, Mitochondria and Lysosomes |

Answer (2)

Sol. • Endomembrane system consist of endoplasmic reticulum, Golgi complex, vacuoles and lysosomes.

- Mitochondria is semi-autonomous cell organelle.
- Ribosome is non-membranous cell organelle.

177. Chronic auto immune disorder affecting neuro muscular junction leading to fatigue, weakening and paralysis of skeletal muscle is called as:

- | | |
|-----------------------|------------------------|
| (1) Arthritis | (2) Muscular dystrophy |
| (3) Myasthenia gravis | (4) Gout |

Answer (3)

Sol. • Option (3) is correct because myasthenia gravis is a chronic auto immune disorder affecting neuromuscular junction leading to fatigue, weakening and paralysis of skeletal muscle.

- Gout is caused due to deposition of uric acid crystals in joints leading to its inflammation.
- Inflammation of joints is commonly known as arthritis.
- Muscular dystrophy is a genetic disorder which results in progressive degeneration of skeletal muscle.

178. With regard to insulin choose **correct** options.

- | |
|--|
| (a) C-peptide is not present in mature insulin. |
| (b) The insulin produced by rDNA technology has C-peptide. |
| (c) The pro-insulin has C-peptide |
| (d) A-peptide and B-peptide of insulin are interconnected by disulphide bridges. |

Choose the **correct** answer from the options given below

- | |
|---------------------------|
| (1) (b) and (d) only |
| (2) (b) and (c) only |
| (3) (a), (c) and (d) only |
| (4) (a) and (d) only |

Answer (3)

Sol. • Insulin is synthesized as a pro-hormone which contains A-chain, B-chain and an extra stretch called the C-peptide.

- C-peptide is not present in mature insulin called humulin.
- Chains A and B are connected by interchain disulphide bridges.

179. During the process of gene amplification using PCR, if very high temperature is not maintained in the beginning, then which of the following steps of PCR will be affected first?

- (1) Annealing (2) Extension
(3) Denaturation (4) Ligation

Answer (3)

Sol. • Option (3) is correct. High temperature about 94°C is required for the process of denaturation which is the first step of PCR.

- Ligation of DNA fragments is performed with the help of an enzyme called DNA ligase.
- Annealing is performed at 50°-60°C which is the second step that can get affected.
- Addition of nucleotides to the primer, synthesizing a new DNA strand using only the template sequences with the help of enzyme DNA polymerase is called primer extension/polymerisation.

180. Which enzyme is responsible for the conversion of inactive fibrinogens to fibrins?

- (1) Thrombin (2) Renin
(3) Epinephrine (4) Thrombokinas

Answer (1)

Sol. During coagulation of blood, an enzyme complex thrombokinas helps in the conversion of prothrombin (present in plasma) into thrombin.

Thrombin further helps in the conversion of inactive fibrinogens into fibrins which form network of threads.

Renin is secreted by JG cells in response to fall in glomerular blood flow, which converts angiotensinogen in blood to angiotensin-I

Epinephrine or adrenaline is secreted by adrenal medulla in response to stress of any kind and during emergency.

181. Succus entericus is referred to as:

- (1) Pancreatic juice (2) Intestinal juice
(3) Gastric juice (4) Chyme

Answer (2)

Sol. • Option (2) is correct because succus entericus is referred to as intestinal juice.

- Chyme is name given to acidic food present in stomach.
- Exocrine secretion of pancreatic acini is called pancreatic juice.
- Secretion of gastric glands present in stomach is called gastric juice.

182. Select the favourable conditions required for the formation of oxyhaemoglobin at the alveoli.

- (1) High pO_2 , low pCO_2 , less H^+ , lower temperature
(2) Low pO_2 , high pCO_2 , more H^+ , higher temperature
(3) High pO_2 , high pCO_2 , less H^+ , higher temperature
(4) Low pO_2 , low pCO_2 , more H^+ , higher temperature

Answer (1)

Sol. • The factors favourable for the formation of oxyhaemoglobin at the alveolar level are; high pO_2 , low pCO_2 , less H^+ concentration and lower temperature.

- The conditions favourable for the dissociation of oxygen from oxyhaemoglobin at the tissue level are; low pO_2 , high pCO_2 , high H^+ concentration and high temperature.

183. Which one of the following is an example of Hormone releasing IUD?

- (1) CuT
(2) LNG 20
(3) Cu 7
(4) Multiload 375

Answer (2)

Sol. • LNG-20 is a hormone releasing IUD which makes the uterus unsuitable for implantation and the cervix hostile to sperms.

- Multiload 375, CuT and Cu7 are copper releasing IUDs which suppress sperm motility and the fertilizing capacity of sperms.

184. Sphincter of oddi is present at:

- (1) Ileo-caecal junction
- (2) Junction of hepato-pancreatic duct and duodenum
- (3) Gastro-oesophageal junction
- (4) Junction of jejunum and duodenum

Answer (2)

Sol. • The bile duct and the pancreatic duct open together into the duodenum as the common hepato-pancreatic duct which is guarded by a sphincter called the sphincter of Oddi.

- Ileo-caecal valve is present at the junction of ileum and caecum to prevent the backflow of faecal matter into the ileum in humans.
- Gastro-oesophageal sphincter regulates the opening of oesophagus into stomach.

185. Read the following statements

- (a) Metagenesis is observed in Helminths.
- (b) Echinoderms are triploblastic and coelomate animals.
- (c) Round worms have organ-system level of body organization.
- (d) Comb plates present in ctenophores help in digestion.
- (e) Water vascular system is characteristic of Echinoderms.

Choose the **correct** answer from the options given below.

- (1) (c), (d) and (e) are correct
- (2) (a), (b) and (c) are correct
- (3) (a), (d) and (e) are correct
- (4) (b), (c) and (e) are correct

Answer (4)

Sol. • Metagenesis (alternation of generation) is observed in members of phylum Coelenterata (Cnidaria).

- Echinoderms are triploblastic and coelomate animals as true coelom is observed in them.
- Roundworms (Aschelminths) have organ system level of organization.
- Comb plates present in ctenophores help in locomotion.
- Water vascular system is seen in echinoderms, which helps in locomotion, capture and transport of food and respiration.

SECTION - B

186. Which of these is not an important component of initiation of parturition in humans ?

- (1) Increase in estrogen and progesterone ratio
- (2) Synthesis of prostaglandins
- (3) Release of Oxytocin
- (4) Release of Prolactin

Answer (4)

Sol. • At the end of gestation, the completely developed foetus is expelled out. This process is called parturition.

- Parturition is controlled by a complex neuroendocrine mechanism.
- Estrogen and progesterone ratio increases as estrogen levels rise significantly.
- Prostaglandins, which stimulate uterine contractions are also produced that act on myometrium.
- Oxytocin, the main hormone, also called as birth hormone is released by maternal pituitary, which brings about strong uterine contractions.
- Prolactin is a lactation hormone that has no role in initiation of parturition.

187. During muscular contraction which of the following events occur?

- (a) 'H' zone disappears
- (b) 'A' band widens
- (c) 'I' band reduces in width
- (d) Myosine hydrolyzes ATP, releasing the ADP and Pi.
- (e) Z-lines attached to actins are pulled inwards.

Choose the **correct** answer from the options given below:

- (1) (a), (c), (d), (e) only
- (2) (a), (b), (c), (d) only
- (3) (b), (c), (d), (e) only
- (4) (b), (d), (e), (a) only

Answer (1)

Sol. The correct option is (1) because the length of A-band is retained. During muscle contraction, the following events occur:

- (1) The globular head of myosin acts as ATPase and hydrolyses ATP molecule and eventually leads to the formation of cross bridge.
- (2) This pulls the actin filament towards the centre of 'A-band'.
- (3) The Z-line attached to these actins are also pulled inwards thereby causing a shortening of the sarcomere.
- (4) The thin myofilaments move past the thick myofilaments due to which the H-zone narrows. This reduces the length of I-band but retains the length of A-band.
- (5) The myosin then releases ADP+Pi, and goes back to its relaxed state.

188. Following are the statements with reference to 'lipids'.

- (a) Lipids having only single bonds are called unsaturated fatty acids
- (b) Lecithin is a phospholipid.
- (c) Trihydroxy propane is glycerol.
- (d) Palmitic acid has 20 carbon atoms including carboxyl carbon.
- (e) Arachidonic acid has 16 carbon atoms.

Choose the **correct** answer from the options given below.

- (1) (a) and (b) only
- (2) (c) and (d) only
- (3) (b) and (c) only
- (4) (b) and (e) only

Answer (3)

- Sol.**
- The correct option is (3) because lipids having only single bonds are called saturated fatty acids and lipids having one or more C = C double bonds are called unsaturated fatty acids.
 - Palmitic acid has 16 carbon atoms including carboxyl carbon.
 - Arachidonic acid has 20 carbon atoms including the carboxyl carbon.
 - Lecithin is a phospholipid found in cell membrane.
 - Glycerol has 3 carbons, each bearing a hydroxyl (-OH) group.

189. Which of the following is **not** a step in Multiple Ovulation Embryo Transfer Technology (MOET)?

- (1) Cow is administered hormone having LH like activity for super ovulation
- (2) Cow yields about 6-8 eggs at a time
- (3) Cow is fertilized by artificial insemination
- (4) Fertilized eggs are transferred to surrogate mothers at 8-32 cell stage

Answer (1)

Sol. Multiple Ovulation Embryo Transfer Technology is used for herd improvement in short time.

- Cows are administered hormones, with FSH-like activity for superovulation.
- 8-32 celled embryos are transferred to surrogate mothers.
- 6-8 eggs are produced per cycle.
- Cows can be fertilised by artificial insemination.

190. Identify the types of cell junctions that help to stop the leakage of the substances across a tissue and facilitation of communication with neighbouring cells via rapid transfer of ions and molecules.

- (1) Gap junctions and Adhering junctions, respectively
- (2) Tight junctions and Gap junctions, respectively
- (3) Adhering junctions and Tight junctions, respectively.
- (4) Adhering junctions and Gap junctions, respectively

Answer (2)

Sol. Three types of junctions are found in tissues

- Tight junctions stop leakage of substances from leaking across a tissue.
- Adhering junctions cement and keep neighbouring cells together.
- Gap junctions or communication junctions facilitate communication between cells by connecting the cytoplasm of adjoining cells.

191. The Adenosine deaminase deficiency results into

- (1) Dysfunction of Immune system
- (2) Parkinson's disease
- (3) Digestive disorder
- (4) Addison's disease

Answer (1)

Sol. Adenosine deaminase (ADA) enzyme is crucial for the immune system to function. Hence, its deficiency results in the dysfunction of immune system.

- Hyposecretion of hormones of the adrenal cortex causes Addison's disease.
- Parkinson's disease is a long-term degenerative disorder of the central nervous system.
- Disorders which affect GIT & associated glands are called digestive disorders.

192. **Statement I:** The codon 'AUG' codes for methionine and phenylalanine.

Statement II: 'AAA' and 'AAG' both codons code for the amino acid lysine.

In the light of the above statements, choose the **correct** answer from the options given below.

- (1) Both **Statement I** and **Statement II** are true
- (2) Both **Statement I** and **Statement II** are false
- (3) **Statement I** is correct but **Statement II** is false
- (4) **Statement I** is incorrect but **Statement II** is true

Answer (4)

Sol. • AUG has dual functions, it codes for methionine. It also acts as initiator codon.

- AUG does not code for phenylalanine.
- Statement II is true.

193. Match List-I with List-II

List -I		List -II	
(a)	Scapula	(i)	Cartilaginous joints
(b)	Cranium	(ii)	Flat bone
(c)	Sternum	(iii)	Fibrous joints
(d)	Vertebral column	(iv)	Triangular flat bone

Choose the correct answer from the options given below

- | | (a) | (b) | (c) | (d) |
|-----|------|-------|-------|------|
| (1) | (i) | (iii) | (ii) | (iv) |
| (2) | (ii) | (iii) | (iv) | (i) |
| (3) | (iv) | (ii) | (iii) | (i) |
| (4) | (iv) | (iii) | (ii) | (i) |

Answer (4)

Sol. The correct option is (4).

- Scapula is a large triangular flat bone situated in the dorsal part of the thorax between the second and the seventh ribs.
- Fibrous joint is shown by the flat skull bones which fuse end-to-end with the help of dense fibrous connective tissues in the form of sutures, to form the cranium.
- Sternum is a flat bone on the ventral midline of thorax.
- Cartilaginous joints between the adjacent vertebrae in the vertebral column permits limited movements.

194. Match List-I with List-II

List -I		List -II	
(a)	Filariasis	(i)	<i>Haemophilus influenzae</i>
(b)	Amoebiasis	(ii)	<i>Trichophyton</i>
(c)	Pneumonia	(iii)	<i>Wuchereria bancrofti</i>
(d)	Ringworm	(iv)	<i>Entamoeba histolytica</i>

Choose the **correct** answer from the options given below

- | | (a) | (b) | (c) | (d) |
|-----|-------|-------|-------|-------|
| (1) | (iv) | (i) | (iii) | (ii) |
| (2) | (iii) | (iv) | (i) | (ii) |
| (3) | (i) | (ii) | (iv) | (iii) |
| (4) | (ii) | (iii) | (i) | (iv) |

Answer (2)

Sol. The correct option is (2).

- Filariasis is the disease caused by *Wuchereria bancrofti*, filarial worm.
- Amoebiasis/Amoebic dysentery is caused by a protozoan parasite *Entamoeba histolytica* in the large intestine of human.
- Pneumonia is caused by bacteria like *Streptococcus pneumoniae* and *Haemophilus influenzae*.
- Ringworm is caused by fungi belonging to genera *Microsporum*, *Trichophyton* and *Epidermophyton*.

195. Following are the statements about prostomium of earthworm.
- It serves as a covering for mouth.
 - It helps to open cracks in the soil into which it can crawl.
 - It is one of the sensory structures.
 - It is the first body segment.

Choose the **correct** answer from the options given below.

- (a), (b) and (c) are correct
- (a), (b) and (d) are correct
- (a), (b), (c) and (d) are correct
- (b) and (c) are correct

Answer (1)

- Sol.** • The anterior end of the earthworm has mouth which has covering called prostomium.
- Prostomium acts as a wedge to force open cracks in the soil.
 - Prostomium has receptors, so it is sensory in function.
 - The first body segment of earthworm is the peristomium

196. Which of the following secretes the hormone, relaxin, during the later phase of pregnancy?
- Graafian follicle
 - Corpus luteum
 - Foetus
 - Uterus

Answer (2)

- Sol.** The hormone relaxin is produced in the later phase of pregnancy. It is produced by the ovary.
- Graafian follicle is not formed when the woman is pregnant.
 - Uterus and foetus do not produce relaxin.
 - Relaxin is produced by the corpus luteum present in the ovary. Ruptured Graafian follicle is called corpus luteum, which has endocrine function.

197. Which one of the following statements about Histones is **wrong**?
- Histones are organized to form a unit of 8 molecules
 - The pH of histones is slightly acidic
 - Histones are rich in amino acids - Lysine and Arginine
 - Histones carry positive charge in the side chain

Answer (2)

- Sol.** • Histones are rich in basic amino acids residue lysine and arginine with charged side chain.
- There are five types of histone proteins *i.e.*, H₁, H₂A, H₂B, H₃ and H₄. Four of them occur in pairs to produce a unit of 8 molecules (histone octamer)
 - The pH of histones is basic.

198. **Assertion (A):** A person goes to high altitude and experiences 'altitude sickness' with symptoms like breathing difficulty and heart palpitations.

Reason (R): Due to low atmospheric pressure at high altitude, the body does not get sufficient oxygen.

In the light of the above statements, choose the correct answer from the options given below

- Both (A) and (R) are true and (R) is the correct explanation of (A)
- Both (A) and (R) are true but (R) is not the correct explanation of (A)
- (A) is true but (R) is false
- (A) is false but (R) is true

Answer (1)

- Sol.** Altitude sickness can be experienced at high altitude where body does not get enough oxygen due to low atmospheric pressure and causes nausea, fatigue and heart palpitations.

Hence correct option is (1) as [R] is correct explanation of [A].

199. Match List-I with List - II

List - I		List - II	
(a)	Allen's Rule	(i)	Kangaroo rat
(b)	Physiological adaptation	(ii)	Desert lizard
(c)	Behavioural adaptation	(iii)	Marine fish at depth
(d)	Biochemical adaptation	(iv)	Polar seal

Choose the **correct** answer from the options given below.

- | | (a) | (b) | (c) | (d) |
|-----|------|-------|-------|-------|
| (1) | (iv) | (ii) | (iii) | (i) |
| (2) | (iv) | (i) | (iii) | (ii) |
| (3) | (iv) | (i) | (ii) | (iii) |
| (4) | (iv) | (iii) | (ii) | (i) |

Answer (3)

- Sol.**
- Polar seal generally has shorter ears and limbs (extremities) to minimise heat loss. This is with reference to Allen's rule.
 - Kangaroo rat exhibits physiological adaptation.
 - Desert lizard shows behavioural adaptation. They lack the physiological ability to cope-up with extreme temperature but manage the body temperature by behavioural means.
 - Marine fishes at depth are adapted biochemically to survive in great depths in ocean.

200. Match List - I with List - II

List - I		List - II	
(a)	Adaptive radiation	(i)	Selection of resistant varieties due to excessive use of herbicides and pesticides
(b)	Convergent evolution	(ii)	Bones of forelimbs in Man and Whale
(c)	Divergent evolution	(iii)	Wings of Butterfly and Bird
(d)	Evolution by anthropogenic action	(iv)	Darwin Finches

Choose the **correct** answer from the options given below.

- | | (a) | (b) | (c) | (d) |
|-----|-------|-------|-------|-------|
| (1) | (iv) | (iii) | (ii) | (i) |
| (2) | (iii) | (ii) | (i) | (iv) |
| (3) | (ii) | (i) | (iv) | (iii) |
| (4) | (i) | (iv) | (iii) | (ii) |

Answer (1)

Sol. The correct option is (1)

- Adaptive radiation is the process of evolution of different species in a given geographical area starting from a point and literally radiating to other areas of geography, for example : Darwin's finches.
- Analogous organs which are not anatomically similar structures though they perform similar functions, are a result of convergent evolution, for example: Wings of butterfly and of birds.
- Homologous organs which are anatomically similar structures but perform different functions according to their needs, are a result of divergent evolution, for example : Bones of forelimbs in man and whale.
- Evolution by anthropogenic action means evolution due to human interference, for example: Antibiotic resistant microbes, herbicides resistant varieties and pesticide resistant varieties.

