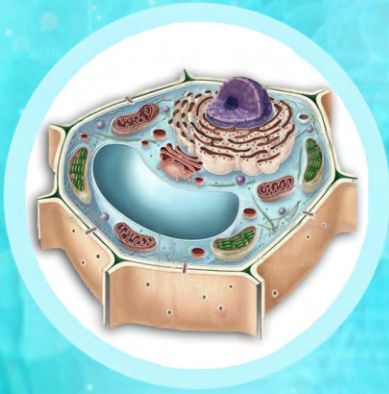




# BIOLOGY

## Standard XI



# The Constitution of India

## Chapter IV A

### Fundamental Duties

#### ARTICLE 51A

**Fundamental Duties- It shall be the duty of every citizen of India—**

- (a) to abide by the Constitution and respect its ideals and institutions, the National Flag and the National Anthem;
- (b) to cherish and follow the noble ideals which inspired our national struggle for freedom;
- (c) to uphold and protect the sovereignty, unity and integrity of India;
- (d) to defend the country and render national service when called upon to do so;
- (e) to promote harmony and the spirit of common brotherhood amongst all the people of India transcending religious, linguistic and regional or sectional diversities, to renounce practices derogatory to the dignity of women;
- (f) to value and preserve the rich heritage of our composite culture;
- (g) to protect and improve the natural environment including forests, lakes, rivers and wild life and to have compassion for living creatures;
- (h) to develop the scientific temper, humanism and the spirit of inquiry and reform;
- (i) to safeguard public property and to abjure violence;
- (j) to strive towards excellence in all spheres of individual and collective activity so that the nation constantly rises to higher levels of endeavour and achievement;
- (k) who is a parent or guardian to provide opportunities for education to his child or, as the case may be, ward between the age of six and fourteen years.

The Coordination Committee formed by GR No. Abhyas - 2116/(Pra.Kra.43/16) SD - 4 Dated 25.4.2016 has given approval to prescribe this textbook in its meeting held on 20.06.2019 and it has been decided to implement it from academic year 2019-20.

# BIOLOGY

Standard XI



2019

**Maharashtra State Bureau of Textbook Production and Curriculum Research, Pune.**



F8I2K9

Download DIKSHA App on your smartphone. If you scan the Q.R.Code on this page of your textbook, you will be able to access full text. If you scan the Q.R.Code provided, you will be able to access audio-visual study material relevant to each lesson, provided as teaching and learning aids.

**First Edition : 2019**

**Reprint : 2022**

© **Maharashtra State Bureau of Textbook Production and Curriculum Research, Pune - 411 004.**

The Maharashtra State Bureau of Textbook Production and Curriculum Research reserves all rights relating to the book. No part of this book should be reproduced without the written permission of the Director, Maharashtra State Bureau of Textbook Production and Curriculum Research, 'Balbharati', Senapati Bapat Marg, Pune 411004.

**Subject Committee:**

Dr. Chandrashekhar V. Murumkar,  
**(Chairman)**

Dr. Avinash Ade

Dr. Naikare Shriram Maruti

Dr. Prakash Lohar

Dr. Madhav Pralhad Bhilve

Dr. Vishnu K. Vaze

Dr. Kiran Randive

Shri. Rajiv Arun Patole

**(Member Secretary)**

**Illustrations and cover :**

Shri Vivekanand S. Patil

**Coordinator :**

Shri. Rajiv Arun Patole

**Special Officer (Biology)**

**Typesetting :** DTP Section, Textbook  
Bureau, Pune

**Paper :** 70 GSM Cream wove

**Print Order :** N/PB/2022-23/40,000

**Printer :** SARASWATI BOOK COMPANY, PUNE

**Study Group:**

Dr. Nilima Milind Mulgund

Dr. Ravindra Kulkarni

Dr. Sanjay Arun Prabhu

Dr. Khade Ravi Narayan

Dr. Pawale Sandhya Rajendra

Dr. Sucheta Mihir Waghaye

Dr. Shinkhede Milind Manohar

Shri. Sandip Popatlal Chordiya

Shri. Pundalik Mallikarjun Sutar

Shri. Amey Prakash Edlabadkar

Shri. Prashant Pandurang Shirke

Smt. Manjusha Suresh Kulkarni

Smt. Revati Sunil Inamdar

Smt. Falguni Madlani

Smt. Varsha Anandrao Patil

Smt. Shubhangi Shankar Kapare

Smt. Shweta Dilip Thakur

**Production :**

Shri Sachchitanand Aphale

**Chief Production Officer**

Shri Prashant Harne

**Production Officer**

**Publisher :**

**Shri Vivek Uttam Gosavi**

**Controller**

Maharashtra State Textbook  
Bureau, Prabhadevi,  
Mumbai - 400 025



## The Constitution of India

### Preamble

WE, THE PEOPLE OF INDIA, having solemnly resolved to constitute India into a SOVEREIGN SOCIALIST SECULAR DEMOCRATIC REPUBLIC and to secure to all its citizens:

JUSTICE, social, economic and political;

LIBERTY of thought, expression, belief, faith and worship;

EQUALITY of status and of opportunity; and to promote among them all

FRATERNITY assuring the dignity of the individual and the unity and integrity of the Nation;

IN OUR CONSTITUENT ASSEMBLY this twenty-sixth day of November, 1949, do HEREBY ADOPT, ENACT AND GIVE TO OURSELVES THIS CONSTITUTION.

## NATIONAL ANTHEM

Jana-gana-mana-adhināyaka jaya hē  
Bhārata-bhāgya-vidhātā,

Panjāba-Sindhu-Gujarāta-Marāthā  
Drāvida-Utkala-Banga

Vindhya-Himāchala-Yamunā-Gangā  
uchchala-jaladhi-taranga

Tava subha nāmē jāgē, tava subha āsisa māgē,  
gāhē tava jaya-gāthā,

Jana-gana-mangala-dāyaka jaya hē  
Bhārata-bhāgya-vidhātā,

Jaya hē, Jaya hē, Jaya hē,  
Jaya jaya jaya, jaya hē.

## PLEDGE

India is my country. All Indians  
are my brothers and sisters.

I love my country, and I am proud  
of its rich and varied heritage. I shall  
always strive to be worthy of it.

I shall give my parents, teachers  
and all elders respect, and treat  
everyone with courtesy.

To my country and my people,  
I pledge my devotion. In their  
well-being and prosperity alone lies  
my happiness.

## Preface

Dear Students,

We welcome you all to Std. XI. For the first time, you are being introduced to the subject of Biology as a separate discipline. You have already been acquainted with some of the concepts of Biological Sciences from Standard five onwards, especially in the subject of General Science up to standard Eight and Science and Technology for standard Nine and Ten.

This textbook aims to create awareness about the biological sciences specially Botany, Zoology and allied aspects of biological sciences. The National Curriculum Framework (NCF) was formulated in 2005, followed by the State Curriculum Framework (SCF) in 2010. Based on the given these two frameworks, reconstruction of the curriculum and preparation of a revised syllabus has been undertaken which will be introduced from the academic year 2019-20. The textbook incorporating the revised syllabus has been prepared and designed by the Maharashtra State Bureau of Textbook Production and Curriculum Research, (Balbharati), Pune.

The subject biology intends to give students understanding, and appreciation of the vast diversity of living beings, their special adaptations to their environments and evolutionary relationships. No compromise is made in any manner over the use of language in the Biology context, but at the same time, the textbook is presented in a simple language. In addition, relevant diagrams, graphs, tables used in the textbook will bring about more clarity in the understanding of various terminologies and biological concepts. All the illustrations are in colour form. This will enable students to understand various concepts of botany and zoology thoroughly and correlate this with their day-to-day practical life. The new syllabus focuses on the conceptual principles of overall life processes, its understanding, and application in day-to-day life and ability to solve different upcoming problems and issues like conservation; different diseases and remedies, the application of technology, etc. The general teaching-learning objectives of the revised syllabus are further determined based on the 'principle of constructivism' i.e. self-learning.

The curriculum and syllabus confirms to the maxims of teaching such as moving from concrete to abstract, known to unknown and from part to whole. For the first time, in the syllabus of biology various independent activities have been introduced. These activities will not only help to understand the content knowledge but also provide scope for gaining relevant and additional application based knowledge on your own efforts. The detailed information of all concepts is also provided for the better understanding of the subject. Q. R. Code have been introduced for gaining the additional information, abstracts of chapters and practice questions/ activities.

The efforts taken to prepare the textbook will not only enrich the meaningful learning experience of the students, but also benefit other stakeholders such as teachers, parents as well as those aspiring candidates preparing for the competitive examinations.

We look forward to a positive response from the teachers and students.  
Our best wishes to all!



(Dr. Sunil Magar)

**Director**

Place : Pune

Date : 20 June 2019

Bharatiya Saur : 30 Jyestha 1941

Maharashtra State Bureau of Textbook  
Production and Curriculum Research,  
Pune, 411004

## - For Teachers -

### Dear Teachers,

We are happy to introduce the revised textbook of Biology for Std XI. This book is a sincere attempt to follow the maxims of teaching as well as develop a 'constructive' approach to enhance the quality of learning. The demand for more activity based, experiential and innovative learning opportunities is the need of the hour. The present curriculum has been restructured so as to bridge the credibility gap that exists between what is taught and what students learn from direct experience in the outside world. Guidelines provided below will help to enrich the teaching-learning process and achieve the desired learning outcomes.

- To begin with, get familiar with the textbook yourself.
- The present book has been prepared for constructive and activity-based teaching.
- Teachers must skillfully plan and organize the activities provided in each chapter to develop interest as well as to stimulate the thought process among the students.
- Always teach with proper planning.
- Use teaching aids as required for the proper understanding of the subject.
- Do not finish the chapter in short.
- Follow the order of the chapters strictly as listed in the contents because the units are introduced in a graded manner to facilitate knowledge building.
- Facilitate peer learning as much as possible by reorganizing the class structure frequently.
- Teaching-learning interactions, processes and participations of all students are very essential and so is your active guidance.
- Ask questions based on previous knowledge of different concepts of lesson.
- Do not use the boxes titled 'Do you know?' for evaluation. However, teachers must ensure that students read this extra information.
- Information provided in boxes with the title 'Can You Tell', 'Always Remember' should be considered for evaluation.
- Exercises provided after each unit are prepared using different parameters like observation, co-relation, critical thinking, analytical reasoning etc.
- Evaluation pattern should be based on the above mentioned parameters. Equal weight age should be assigned to all the topics. Use different combinations of questions. Stereotype questions should be avoided.
- Use demonstration, discussion method for teaching.
- 'Can You Recall' is the first main starting point of lesson which helps for the introduction of topic. This will also helpful for students regarding understanding the content of lesson.
- Use QR Code given in the textbook. Keep checking the QR Code for updated information.
- 'Internet My Friend' is used for collecting extra important information related to topic.
- 'Use Your Brain Power' is used for the application level questions in different lessons.
- 'Do Your Self', 'Find Out', 'Observe and Discuss' and 'Try This' are used for activity based learning.
- 'Know the Scientist' is used for the information of different scientist related to concepts in lesson.
- 'Activity' is used in lesson and exercise for better understanding and application of the content which studied.
- Exercise is given at the end of lesson. In exercise different type of questions/ activities are given.
- Teacher should use their freedom to acquaint the students with flora and fauna of given region.
- Remember that mathematical and statistical tools are also important to understand biology
- List of abbreviations are provided towards the end of the textbook for further clarification.

Best wishes for a wonderful teaching experience and fruitful welcome!



## Competency Statements

### Standard XI

<b>Unit</b>	<b>Competency Statements</b> <b>After studying the content in Textbook students will ...</b>
<b>Diversity in living world</b>	<ul style="list-style-type: none"><li>Analyse basic characteristics of living and non-living.</li><li>Collect and analyse useful data by observing diversity of living organisms using different tools.</li><li>Describe plants and animals in the surrounding on scientific basis and classify them using taxonomic hierarchy.</li><li>Develop hobbies by watching and collecting the things (livings) and their conservation using databases.</li><li>Classify different organisms based on cell structure, body organisation, mode of nutrition etc.</li><li>Compare and analyse similarities and differences along with phylogeny amongst different groups of organisms.</li><li>Recognize, analyse and compare structural similarities and differences and progressive evolutionary changes in different plants and animals.</li></ul>
<b>Cell structure and functions</b>	<ul style="list-style-type: none"><li>Explain and draw the structure and functions of different cell organelles.</li><li>Elaborate the role of nucleus in heredity and controlling characters with structure of chromosome.</li><li>Compare cell division process and know their role in life cycle of organisms.</li><li>Analyse and specify different biomolecules of cell with their role in structural and functional aspect of cell.</li></ul>
<b>Structural organization in organisms</b>	<ul style="list-style-type: none"><li>Explain basic morphology of dominant plant group of this era i.e. Angiosperms.</li><li>Compare morphological features of different plant parts in different plant families.</li><li>Draw floral parts and floral diagram.</li><li>Identify economic importance of Angiosperms with respect to fruit and seeds.</li><li>Compare morphological features of two major classes of Angiosperms.</li><li>Explain different types of tissues in plants and reasons for growth viz. primary and secondary.</li><li>Analyse basic differences in anatomy of different plants like dicot and monocots with respect to root, stem and leaf.</li><li>Elaborate different animal tissues and their role.</li><li>Explain and draw mechanisms of different physiological process like digestion and excretion.</li><li>Review the contribution of different scientists in systematics and taxonomy.</li></ul>
<b>Plant physiology</b>	<ul style="list-style-type: none"><li>Explain the scientific reasons behind the various physiological activities based on relationship.</li><li>Understand the relationship between chemical reactions of molecules in daily life and analyse them to solve various problems.</li><li>Review the contribution made by different workers.</li><li>Plan and implement programs about conservation of environment.</li><li>Explain the importance of green energy and save energy in daily life.</li></ul>

**Animal  
Physiology**

- Explain the need and importance of various physiological processes.
- Explain the structural modifications, observed in various living organisms to carry out various physiological processes.
- Observe and correlate the histological structure of various organs with their function.
- Comprehend mechanisms by which these physiological processes help maintain homeostasis.
- Create memory maps, flow charts to depict major events in these processes.
- Develop insight about connection between life style/habits and physiological disorders.
- Collect information about latest diagnostic tools and treatments for various physiological disorders.
- Critically analyse given situational data and come up with rationale of possible physiological disorders/suggest proper remedial measures.
- Perform various analytical tests to detect presence of certain components in food materials/waste products.

**Contents**

Sr. No.	Name of the lesson	Page No.
1.	Living World	1 - 5
2.	Systematics of Living Organisms	6 - 18
3.	Kingdom Plantae	19 - 28
4.	Kingdom Animalia	29 - 43
5.	Cell Structure and Organization	44 - 58
6.	Biomolecules	59 - 75
7.	Cell Division	76 - 84
8.	Plant Tissues and Anatomy	85 - 96
9.	Morphology of Flowering Plants	97 - 115
10.	Animal Tissue	116 - 126
11.	Study of Animal Type : Cockroach	127 - 137
12.	Photosynthesis	138 - 150
13.	Respiration and Energy Transfer	151 - 160
14.	Human Nutrition	161 - 173
15.	Excretion and Osmoregulation	174 - 192
16.	Skeleton and Movement	193 - 214

**DISCLAIMER Note :** All attempts have been made to contact copy right/s (©) but we have not heard from them. We will be pleased to acknowledge the copy right holder (s) in our next edition if we learn from them.

# 1. Living World



## Can you recall?

1. What is the difference between living and non-living?
2. Enlist the characters of living organisms.
3. Whether all organisms are similar? Justify your answer.

Planet earth is made up of abiotic and biotic components. The biotic components are obviously the living beings present around us. The question is why do we call them living and how do they differ from non-living?

### 1.1 Basic principles of life :

**A.** The living being once produced / born has to survive. For survival, it needs energy and many chemical molecules. For energy, it has to perform metabolism. Metabolism is breaking of molecules (**catabolism**) and making of new molecules (**anabolism**).

**B.** From birth onwards, organisms show tendency of growth and development. This **growth** is a well-orchestrated process. You might have observed sand mounds, boulders grow, etc. This growth is not from within and hence these are not living beings.

**C.** Growth and development are not the processes which have unlimited time span. At certain point of time, the molecules, organs, systems begin to lose their effective working and become old. This is **ageing** process of the body.

**D.** Life has to continue (perpetuate) hence the organism tries to produce a young one like itself. It is possible through reproduction (asexual or sexual). This ensures continuity of race. Mules, sterile worker bees do not reproduce, yet are living. Can we call reproduction as inclusive characteristic of life?

**E.** As the body loses its capacity to perform metabolism, the organism dies i.e. does not remain immortal.

**F.** Any living being responds to thermal, chemical or biological changes in the surrounding. Responsiveness or irritability is unique property of living beings.

There is immense diversity in living organisms. Since time immemorial, variety of organisms are living together on earth. In order to understand the interrelations between living and non-living as well as between two living beings or groups, systematic study of these is essential. This data is also important for various industries and agriculture. Intensive laboratory and field studies in order to identify and classify the organisms form strong basis for meaningful use of the collected data. If we need to study this diversity, certain aids called taxonomical aids can be used. These include herbaria, botanical gardens, museums, biodiversity parks, zoological parks, etc.



## Can you tell?

1. How can we study large number of organisms at a glance?
2. Whether all organisms prepare their own food?
3. Which feature can be considered as all inclusive characteristic of life? Why?



## Think about it

1. Can metabolic reactions demonstrated in a test tube (called '*in vitro*' tests) be called living?
2. Now a days patients are declared 'brain dead' and are on life support. They do not show any sign of self-consciousness. Are they living or non-living?

### 1.2 Herbarium :

The word herbarium (plural-herbaria) was coined by Pitton de Tournefort in the book 'Elemens'. The art of herbarium was initiated by an Italian taxonomist Luca Ghini (1490-1556). Herbaria are effective tools in taxonomic studies. A herbarium is essentially a dried plant specimen that is pressed, treated variously and then mounted on standard size sheet in order to preserve it.

Date, place of collection along with detailed classification and highlighting with its ecological peculiarities, characters of the plant are also recorded on the same sheet. Local names and name of the collector may be added. This information is given at lower right corner of sheet and is called 'label'.



**Fig. 1.1 Herbarium**

### 1.3 Botanical Gardens :

Botanical gardens are the places where living plants of different varieties collected from different parts of the world, are grown in a scientific and systematic way in a *in vivo* manner. Plants are labelled. The label-board shows scientific as well as common name of the plant.



### Know the scientists

In 1543, first botanical garden of the world was established by an Italian Prof. Luca Ghini (A. D. 1490-1556) at Pisa, Italy. Botanical garden at Kew in England is known for largest collection of more than 30,000 specimens (preserved plants) and more than 7 million herbaria.

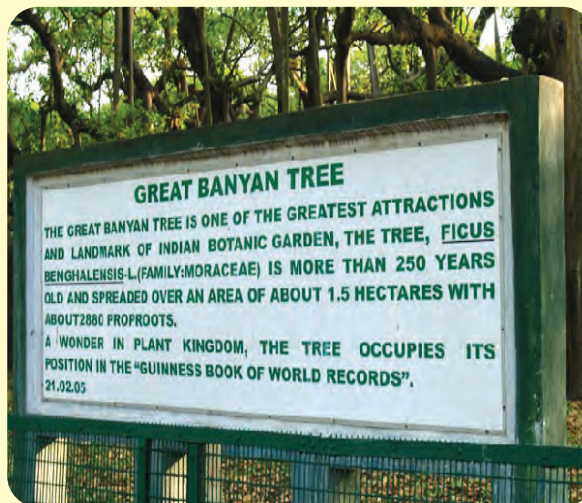


**Prof. Luca Ghini**



### Internet my friend

Collect information about Prof. Almeida, Prof. V. N. Naik, Dr. A. V. Sathe, Dr. P. G. Patwardhan with reference to their taxonomic work and biodiversity conservation.



**Fig. 1.2 Botanical Garden : Kolkata more than 255 years old Banyan tree**

### Conservation of Biodiversity :

Biodiversity is the degree of variation of life forms in an ecosystem. Biodiversity is essential to maintain ecological stability. The extent of complexity and density of biodiversity can be regarded as a measure of health of an ecosystem. Population explosion and over exploitation of resources have resulted in a loss of biodiversity at an alarming rate. Conservation involves attempting to slow down, stop or even reverse the loss in the natural habitat of organism. This is known as *in-situ* conservation. Why does the loss of biodiversity matter? For many people, it is a simple moral or ethical issue. We share our planet with a huge range of other organisms and we have no right to harm them. Biodiversity helps to maintain stability in an ecosystem. Loss of one variety of organisms can affect the entire ecosystem.

### 1.4 Museum :

Museums are the repositories where, collections of preserved plant and animal specimens are kept. Plant and animal specimens may be preserved in formalin (10% to 40% formaldehyde) in transparent jars. Jars are labelled. Larger animals like birds and mammals are usually stuffed and preserved. This science is known as **taxidermy**. Specimens in dried form are also exhibited in museum.

We can even find systematic collections of shells, skeletons of animals, insect boxes etc. in museums.

Thus, biological museums in educational institutes are reference hubs of biodiversity studies.



Fig. 1.3 Biological Museum

### 1.5 Zoological Parks :

Zoological Park generally known as zoo, is a place of interest for common man. In a zoo, wild animals are kept in captivity. They are protected and care is taken to provide conditions similar to their natural habitat. (*ex-situ*) In a zoo, a naturalist can study food habits and behaviour of animals.

Flora, manuals, Monographs and Catalogue are some other tools of maintaining biodiversity records. Flora is the plant life occurring in a particular area on time. A **Monograph** describes any one selected biological group where as **manual** provides information, keys about identification of species found in a particular area.



Fig. 1.4 Zoological Park



### Can you tell?

1. What are the essentials of a good herbarium?
2. Why should we visit botanical gardens, museums and zoo?
3. What is '*ex-situ*' and '*in-situ*' conservation?

### 1.6 Biodiversity parks :

It is an ecological assemblage of species that form self-sustaining communities on degraded / barren landscape e.g. Late Uttamrao Patil biodiversity park Gureghar, Mahabaleshwar. This park is the best model for conservation of natural heritage in urban landscape.

Systematic classification of living organisms is helpful in understanding the interrelations. In order to understand interrelations between organisms and maintaining harmony on planet earth, the study of biodiversity is a must.



### Know the scientists

#### Dr. S. P. Agharkar

One of the leading botanists of India, Dr. S. P. Agharkar was born in November 1884 in Malvan, Maharashtra. He explored biodiversity of Western Ghats where he came across a species of freshwater jellyfish, which was until then only known to be found in Africa. These findings were published in scientific journal Nature in 1912. Dr. Annandale, the Superintendent of the Indian Museum in Kolkata, helped Dr. Agharkar in his further endeavours to collect, preserve and conduct microscopic examinations of animal and plant specimens. The institute ARI, Pune has been named after him.



### 1.7 Key :

Key is taxonomical aid used for classification of plants and animals. The dichotomous keys are based on contrasting characters. One of the contrasting characters gets accepted and other rejected. The statement in key is called a lead. Normally keys are analytical in nature. Let us study about classification of living organisms in next chapter.



### Do you know ?

When plants from any forest locality are conserved on the name of holy place it is called as sacred groves. These are also considered as sacred natural sites by IUCN.



### Internet my friend

1. Collect information about botanical gardens, zoological parks and biodiversity hot spots in India.
2. Gather information of endemic flora and fauna of India.



### Find out

Human being is at key position in maintaining biodiversity of earth. Find out more information about the following.

1. Laws to protect and conserve biodiversity in India.
2. Environmental effects of ambitious projects like connecting rivers or connecting cities by constructing roads.
3. Did Bauxite mining in Western Ghats affect critically endangered species like – Black panther, different *Ceropegia spp.*, *Eriocaulon spp.*?



## Exercise

### 1. Choose correct option

- A. Which is not a property of living being?
- Metabolism
  - Decay
  - Growth
  - Reproduction
- B. A particular plant is strictly a seasonal plant. Which one of the following is best suited if it is to be studied in the laboratory?
- Herbarium
  - Museum
  - Botanical garden
  - Flower exhibition
- C. A group of students found two cockroaches in the classroom. They had a debate whether they are alive or dead. Which life property will help them to do so?
- Metabolism
  - Growth
  - Irritability
  - Reproduction

### 2. Distinguish between botanical gardens, zoological park and biodiversity park with reference to their characteristics

### 3. Answer the following questions

- A. Jijamata Udyan, the famous zoo in Mumbai has acclimatised the humbolt penguins. Why should penguins be acclimatised when kept at a place away from their natural habitat?
- B. Riya found peculiar plant on her visit to Himachal Pradesh. What are the ways she can show it to her biology teacher and get information about it?
- C. At Andaman, authorities do not allow tourists to collect shells from beaches. Why it must be so?
- D. Why do we have green house in botanical gardens?

- E. What do you understand from terms like *in situ* and *ex situ* conservation?

### 4. Write short notes on:

- A. Role of the human beings in biodiversity conservation.
- B. Importance of botanical garden.

### 5. How can you, as an individual, prevent the loss of Biodiversity?

#### Practical / Project :

- Make herbarium under the guidance of your teacher.
- Find out information about any one sacred grove (devrai) in Maharashtra.

## 2. Systematics of Living Organisms



### Can you recall?

What is five kingdom system of classification?

There is a great diversity of organisms around us. Since time immemorial, we humans have been exploiting this wealth for our own benefit. During this process man tried to differentiate between and identify the organisms. This evolved into a branch of biology known as classification that has led eventually to systematics. The methods of classification dates back to ancient time when Indian, Greek and Roman philosophers have contributed their might to systematise science.

### 2.1 Systematics :

“Systematics is the study of kinds and diversity of organisms and their comparative and evolutionary relationship”(G. Simpson, 1961).

### Taxonomy :

Taxonomy means classification following certain rules or principles. Word Taxonomy comes from two Greek words, taxis – meaning arrangement and nomos meaning law or rule. **The term taxonomy was first introduced by A. P. de Candolle (Swiss Botanist) [1778-1841].**

### 2.2 Classification :

It is the arrangement of organisms or groups of organisms in distinct categories in accordance with a particular and well established scheme or plan. This classification is based on similarities and dissimilarities among the organisms.

### Artificial :

It is the classification that is based on very few easily observable and non-evolutionary features such as habit, colour, etc.; often irrespective of their affinity (relationship) with other organisms. e.g. Linnaeus system of classification.

**Natural :** It is the classification which is based on objectively significant rather than being selected for convenience like artificial system of classification e.g. Bentham and Hooker's system of classification.

**Phylogenetic :** It is the classification based on common evolutionary descent. e.g. Engler and Prantl's classification.

In the system of classification the terms like ‘taxa’ and ‘categories’ are often used. Each category is referred as a unit of classification. In fact, it represents a rank and is commonly termed as taxon.

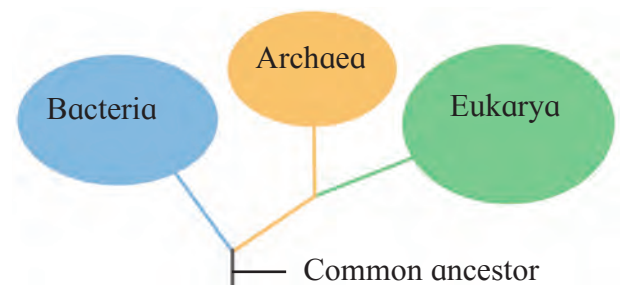


Fig 2.1 Phylogenetic descent

### 2.3 Three domains of life :

It is believed that the life originated on earth in its very simple form. Constant struggle of the early living beings gave rise to more and more perfect forms of life. This struggle and progress is evolution which led to appearance of diverse life forms. Carl Woese in 1990 proposed three domains of life to classify life forms. They are Archaea, Bacteria and Eukarya. Domain is an unit larger than Kingdom in the system of classification.

Bacteria and Archaea both have prokaryotic cells where as Eukarya have eukaryotic cell. All the three domains have very unique ribosomal RNA (rRNA). Archaea are known for their survival in very extreme conditions like high temperature, salinity, acidic conditions, etc. Bacteria, though are prokaryotes differ from Archaea in the structure of cell wall.



## 2.4 Chemotaxonomy :

It is method of biological classification based on similarities and differences in structure of certain compounds found among the organisms being classified. In short, it is the classification based on chemical constituents of organisms. e.g. Archaea cell wall is without peptidoglycan and that of Prokaryota is with peptidoglycan. Among Eukaryota, fungi have chitinous cell wall while plants have cellulosic cell wall.

## 2.5 Numerical taxonomy :

The system is based on quantification of characters and develops an algorithm for classification. The basic aim of this taxonomy was to create a taxonomy using numeric algorithms like cluster analysis rather than using subjective evaluation of their properties. This system was first proposed by R. Sokal and P. Sneath in 1963.

## 2.6 Cladogram :

It is a typical branching pattern. As shown on previous page, a diagram of three domains of life is a cladogram. (Fig 2.1). It represents a hypothetical relationship denoting a comparison of organisms and their common ancestors.

## 2.7 Phylogeny :

It is evolutionary relationship of organism. It is an important tool in classification as it takes into account not merely the morphological status but also the relationship of one group of organism with other groups of life. The system helps to understand the evolution and also focuses on the similarities of their metabolic functioning. Woese's three domain concept as well as Whittaker's five kingdom system are very good examples of phylogenetic relationship.

## 2.8 DNA barcoding :

DNA barcoding, is a new method for the identification of any species based on its DNA sequence from a tiny tissue sample of the organism under study.

It helps to study newly identified species as well as understanding the ecological and evolutionary relationships between living beings. The process of DNA barcoding includes two basic steps: (a) collecting DNA barcode data of known species and (b) matching the barcode sequence of the unknown sample against the barcode library for identification. DNA barcoding has many applications. A few to mention are, protection of endangered species, preservation of natural resources, pest control in agriculture, identifying disease vectors, authentication of natural health products and identification of medicinal plants.



### Can you tell?

1. Which characters of organisms are visible characters?
2. Name the recent approaches in taxonomy.
3. What is DNA barcoding?
4. What is evolution?
5. Enlist uses of taxonomy.

## 2.9 Taxonomic Categories :

Classification is not a single step process but involves hierarchy of steps in which each step represents a rank or category. Since the category is a part of overall taxonomic arrangement it is called taxonomic category and all categories in their increasing or retrogressive order together constitute the taxonomic hierarchy. Kingdom, division, class, order, family, genus, species are the categories in hierarchical sequence. These are compulsory categories. Besides, there are some facultative categories like sub-order, sub-family, etc. to be used as per need.

## 2.10 Taxonomic Hierarchy :

**Taxon :** A taxon is a taxonomic group of any rank in the system of classification (H.J. Lam 1948) e.g. in plant kingdom each one of the following such as Angiospermae, Dicotyledonae, Polypetalae, Malvaceae represents a taxonomic group i.e. a taxon.

Category	Taxon	Taxon
Kingdom	Plantae	Animalia
Division/Phylum	Angiospermae	Chordata
Class	Dicotyledonae	Reptilia
Sub-class	Polypetalae	Diapsida
Series	Thalamiflorae	-
Order	Malvales	Squamata
Family	Malvaceae	Elapidae
Genus	<i>Hibiscus</i>	<i>Naja</i>
Species	<i>rosa-sinensis</i>	<i>naja</i>

**Table 2.2 Classification of China-rose and Cobra**

### 2.11 Units of Classification :

- **Species :** Species is the principle lowest natural taxonomic unit, ranking below a genus and denoted by latin binomial (considered as the basic) unit of classification. It is a group of organisms that can interbreed under natural condition to produce fertile offspring. It was thought to be an indivisible, stable and static unit. However in the modern taxonomy, sub-division of species such as sub-species, varieties and populations are seen and given more importance.

- **Genus :** Genus is a higher taxonomic rank or category than species used, in the biological classification of living and fossil organisms. Genus is a group of species bearing close resemblance to one another in their morphological characters but they usually do not interbreed. e.g. Tiger, Leopard, Lion all three belong to same genus *Panthera* yet are different from each other. Another example is genus *Solanum*. Brinjal and potato both belong to this genus.

- **Family :** It is one of the major hierarchical taxonomic rank. A family represents a group of closely related genera. e.g. genera like *Hibiscus*, *Gossypium*, *Sida*, *Bombax* are included in same family Malvaceae. Cat also belongs to family of leopards, tigers and lions, family Felidae However dog belongs to different family Canidae.

- **Cohort / Order :** It is taxonomic rank used in the classification of organisms and recognised by nomenclature codes. An order is a group of closely related families showing definite affinities. Order thus is a step higher to family in the taxonomic hierarchy. Members belonging to same order but different families may show very few dissimilarities. e.g. family - Papaveraceae, Brassicaceae, Capparidaceae, etc with parietal placentation are grouped in order Parietales. Families of dogs and cats though are different, they belong to same order Carnivora.

- **Class :** The class is the distinct taxonomic rank of biological classification having its own distinctive name. It is a group of higher taxonomic rank than order. Class is the assemblage of closely related or allied orders. Orders **Carnivora** and order **Primates** belong to class **Mammalia**. Thus monkeys, gorillas, gibbons (Primates) and dogs, cats, tigers (**Carnivora**) belong to same class.

- **Division / Phylum :** The division is a category composed of closely related classes e.g. division. **Angiospermae** includes two classes - **Dicotyledonae** and **Monocotyledonae** (In animal classification division is a sub-unit of Category / Phylum).

- **Sub-kingdom :** Different divisions having some similarities form sub-kingdom. e.g. The divisions **Angiospermae** and **Gymnospermae** will form the sub-kingdom **Phanerogams** or **Spermatophyta**.

- **Kingdom :** It is the highest taxonomic category composed of different sub-kingdoms. e.g. sub-kingdom **Phanerogams** and **Cryptogams** form the Plant kingdom or Plantae which includes all the plants while all animals are included in kindom Animalia.

The taxonomic categories we have considered so far are broad categories. Scientists have added sub-categories to these in order to place organisms in more scientific and precise manner. You will observe that as we go higher in taxonomical ladder, number of common characters features go on decreasing.

If we are comparing two organisms that are related to each other only at division or phylum level, their classification may become difficult.



### Can you tell?

1. Why horse and ass are considered to be two different species or animals?
2. Make a flow chart showing taxonomic hierarchy.

## 2.12 Nomenclature :

Any object that becomes known to human intelligence must possess a name which may not be possible or convenient to describe it in order to communicate ideas about it. The art of naming the objects is in fact, a science called nomenclature. All living organisms are known by a particular name.

### 1. Vernacular / Local names / Common names:

Widely distributed organisms have a large number of common names. Pansy (*Viola tricolor* L.) grown in most European and American gardens has about 50 common English names. In a multilingual country like India, almost all useful plants have local names which differ from language to language and even from dialect to dialect. As in Ayurveda, mango (*Mangifera indica* L.) is known by over 50 different names, all in the Sanskrit language.

Hence the common names obviously have limited usage but for universal applications, a unique name for a particular individual is very much essential.

**2. Scientific Names :** Scientists have given scientific names to all the known organisms to overcome the difficulties raised by common names. These are systematic, thus provide means for international communication. Initially the polynomial system was used but Carl Linnaeus used binomial system of nomenclature where scientific name consists of two epithets (parts). He introduced this system in his book "Species Plantarum" published in 1753. International Code of Botanical Nomenclature (ICBN) has been set up to confirm the scientific names.

Before 2011, the code which was set up to confirm the scientific names was ICBN means International Code of Botanical Nomenclature. Recently XIX International Botanical Congress (IBC) was held in Shenzhen, China in July 2017. This code is also called "Shenzhen code", so the old code ICBN has been changed to ICNAPF means "International Code of Nomenclature for Algae, Fungi and Plants". This code was published on 26<sup>th</sup> June 2018.

According to this system the scientific name of sunflower is *Helianthus annuus*. Here *Helianthus* indicates name of the genus (generic epithet) and second word *annuus* denotes name of the species epithet.

### The Binomial Nomenclature system follows certain rules.

- Name of organism is composed of two Latin / Greek words.
- Generic epithet is a simple noun. It should come first and begin with capital letter.
- Specific epithet is the descriptive adjective which should come later and begin with small letter.
- Scientific epithet must be underlined separately if hand written and must be in italics, when printed.
- The generic and specific epithet should not have less than three letters and more than thirteen letters.
- Usually the name of the author who names a plant or animal is also written in full or abbreviated form after scientific name. e.g. *Mangifera indica* L. Where L stands for Linnaeus.



### Internet my friend

1. Collect the information about most recent system of classification of living organisms and Kingdom System of Classification. e.g. Search for APG system of classification for Plants.
2. Collect the information about classification systems for all types of organisms.



## Know the scientists

Carl Linnaeus classified living organisms in two kingdoms based on mode of nutrition, whether they are migratory, sedentary, etc. But this broad classification as Kingdom Plantae and Kingdom Animalia was found inadequate. It could not classify the organisms that show characters of both the Kingdoms for ex. Bacteria, Fungi, Euglena etc. Hence to avoid confusion scientist R.H. Whittaker (1969) proposed Five Kingdom system of classification. This system shows the Phylogenetic relationship between the organisms. The five kingdoms are.

1. Kingdom Monera
2. Kingdom Protista
3. Kingdom Plantae
4. Kingdom Fungi
5. Kingdom Animalia



R. H. Whittaker

### 2.13 Salient features of Five Kingdoms :

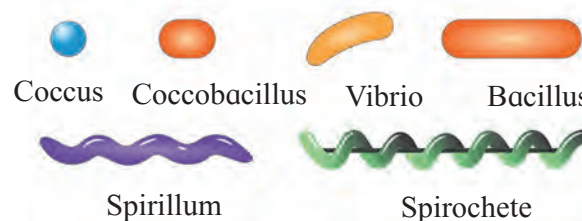
#### 1. Kingdom Monera :

These are unicellular organisms with prokaryotic cellular organization. Monera includes unicellular, prokaryotic organisms. These are omnipresent. They are found in all types of environment i.e. habitats which are not generally inhabited by other living beings. Nutritionally few are photoautotrophs or chemoautotrophs; but majority are heterotrophic in nature. These organisms do not have well defined nucleus. DNA exists as a simple double stranded circular, single ring without nuclear membrane, chromosome called as nucleoid. Smaller circular molecules of DNA as extra-chromosomal genetic elements called plasmids are often present. Cell wall is made up of peptidoglycan (also called murein) which is a polymer of sugars and amino acids.

Membrane bound organelles e.g. mitochondria, chloroplast, endoplasmic reticulum are absent. Ribosomes are smaller in size (70S) than in eukaryotic cells. The mode of reproduction in monera is asexual or with the help of binary fission or budding. Very rarely, sexual reproduction is by conjugation method.

Morphologically, bacteria are categorised into four groups, the spherical- **Coccus**, the rod-shaped **bacillus**, the comma or kidney shaped- **vibrio** and the spring like spiral- **spirillum**.

On the basis of evolution, bacteria can be classified as Archaeobacteria and Eubacteria.



**Fig. 2.3 Different shapes of bacterial cells**  
a. Archeobacteria :

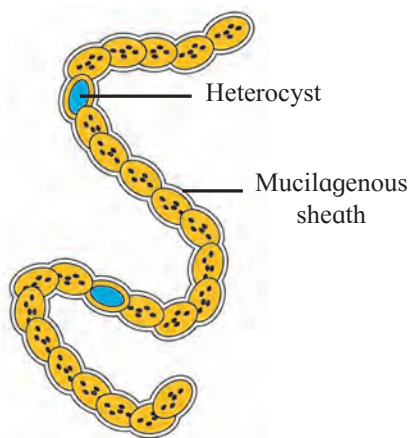
These are differentiated from other bacteria on the basis of their different cellular features. These bacteria are mostly found in the extreme environments; hence termed **extremophiles**. They are found in a variety of places from volcanic craters to salty lakes and hot springs. Their ability to withstand such hostile environment speaks of their capacity to survive in very severe conditions. Bacteria that can withstand high salinities are called **halophiles** while those that withstand extreme temperature are known as **thermophiles**. A very common example is of methanogenic bacteria found in gut of ruminants (cows and buffaloes). These bacteria help in production of methane in biogas plants. cell wall is without peptidoglycans. Reproduction by binary fission.

#### b. Eubacteria :

These are commonly referred as true bacteria. They have cell wall of peptidoglycan. They are found as autotrophs and heterotrophs. The autotrophs can be photosynthetic like *Chlorobium* (Green sulphur bacteria) and *Chromatium* or chemosynthetic like sulphur bacteria.

These are mostly multicellular filamentous forms living in fresh water. The body is covered by mucilagenous sheath. The genetic material is typical prokaryotic. Chl-a, Chl-b, carotenes and xanthothylls are the photosynthetic pigments. Filaments show heterocyst which helps in nitrogen fixation.

Heterotrophs are the most abundant. Most of them are decomposers and known for breaking down large molecules in simple molecules or minerals. They can be anaerobes helping in curdling of milk (*Lactobacilli*), fixation of nitrogen (*Azotobacter*), antibiotic production (*Streptomyces*), composting and degrading oil. But the story doesn't end here, some of them are pathogens i.e. causing disease (typhoid, cholera, tuberculosis, tetanus).



**Fig. 2.4 Cynaobacterium (*Nostoc*)**



**Can you tell?**

1. What are salient features of Monera?
2. What will be the shape of a bacillus and coccus type of bacteria?
3. Write a note on useful and harmful bacteria.

**Mycoplasma :**

These are smallest of the living forms. They do not have cell wall. Many forms are pathogenic. They are found resistant to common antibiotics due to absence of cell wall.

**2. Kingdom Protista :**

This group includes all the unicellular but eukaryotic organisms. These organisms show link with all eukaryotic Kingdoms like Plantae, Fungi and Animalia.

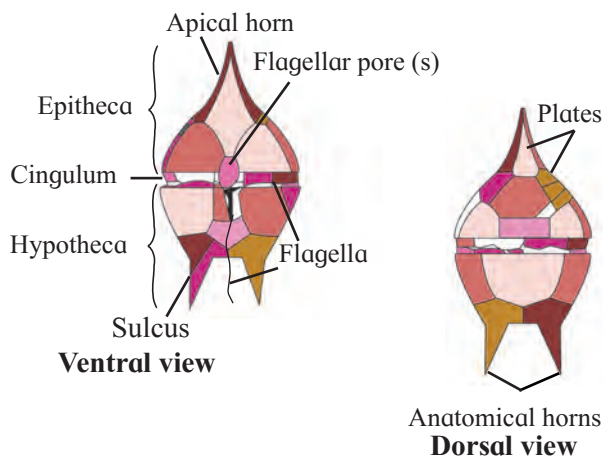
**a. Plant-like protists :**

They are also termed **Chrysophytes**. They are commonly termed phyto-planktons. They are microscopic and mostly photosynthetic and are major producers in oceans. Most of them are referred to as **diatoms** as they have body wall made up of two soap-box like fitting silica covers. "Diatomaceous earth" is nothing but these shells left behind for so many years. Diatomaceous earth is granular hence finds use in polishing and filtration.



**Fig. 2.5 Diatoms**

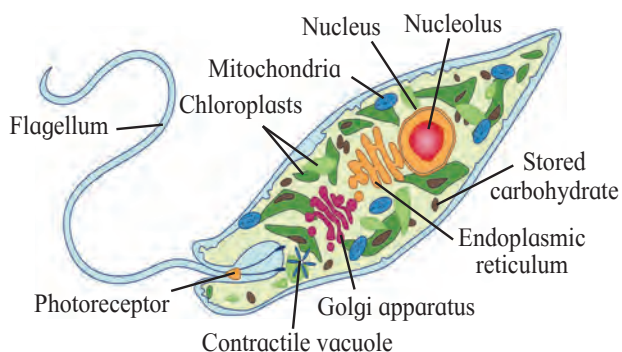
**Dinoflagellates :-** These are aquatic (mostly marine) and photosynthetic. The cell wall is made up of cellulosic stiff plates. They possess a pair of flagella. They have a wide range photosynthetic pigments, which can be yellow, green, brown, blue and red. *Gonyaulax* is dinoflagellate that is responsible for famous 'red tide'. It makes even sea appear red.



**Fig. 2.6 Gonyaulax**

**Euglenoids :-** They lack cell wall but have a tough covering of proteinaceous pellicle.

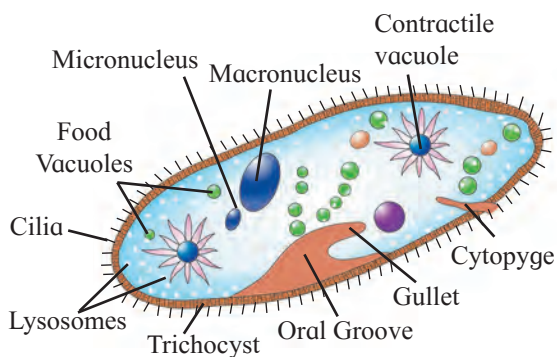
They possess two flagella, one short and other long. They behave as heterotrophs in absence of light but possess pigments, similar to that of higher plants, for photosynthesis.



**Fig. 2.7 Euglena**

**b. Animal-like Protists :-** They are also termed protozoans. They lack cell wall. They are heterotrophs. They are believed to be primitive animal forms. Amoeboid protozoans have pseudopodia as locomotory organs. *Amoeba* is free living form but *Entamoeba* is endoparasite and causes amoebic dysentery. Flagellated protozoans have flagella as locomotory organ. *Trypanosoma* is a common flagellated pathogen which causes sleeping sickness.

*Paramecium* is a ciliate protozoan having cilia for locomotion. In *Paramecium*, gullet (a cavity) opens on the cell surface. *Plasmodium* is a sporozoan protozoa. It causes malaria. It forms spores in one of its life stage.



**Fig. 2.8 Paramecium**

**c. Fungi like protists :-** They are commonly from the group **Myxomycetes**. These are saprophytic organisms found on decaying leaves. Their cells aggregate to form a large cell mass called plasmodium (not a malaria parasite). The spores produced by plasmodium are very tough and survive even very harsh conditions. e.g. *Stemonitis*

### 3. Kingdom Plantae:

The kingdom is dominated by autotrophs. It also includes some semi-autotrophic members, the insectivorous plants like Venus fly trap, pitcher plant, bladderwort, as well as heterotrophic parasitic members like *Cuscuta*. Members of this kingdom are multicellular, having eukaryotic cells containing chlorophyll. Cells have cell wall mostly made up of cellulose. Plants exhibit alternation of generation i.e., life cycle has two distinct phases. Kingdom Plantae is divided into two major groups *Cryptogamae* / Cryptogams and *Phanerogamae* / Phanerogams.

We will study this kingdom in detail in next chapter.

**4. Kingdom Fungi :** These are eukaryotic heterotrophs showing extracellular digestion. They are found in warm and humid places. They have simple body which may be unicellular or made up of long thread like structures called hyphae. Large fungi such as mushrooms have a compact mass of cells. Unicellular organisms have a protoplast with many nuclei. e.g. *Rhizopus*, *Saccharomyces* (Yeast-unicellular fungus).

Filamentous fungi consist of a body called mycellium in which hyphae are present. The hyphae may be with septa or without septa. They may be uni- or multinucleate. The non-septate multinucleate hyphae are called coenocytic hyphae. The cell wall in fungi is composed of chitin, a polysaccharide or fungal cellulose. The fungi exhibit hetrotrophic mode of nutrition. Mostly they are saprophytic, some are parasitic or predators. They reproduce sexually as well as asexually. Asexual reproduction takes place by fragmentation, fission and budding. Some fungi are symbiotic; either live with algae as lichens or as mycorrhiza in association with roots of higher plants.

They are useful as well as harmful. Mushrooms are consumed as food, yeast is used in bakery and breweries. *Penicillium*, a fungus, is well known for antibiotic production. Harmful fungi cause diseases in plants and animals, e.g. *Puccinia*.

The fungi are further classified on the basis of their structure, mode of spore formation and fruiting bodies as follows-

#### a. Phycomycetes :

These are commonly called **algal fungi**. Mycelium is made up of aseptate coenocytic hyphae. They commonly grow in moist and damp habitats, on decaying organic matter as well as in aquatic habitats or as parasites on plants.

e.g. *Mucor*, *Rhizopus* (bread mould), *Albugo* (parasitic fungus on mustard).

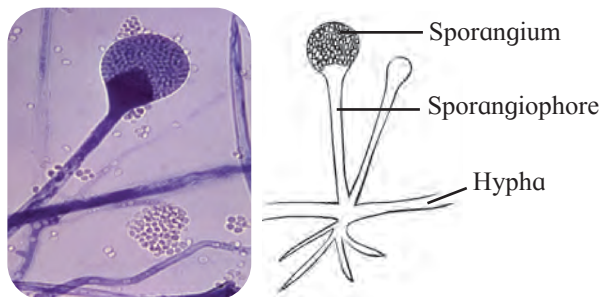


Fig. 2.9 *Mucor*

#### b. Ascomycetes :

These are called as **sac-fungi**. These fungi are mostly multicellular. Rarely unicellular varieties include yeast. The hyphae are branched and septate. Sac fungi can be decomposers, parasites or coprophilous (grow on dung). Morels and truffles are varieties of sac fungi that are consumed as delicacies. *Neurospora* is useful in genetic and biochemical assays.

Ex. *Aspergillus*, *Penicillium*, *Claviceps*, *Neurospora*, *Saccharomyces*.

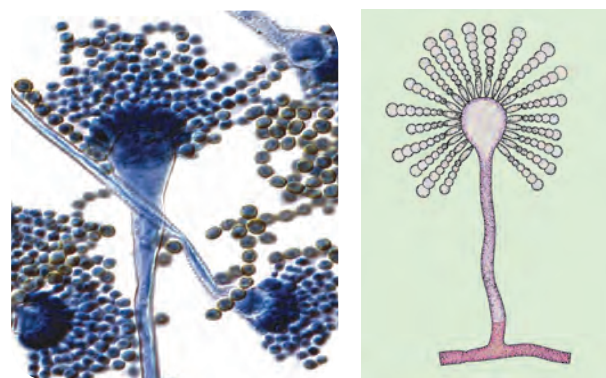


Fig. 2.10 *Aspergillus*

#### c. Basidiomycetes :

These are commonly called **club fungi**. They have branched, septate hyphae. e.g. *Agaricus* (mushrooms), *Ganoderma* (bracket fungi), *Ustilago* (smuts), *Puccinia* (rusts), etc.



Fig. 2.11 Mushroom

#### d. Deuteromycetes :

These are called imperfect fungi, which are known to reproduce only asexually. e.g. *Alternaria*, *Colletotrichum*.



Fig. 2.12 *Alternaria*



### Do you know ?

**Lichens :** Lichen is co-existence of algae and fungi for mutual benefit. Algal member, the phycobiont as it is called, mostly belongs to cyanobacteria (blue-green algae) or green algae. Fungal member is called mycobiont. They are excellent example of symbiosis. The algal component of lichens provides food to fungal partner while fungus provides shelter to alga and also the absorbed water and minerals to alga. The association is intense and it is difficult to identify them as separate living beings.

Though found in extreme environments like snow clad poles, lichens are sensitive to pollution. They are not found in polluted regions, hence are considered as pollution indicators. Lichens also play important role in soil formation by using specific acid productions.

**Lichen -  
e.g. *Parmelia***



### Can you tell?

1. Write a note on economic importance of fungi.
2. Why are fungi considered as heterotrophic organisms?
3. What are coenocytic hyphae?
4. Classify fungi into their types.

**5. Kingdom Animalia :** Members of this kingdom are heterotrophs; adapted to holozoic nutrition. Most of them have capacity of locomotion. They are multicellular eukaryotes where cells lack chlorophyll as well as cell wall. Growth is determinate (follow definite pattern).

In chapter four, we will study about Kingdom- Animalia and its further classification.



### Can you tell?

1. Differentiate between Plantae and Animalia.
2. How are fungi different from plants?
3. Have you seen any diseased plant in your farm?



### Do you know ?

New variety of Banana seedlings produced by tissue culture technique like 'Shrimanti', Basarai, G-9 are virus free varieties.

Viruses, Viroids are groups of acellular organisms that are not included in Whitaker's Five Kingdom classification.

### 2.14 Acellular organisms :

**a. Viruses :** Viruses were named so by Louis Pasteur; considering the meaning, Venom or poison. These obligate parasites were given the name 'virus' by M. J. Beijerinck, after observation that they were able to migrate in an agar gel. Thus, being infectious soluble agent, he called the filtrate as 'contagium vivum fluidum'. It was scientist Stanley who demonstrated that viruses are inert when outside the host cell and can be crystallised. They are made up of proteins.

Viruses lack their own cell machinery. They have protein coat (capsid) around nucleic acid strand, thus considered to be acellular organisms. Viruses are inactive outside a host cell; but once they enter their specific host cell, they take charge of cellular machinery of host



cell and duplicate themselves. Viruses thus can be called infectious nucleoprotein particles.

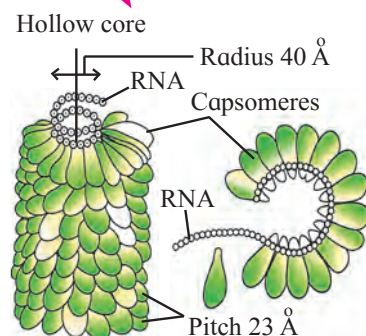
### Types of viruses :

As per genetic material, viruses are grouped as DNA or RNA viruses.



#### Do you know ?

Viruses have either DNA or RNA as their genetic material but never DNA as well as RNA together at a time.

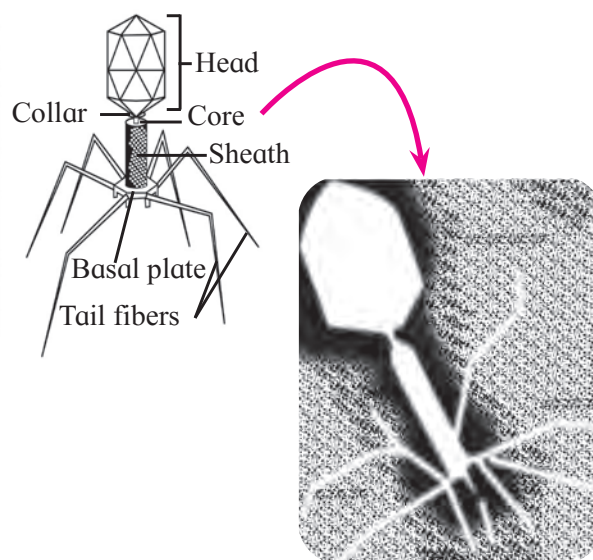


**Fig. 2.13 Tobacco mosaic virus (TMV)**

Protein coat called capsid is made up of smaller units, the capsomeres. Capsomeres are arranged in polyhedral or helical forms. Capsid protects genetic material.

Genetic material in viruses is usually either single-stranded RNA (very rarely double stranded RNA) or double stranded DNA (rarely single stranded DNA). Viruses that infect bacterial cells are called bacteriophages which normally have double-stranded DNA.

Viruses cause disorders like leaf curling, yellowing, mosaic formation etc. in plants. You have heard of foot and mouth disease in animals or swine flu which are viral diseases. Small pox, mumps, herpes to common cold, viruses are the causative agents of many diseases in humans. The list includes AIDS too!



**Fig. 2.14 Bacteriophage**

**b. Viroids :** Potato spindle tuber disease was found to be caused by single stranded RNA which lacks protein coat. T. O. Diener in 1971 reported that this is low molecular weight RNA and smaller in size than viruses. These infectious RNA strands are called viroids.



#### Can you tell?

1. Why are viruses called infectious nucleoproteins?
2. Describe genetic material in plant and animal viruses as well as in bacteriophages.
3. Differentiate between viruses and viroids.



#### Internet my friend

**Prions :** In modern medicine, certain infectious neurological diseases were found to be transmitted by abnormally folded proteins. These proteins are called prions. The word prion comes from 'proteinaceous infectious particle'. e.g. mad cow disease in cattle, Jacob's disease in human. Find more information about prions.



**Observe and Discuss**

Complete the following table on the basis of previous knowledge.

Characters	Monera	Protista	Fungi	Plantae	Animalia
Cell type	Prokaryotic	Eukaryotic	Eukaryotic	Eukaryotic	Eukaryotic
Cell wall	-----	Present in some organisms	.....	Present (cellulose)	.....
Nuclear membrane	Absent	Present	Present	.....	Present
Body organization	Unicellular	.....	Multicellular/ loose tissue	Tissue /organ	T i s s u e / organ /system
Mode of nutrition	.....	<b>Autotrophic</b> Photosynthetic <b>Heterotrophic</b>	.....	<b>Autotrophic</b> (Photosynthetic)	-----
Ecological role	Decomposers	.....	Decomposers	.....	Consumers

**Do Yourself**

Complete the following table through collecting information about sunflower, tiger with characteristic features.

Sunflower

Category	Taxon	Characteristics
Kingdom		

Tiger

Category	Taxon	Characteristics
Kingdom		



## Exercise

### 1. Choose correct option

- A. Which of the following shows single stranded RNA and lacks protein coat?  
 a. Bacteriophage      b. Plant virus  
 c. Viroid                d. Animal virus
- B. Causative agent of red tide is \_\_\_\_\_  
 a. Dinoflagellate      b. Euglenoid  
 c. Chrysophyte        d. Lichen
- C. Select odd one out for Heterotrophic bacteria.  
 a. Nitrogen fixing bacteria  
 b. Lactobacilli  
 c. Methanogens  
 d. Cyanobacteria
- D. *Paramecium* : Ciliated Protist  
*Plasmodium* : \_\_\_\_\_  
 a. Amoeboid protozoan    b. Ciliophora  
 c. Flagellate protozoan    d. Sporozoan

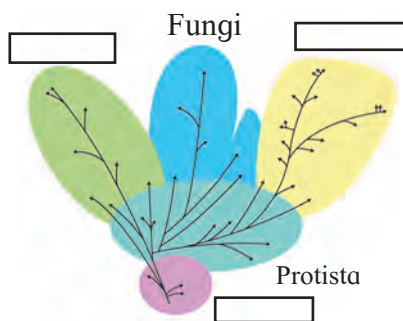
### 2. Answer the following

- A. What are the salient features of monera?  
 B. What will be the shape of bacillus and coccus type of bacteria?  
 C. Why is binomial nomenclature important?

### 3. Write short notes

- A. Useful and harmful bacteria.  
 B. Five Kingdom system  
 C. Useful Fungi

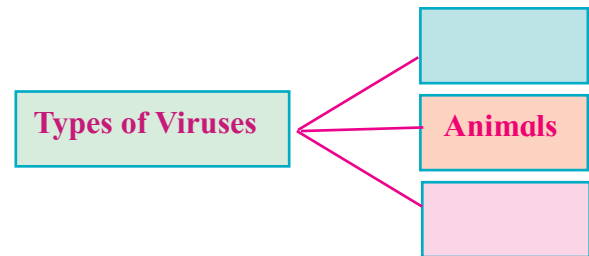
### 4. Complete tree diagram in detail



### 5. Draw neat labelled diagrams

- A. *Paramecium*  
 B. *Euglena*  
 C. TMV

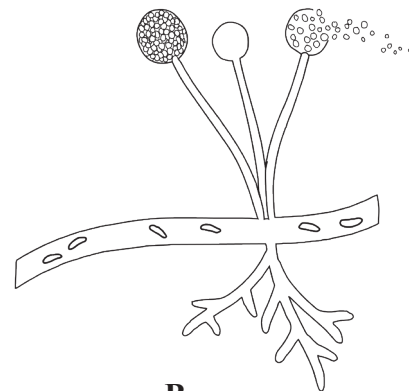
### 6. Complete chart and explain in your words



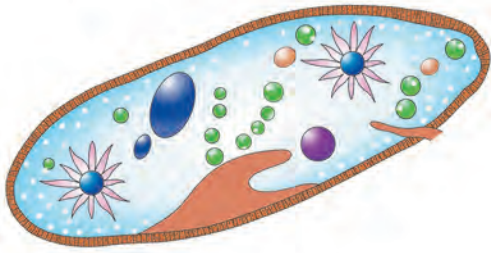
### 7. Identify the following diagrams, label them and write detail information in your words



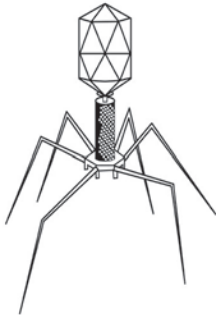
A



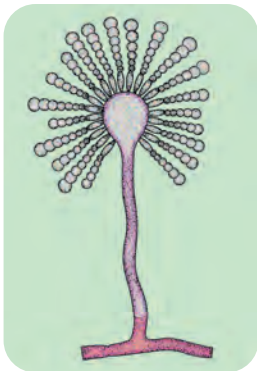
B



C



D



E



F

8. The scientific name of sunflower is given below. Identify the correctly written name.

- A. *Helianthus annuus L.*
- B. *Helianthus Annuus l.*

9. Match the following.

Kingdom	Example
i. Monera	a. <i>Riccia</i>
ii. Protista	b. Cyanobacteria
iii. Plantae	c. <i>Rhizopus</i>
iv. Fungi	d. Diatoms

10. Complete the following

- A. Plant-like Protista -
- B.  - *Entamoeba*

**Practical / Project :**

1. Make a group of students. Observe living organisms in your school/college campus and try to write their characters with respect to habit, habitat, mode of nutrition, growth- determinate or indeterminate, type of reproduction - vegetative reproduction - asexual reproduction - Sexual reproduction.

With the help of similarity and dissimilarity, try to classify organisms into different categories. Similar work should implement for animal group.

2. Find out types of lichens and its economic importance.

## 3. Kingdom Plantae



### Can you recall?

1. Why do we call plants as producers on land ?
2. What are differences between sub-kingdoms Cryptogamae and Phanerogamae?
3. Differentiate between Thallophytes and Bryophytes.
4. Give any two examples of Pteridophyta.

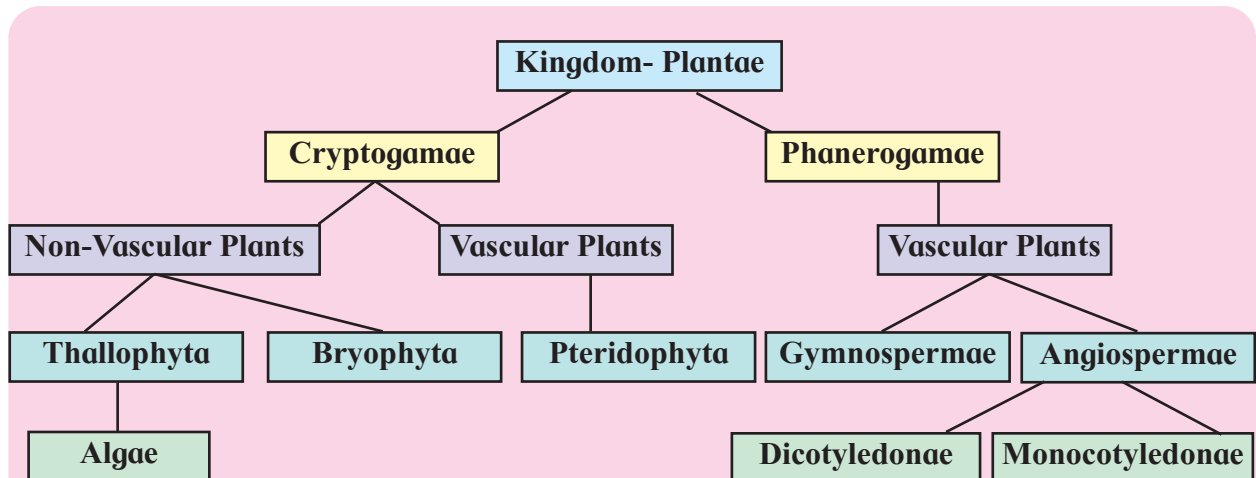
### 3.1 Kingdom plantae :

In earlier chapter, we have studied different aspects of classification.

Kingdom Plantae is further classified on the basis of characteristics like absence or presence of seeds, vascular tissues, differentiation of plant body, etc.

- Phanerogamae are commonly called seed producing plants. They produce special reproductive structures that are visible (Phaneros – visible)
- Cryptogamae are spore producing plants and do not produce seeds and flowers. They reproduce sexually by gametes but sex organs are concealed (kryptos : hidden, gamos : marriage).

**Classification of Kingdom Plantae is represented as follows :**



**Chart 3.1 Classification of Kingdom Plantae**



### Observe and Discuss

Collect different water samples of fresh water. Mount them on a glass slide and observe under a compound microscope. Try to identify the organisms which are visible under it.

### 3.2 Salient features of major plant groups under Cryptogamae :

**A. Division : Thallophyta** - Members are mostly aquatic, few grow on other plants as epiphytes. Some grow symbiotically and epizoic i.e. growing or living non-parasitically on the exterior of living organisms. Aquatic algae grow in marine or fresh water. Most of them are free living while some are symbiotic.

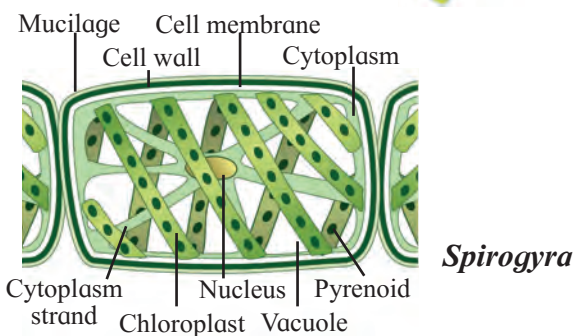
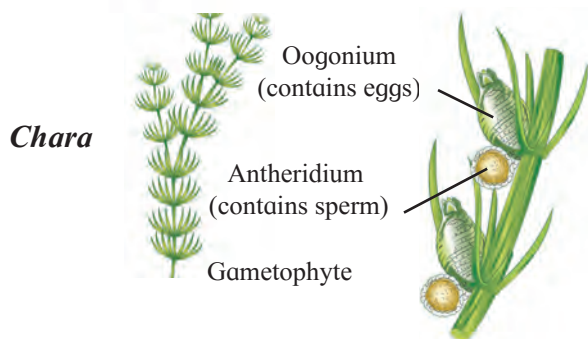
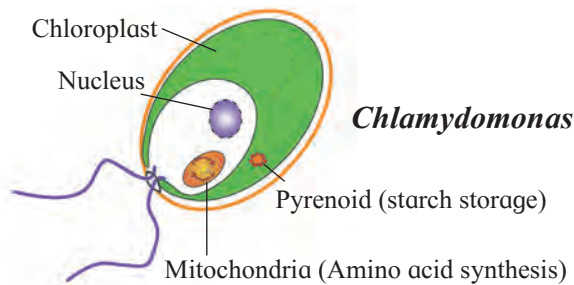
Plant body is thalloid i.e. undifferentiated into root, stem and leaves. They may be small, unicellular, microscopic like *Chlorella* (non-motile), *Chlamydomonas* (motile). They can be multicellular, unbranched, filamentous like *Spirogyra* or branched, filamentous like *Chara*. *Sargassum*, a huge macroscopic sea weed which measures more than 60 meters in length is also an alga.

The algal cell wall contains either polysaccharides like cellulose / glucose or a variety of proteins or both. Reserve food is in the form of starch and its other forms. Reproduction takes place by vegetative, asexual and sexual ways. The life cycle shows phenomenon of alternation of generation, dominant haploid and reduced diploid phases. Algae are classified as per its pigments like chlorophyll, xanthophylls and phycobilin.

**a. Chlorophyceae (green algae) :**

These are mostly fresh water (few brackish water and marine) forms. Plant body is unicellular, colonial, filamentous. Cell wall contains cellulose.

Chloroplasts are of various shapes like discoid, plate-like, reticulate, cup-shaped, ribbon-shaped or spiral with chlorophyll a and b. The stored food is in the form of true starch.



**Fig. 3.2 Chlorophyceae**

Pyrenoids are located on Chloroplast. Members are rich in protein, so used as food; used even by space travellers. e.g. *Chlorella*, *Chlamydomonas*, *Spirogyra*, *Chara*, *Volvox*, *Ulothrix* etc.



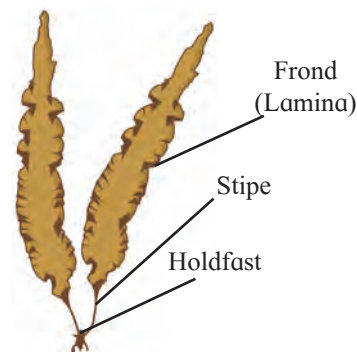
**Internet my friend**

1. Make a list of green algae with their characteristic shape of chloroplast.
2. Enlist the forms of filamentous algae.
3. Write different pigments found algae.

**b. Phaeophyceae (Brown algae) :**

**Plant body :** Mostly marine, rarely fresh water. Simple branched / filamentous (e.g. *Ectocarpus*) / profusely branched (*Petalonia*).

Cell wall has cellulose, fucans and algin. Photosynthetic pigments like chlorophyll-a, -c and fucoxanthin are present. Mannitol, laminarin and starch are the stored food materials. Body is usually differentiated into **holdfast**, stalk called **stipe** and leaf-like photosynthetic organ called **frond**. Many species of marine algae are used as food. e.g. *Laminaria*, *Sargassum*. Some species are used for production of hydrocolloids. e.g. *Ectocarpus*, *Fucus*, etc.



*Sargassum*

*Laminaria*



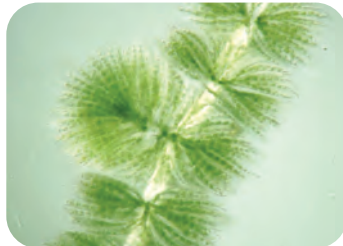
*Fucus*

**Fig. 3.3 Phaeophyceae**

### c. Rhodophyceae (Red algae) :

**Plant body** These are found in marine as well as fresh water on the surface, deep sea and brakish water. Plant body is thalloid. Cells contain chlorophyll a, d and phycoerythrin. Cell wall is made up of cellulose and pectin glued with other carbohydrates. Stored food is in the form of Floridean starch. Commercially important agar-agar which is used as solidifying agent in tissue culture medium, is obtained from red algae. e.g. *Chondrus*, *Batrachospermum* *Porphyra*, *Gelidium* , *Gracillaria*, *Polysiphonia*, etc.

*Batrachospermum*



*Gracillaria*

*Polysiphonia*



**Fig. 3.4 Rhodophyceae**



#### Internet my friend

1. Economic importance of algae.
2. Role of algae in environment.
3. Different forms of green, red, brown and blue green algae.



#### Do you know ?

Brown algae- kelps may grow up to 100 meters in height. Find out more information about Sargasso sea.



#### Can you tell?

1. What are the three major groups of Cryptogams ?
2. Name the accessory pigments of algae.
3. Give salient features of algae
4. Differentiate between Chlorophyceae and Phaeophyceae.
5. Enlist examples of Chlorophyceae and Rhodophyceae.



#### Observe and Discuss

You may have seen *Funaria* plant in rainy season. Why is it called amphibious plant?

### B. Bryophyta

#### (Bryon : moss ; phyton : plant)

Bryophytes are mostly terrestrial plants. They are found in moist shady places. But they need badly water for fertilization and completion of their life cycle. Hence they are called ‘amphibious plants’. They include approximately 960 genera and about 25,000 species.

Life cycle of Bryophytes shows sporophytic and gametophytic stages. Vegetative plant body is thalloid or leafy which represents gametophytic generation. Spore producing capsule represents sporophytic generation.

Bryophytes have root-like structures called **rhizoids**. Rhizoids are unicellular in liverworts while multicellular in mosses. Rhizoids absorb water and minerals and also help in fixation of thallus on the substratum.

Bryophytes are divided into two groups : liverworts and mosses.

#### a. Liverworts (Hepaticae) :

These are lower members of Bryophyta. These are primitive group of Bryophytes. Gametophyte possesses flat plant body called **thallus**. The thallus is green, dorsiventral, prostrate with unicellular rhizoids. e.g. *Riccia*, *Marchantia*.

**Hornworts (Anthocerotae)** - These members possess flattened thallus. The thallus produces horny structures which are called sporophytes hence the name hornworts. e.g. *Anthoceros*.

**b. Mosses (Musci) :**

These are advanced members of Bryophyta which possess erect plant body.

Gametophytic phase of the life cycle includes two stages namely; **protonema** stage and **leafy** stage. The protonema is prostrate green, branched and filamentous (it is also called juvenile gametophyte). It bears many buds. Leafy stage is produced from each bud. Thus protonema helps in the vegetative propagation. The leafy stage has erect, slender stem like (Cauloid) main axis bearing spirally arranged leaf like structures (Phylloid). It is fixed in soil by multicellular branched rhizoids. This stage bears sex organs. Vegetative reproduction takes place by fragmentation and budding in secondary protonema.

e.g. *Funaria*, *Polytrichum*, *Sphagnum*, etc.



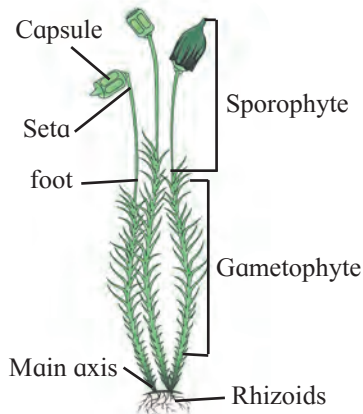
*Riccia* (Liverworts)



*Anthoceros*



*Funaria*



**Fig. 3.5 Mosses**

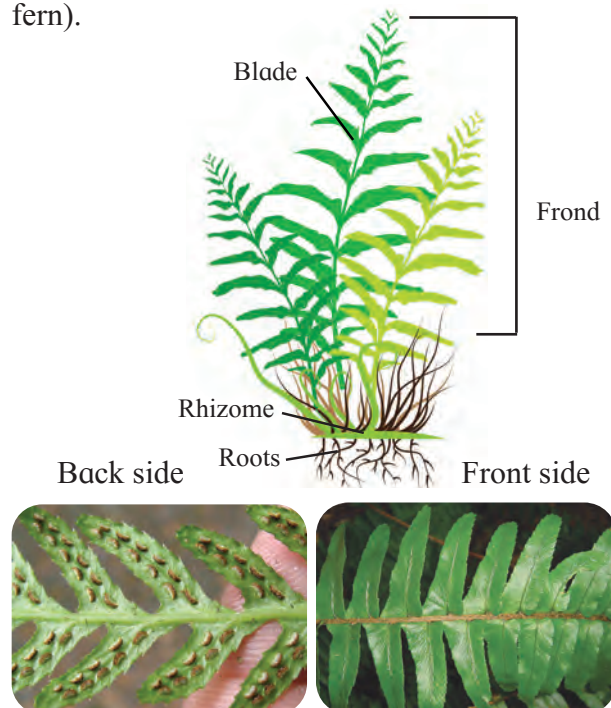
**Economic importance -**

Some mosses provide food for herbivorous mammals, birds, etc. Species of *Sphagnum*, a moss; provides peat used as fuel. Mosses are also used as packing material for transport of living materials because they have significant water holding capacity. Just like lichens, mosses are the first living beings to grow on rocks. They decompose rocks to form soil and make them suitable for growth of higher plants. Dense mats of mosses help in prevention of soil erosion, thus act as soil binders.

**C. Pteridophyta**

(Pteron : feather, phyton : plant)

Evolutionarily, Pteridophytes are the first vascular and true land plants. Hence considered as the first successful terrestrial plants with true roots, stem and leaves. These plants have a primitive conducting system and they are the only Cryptogams with vascular tissues. The late Paleozoic era is regarded as the age of Pteridophytes. The group has about 400 genera and 11,000 species. The plants consist of pinnate (feather like) leaves. Leaves may be small called **microphylls** (e.g. *Selaginella*) or large called **macrophylls** (e.g. *Nephrolepis* / fern).



**Fig. 3.6 Nephrolepis (Fern)**





### Observe and Discuss

You may have seen the various plants which do not bear flowers, fruits and seeds but they have well developed root, stem and leaves. Discuss.

Pteridophytes grow in moist and shady places. Pteridophytes show sporophytic and gametophytic stages in life cycle. e.g. Ferns, Horsetail. Some are aquatic (*Azolla*, *Marsilea*), xerophytic (*Equisetum*) and epiphytic (*Lycopodium*).

Pteridophytes show heteromorphic alternation of generations in which the sporophyte is diploid, dominant, autotrophic and independent. It is differentiated into root, stem and leaves. The primary root is short lived and soon replaced by adventitious roots while the stem may be aerial or underground. Leaves may be scaly (*Equisetum*), simple and sessile (*Lycopodium*) or large and pinnately compound (*Nephrolepis* / Ferns).

In these members, xylem consists of only tracheids and Phloem consists of only sieve cells. Secondary growth is not seen in Pteridophytes due to absence of cambium.

Pteridophytes are classified as - Psilopsida- (*Psilotum*), Lycopsida - (*Selaginella* and *Lycopodium*), Sphenopsida - (*Equisetum*) and Pteropsida - (*Dryopteris*, *Pteris* and *Adiantum*)

**Economic importance -** Pteridophytes are Used for medicinal purpose and as soil binders. Many varieties are grown as ornamental plants.



### Can you tell?

1. Distinguish between Bryophyta and Pteridophyta.
2. Why Bryophyta are called amphibians of Plant Kingdom?
3. Pteridophytes are also known as vascular Cryptogams - Justify.
4. Give one example of aquatic and xerophytic Pteridophytes.



### Observe and Discuss

Observe all garden plants like *Cycas*, *Thuja*, *Pinus*, Sunflower, *Canna* and compare them. Note similarities and dissimilarities among them. Which differences did you notice between Gymnosperms and Angiosperms?

### 3.3 Salient features of major plant groups under Phanerogamae:

#### A. Gymnospermae

(Gymnos : naked, sperma : seed) :-

There are about 70 genera and 1000 living species of Gymnosperms in world. In India group is represented by 16 genera and 53 species.

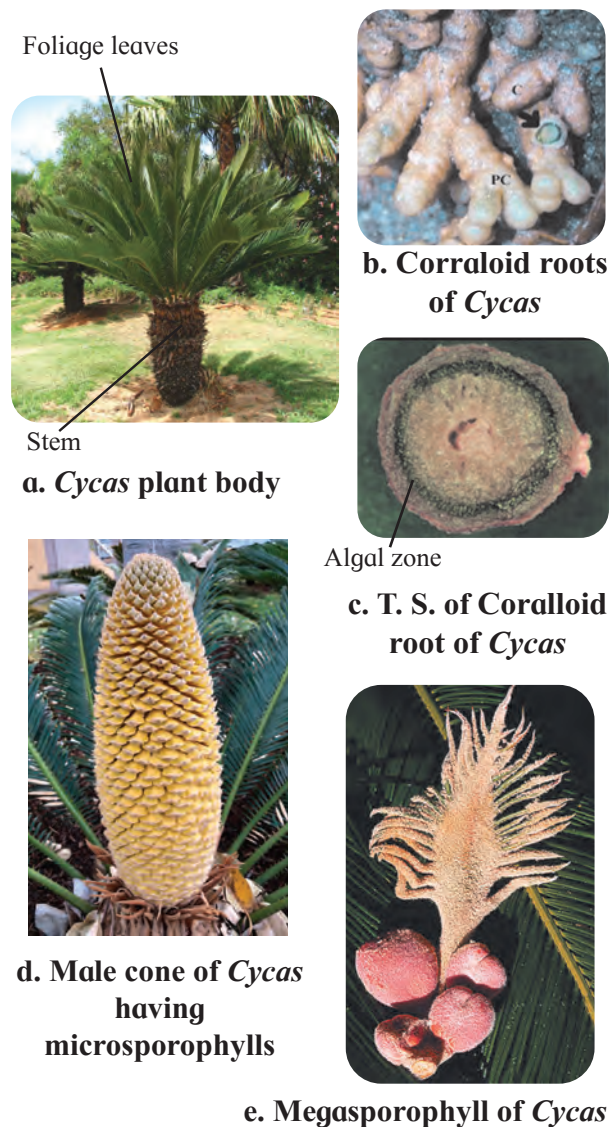


Fig. 3.7 *Cycas* plant details

Most of the Gymnosperms are evergreen, shrubs or woody trees. These are primitive group of flowering plants producing naked seeds. They are vascular plants predominantly having Xylem with tracheids and Phloem with sieve cells.

The plant body is sporophyte. It is differentiated into root, stem and leaves. The root system is tap root type. In some, roots form symbiotic association with other life forms. Coralloid roots of *Cycas*, show association with blue green algae and roots of *Pinus* show association with endophytic fungi called mycorrhizae.

In Gymnosperms, stem is mostly erect, aerial, solid and cylindrical. Secondary growth is seen in Gymnosperms due to presence of cambium. In *Cycas* it is usually unbranched, while in conifers it is branched. The leaves are **dimorphic**. The foliage leaves are green, simple needle like or pinnately compound, where as scale leaves are small, membranous and brown. Spores are produced by microsporophyll (Male) and megasporophyll (Female).

**Economic importance -** *Cycas* is grown as ornamental plant. *Pinus* is used as source of pine wood, turpentine oil and pine resin.



**Fig. 3.8** *Pinus* tree with cones



### Do you know ?

Gymnosperms like *Ginkgo biloba* is called living fossil. It is because the plant is found in living as well as fossil form and the number of fossil forms is much more than the living forms.

Gymnosperms vary in their size. e.g. *Sequoia sempervirens* is the tallest living plant in the world. It is commonly called coast red wood of California. The height of the plant is about 366 feet. *Taxodium mucronatum* has a girth of about 125 feet. *Zamia pygmaea* is the smallest Gymnosperms and is about 25 cms. only.



### Try this

Study the leaves of *Hibiscus*, Peepal, *Canna*, Grass and Tulsi. Classify them as Monocot and Dicot.



### Can you recall?

1. What are the salient features of Angiospermae?
2. What is double fertilization ?
3. Explain in brief two classes of Angiospermae? Draw and label one example of each class.

## **B. Angiospermae (Angios : enclosed : vessel, Sperma : seed)**

Angiosperms are the most advanced group of flowering plants. In these plants the seeds are enclosed within the fruit i.e. ovary. Angiosperms is a group of highly evolved plants, primarily adapted to terrestrial habitat. They vary in size.

Angiosperms show heteromorphic alternation of generation in which the sporophyte is diploid, dominant, autotrophic and independent. The gametophytes (male or female) are haploid, reduced, parasitic and concealed in the sporophyte.

Angiosperms are heterosporous. Microspores (commonly called pollens) are formed in microsporangia (of anthers). They develop in highly specialized microsporophylls or **stamens** while megaspores are formed in megasporangia (or ovules) borne on highly specialized megasporophyll called **carpel**.

Besides the essential whorls of microsporophylls (Androecium) and megasporophylls (Gynoecium), there are accessory whorls namely calyx (sepals) and corolla (petals) arranged together to form flowers.



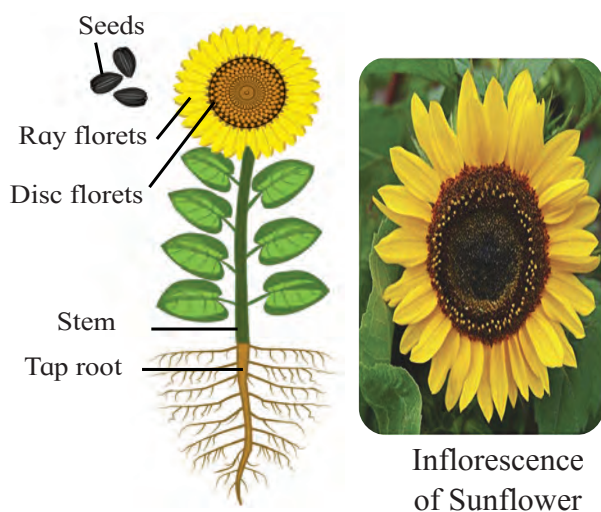
### Do you know ?

*Wolffia* is the smallest Angiosperm, 1mm in size and *Eucalyptus* grows to over 100 meters high.

**Angiosperms are subdivided into two classes:**

**a. Dicotyledonae :** These plants have two cotyledons in their embryo. They have a tap root system and the stem is branched. Leaves show reticulate venation while the flowers show tetra- or pentamerous symmetry.

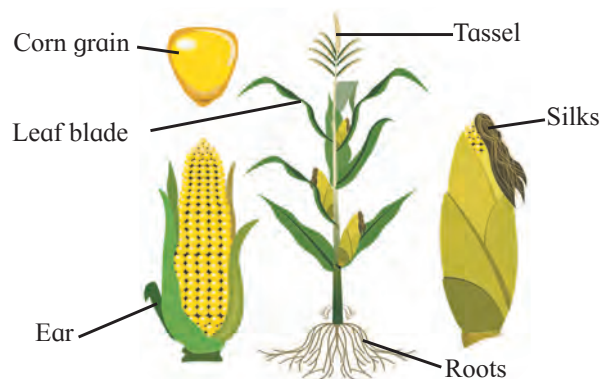
Vascular bundles are conjoint, collateral and open type. Cambium is present between Xylem and Phloem for secondary growth. In Dicots, secondary growth is commonly found. e.g. *Helianthus annuus* (sunflower), *Hibiscus rosa-sinensis* (China rose).



**Fig. 3.9 *Helianthus annuus* (Sunflower)**

**a. Monocotyledonae :** These plants have single cotyledon in their embryo. They have adventitious root system and stem is rarely branched. Leaves generally have sheathing leaf base and parallel venation while the flowers are generally trimerous.

The vascular bundles are conjoint, collateral and closed type. In Monocots, except few plants secondary growth is absent. e.g. *Zea mays* (Maize), *Sorghum vulgare* (Jowar).



**Fig. 3.10 *Zea mays* (Maize)**



### Can you tell?

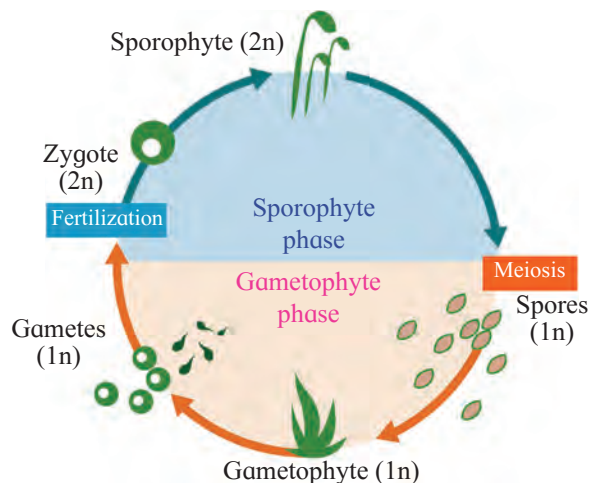
1. Give general characters of Gymnospermae and Angiospermae.
2. Distinguish between Dicotyledonae and Monocotyledonae.
3. Why do Dicots show secondary growth while Monocots don't?

### 3.4 Plant life cycle and alternation of generations:

Life cycle of a plant includes two phases or distinct generations namely sporophyte (diploid :  $2n$ ) and gametophyte (haploid :  $n$ ). Some special diploid cells of sporophyte divide by **meiosis** to produce haploid cells. These haploid cells divide mitotically to give rise to gametophyte. The gametophyte produces separately male and female gametes which fuse during fertilization to produce diploid **zygote**. It divides by mitosis to form **diploid sporophyte**. The sporophytic and gametophytic generations generally occur alternately in the life cycle of a plant. This phenomenon is called **alternation of generations**.

Distinct alternation of these two generations is observed in Bryophytes and Pteridophytes. In Gymnosperms and Angiosperms, gametophyte is much reduced and exists within sporophyte. In algae, based upon the nature of dominant phase in life cycle, it is called haplontic, diplontic or haplo-diplontic life cycle.

In Bryophytes haploid gametophyte is dominant. It is photosynthetic, independent thalloid or erect phase. Sporophyte is short lived, multicellular and depends totally or partially on gametophyte for nutrition and anchorage. Whereas in Pteridophytes, sporophyte is dominant, independent and vascular plant body. Haploid multicellular independent, non vascular gametophyte is generally autotrophic and short lived. It alternates with Sporophyte.

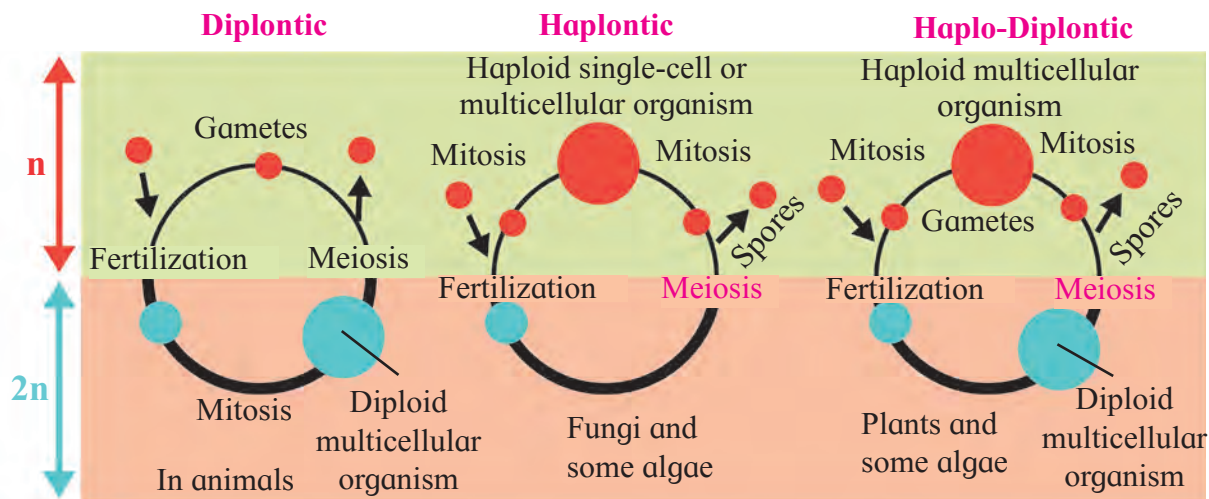


**Fig. 3.11 Alternation of generation**



**Can you tell?**

1. What is alternation of generations?
2. Which phase is dominant in the life cycle of Bryophyta and Pteridophyta ?



**Fig. 3.12 Types of life cycle**

**Diplontic :**

Here mitotic divisions occurs only in diploid cells. Gametes formed through meiosis are haploid in nature. The diploid zygote divide mitotically. In this process production of multicellular diploid organism or in the production of many diploid single cells takes place. E.g. Animals.

**Haplontic :**

Here mitosis occurs in haploid cells. It results in the formation of single haploid cells or a multicellular haploid organism. These forms produce the gametes through mitosis. Zygote is formed after fertilization. This cell is the only diploid cell in the entire life cycle of the organism. Thus the same zygotic cell later undergoes **meiosis**. E.g. Some Algae and Fungi.

**Haplo-diplontic :**

Here mitosis occur in both diploid and haploid cells. These organisms undergo through a phase in which they are multicellular and haploid (the gametophyte), and a phase in which they are multicellular and diploid (the sporophyte). E.g. Land plants and in many algae.



## Exercise

### 1. Choose correct option

- A. Which is the dominant phase in Pteridophytes?  
 a. Capsule                      b. Gametophyte  
 c. Sporophyte                  d. Embryo
- B. The tallest living gymnosperm among the following is .....  
 a. *Sequoia sempervirens*  
 b. *Taxodium mucronatum*  
 c. *Zamia pygmaea*  
 d. *Ginkgo biloba*
- C. In Bryophytes .....  
 a. Sporophyte and gametophyte generations are independent  
 b. Sporophyte is partially dependent upon gametophyte  
 c. Gametophyte is dependent upon Sporophyte  
 d. Inconspicuous gametophyte is present
- D. A characteristic of Angiosperm is .....  
 a. Collateral vascular bundles  
 b. Radial vascular bundles  
 c. Seed formation  
 d. Double fertilization
- E. Angiosperms differ from Gymnosperms in having .....  
 a. Vessels in wood  
 b. Autotrophic Mode of nutrition  
 c. Siphonogamy  
 d. Enclosed seed

**2. How you place the pea, jawar and fern at its proper systematic position? Draw a flow chart of each.**

### 3. Complete the following table

Groups of algae	Chlorophyceae	Phaeophyceae	Rhodophyceae
1. Stored food	Starch		
2. Cell Wall		Cellulose and algin	
3. Major pigments			Chl- a, d and Phycoerythrin

### 4. Differentiate between Dicotyledonae and Monocotyledonae based on the following characters

- a. Type of roots  
 b. Venation in the leaves  
 c. Symmetry of flower

### 5. Answer the following questions

- A. We observe that land becomes barren soon after monsoon. But in the next monsoon it flourishes again with varieties we observed in season earlier. How you think it takes place?
- B. Fern is a vascular plant. Yet it is not considered a Phanerogams. Why?
- C. *Chlamydomonas* is microscopic whereas *Sargassum* is macroscopic, both are algae. Which characters of these plants includes them in one group?

**6. Girth of a Maize plant does not increase over a period of time. Justify**

**7. Radha observed a plant in rainy season on the compound wall of her school. The plant did not have true roots but rootlike structures were present. To which group the plant may belong?**

### 8. Draw neat labelled diagrams

- A. *Spirogyra*  
 B. *Chlamydomonas*  
 C. *Funaria*  
 D. *Nephrolepis*  
 E. Haplontic and haplodiplontic life cycle

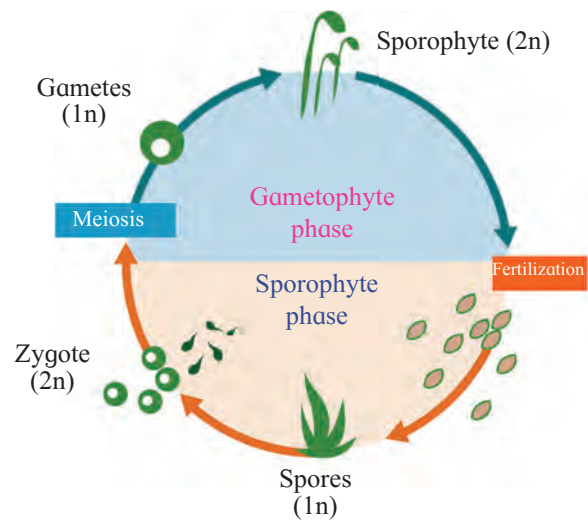
9. Identify the plant groups on the basis of following features.

- A. Seed producing plants
- B. Spore producing plants
- C. Plant body undifferentiated into Root, Stem and leaves
- D. Plant need water for fertilization
- E. First vascular plants

**Practical / Project :**

1. Study the *Nephrolepis* plant in detail.
2. Study the coralloid roots, scale leaf and megasporophyll of *Cycas* in detail.

10. Observe the following diagram. Correct it and write the information in your words.



## 4. Kingdom Animalia



### Can you recall?

1. What is the basis for classification ?
2. Who proposed Five Kingdom classification system?
3. What is the need and importance of classification?

You are familiar with animals, their general characteristics and great diversity observed in this group. Let us learn about how this diverse group is classified systematically.

#### 4.1 Criteria used for animal classification:

Grades of organization - Cellular, Cell-Tissue, Tissue-Organ, Body Symmetry- Assymetry, Radial Symmetry, Bilateral Symmetry, Body Cavity - Acoelomate, Pseudocoelomate, Coelomate. Germ Layers -Diploblastic, Triploblastic. Segmentation- Unsegmented, Segmented.

#### 4.2 Animal body plan :

**a. Cell aggregate plan :** In this body plan, cells do not form tissues or organs. Their is minimal differentiation and division of labour among cells. It is found in porifera.

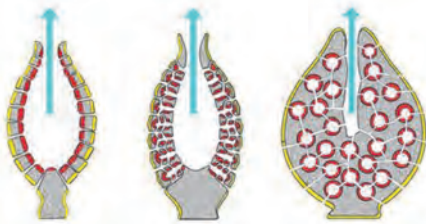


Fig. 4.1 Sponge

**b. Blind sac body plan :** In this body plan, body is like a sac with single opening. Digestion is carried out in this sac-like structure where ingestion and egestion takes place through same opening. e.g. Members of Phylum Cnidaria.



Fig. 4.2 Hydra

**c. Tube within tube body plan :** Digestive system is present in tube-like body cavity. Mouth and anus are present at two separate ends of digestive system. Annelida onwards all phyla show this type of body plan.

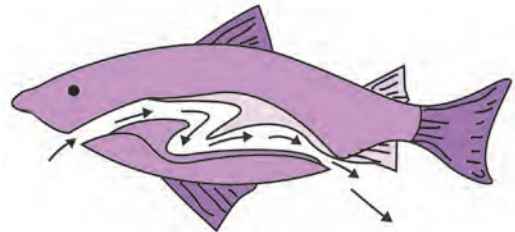
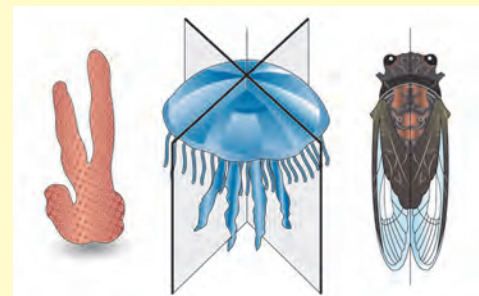
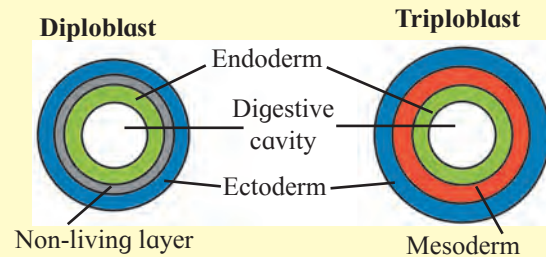


Fig. 4.3 Fish



### Observe and Discuss

Observe the diagram given below and discuss the criterias of classification.



Asymmetry Radial Bilateral

### Types of Symmetry

#### 4.3 Animal Classification :

##### 1. Phylum : Porifera

(pori-pores; feron-bearing)

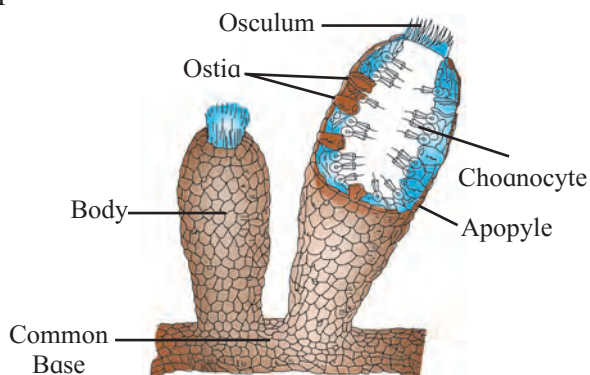
e.g. *Scypha*, *Euspongia* (Bath sponge), *Euplectella* (Venus' flower basket)

These are aquatic animals, most of them are marine and few are fresh water. They are also called 'sponges'.

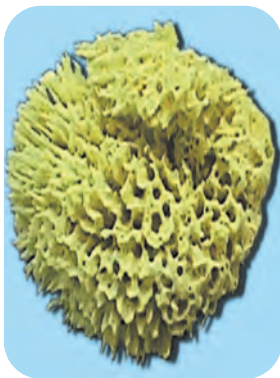
Most of them have asymmetrical body. Body of these animals consists of many cells with little division of labour. Hence their body is considered as a colony of different types of cells.

These are sedentary animals. On their body, they bear numerous minute pores called 'ostia' through which water enters in the body cavity- spongocoel. Water leaves the body through single large opening called 'osculum'.

Water is circulated in the body through the 'canal system'. During its circulation, cells of the animal body absorb food, exchange respiratory gases and release excretory products.



a. *Sycon*



b. *Euspongia*



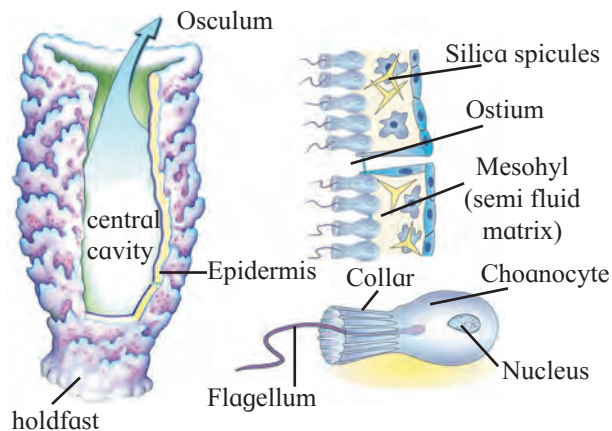
c. *Euplectella*

**Fig. 4.4 Animals - Porifera**

Spongocoel is lined by special flagellated cells called 'choanocytes' or 'collar cells'. Beating of flagella creates water current.

Body of these animals is supported by calcareous or siliceous 'spicules' or proteinaceous 'spongin fibers'.

They reproduce asexually as well as sexually. Asexual reproduction is performed by fragmentation and gemmule formation. These animals have ability of regeneration. Sexual reproduction is performed by formation of gametes. Fertilization is internal. Development takes place through indirect larval stage.



**Fig. 4.5 Typical Sponge body**



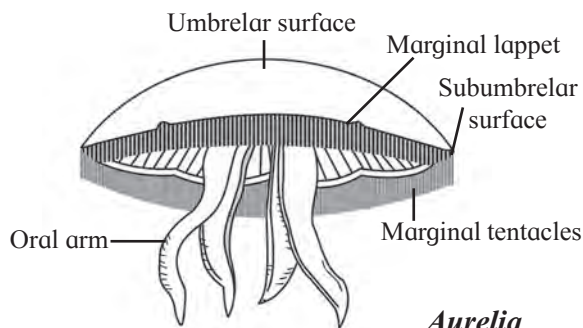
**Internet my friend**

Which are the larval stages of Porifera?

## 2. Phylum : Cnidaria

e.g. *Hydra*, *Aurelia* (Jelly fish), *Physalia* (Portuguese man-of-war), *Adamsia* (sea anemone), *Diploria* (Brain coral), *Gorgonia* (sea fan).

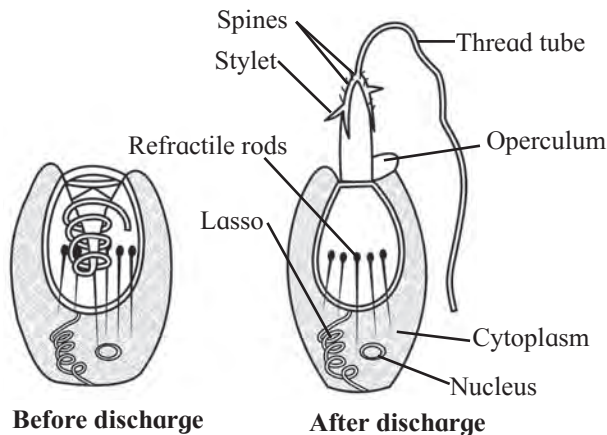
They are aquatic, mostly marine and few are fresh water forms. They are sessile or free swimming. They show radial symmetry and are diploblastic with blind-sac body plan. Animals exhibit two body forms. Polyp is cylindrical form (*Hydra*) and medusa is umbrella-like (*Aurelia* - Jelly fish).



**Fig. 4.6 Animal of Cnidaria**



Body cavity is meant for circulation as well as digestion. Hence called gastrovascular cavity or coelenteron. Tentacles bear cnidoblasts or stinging cells which are meant for anchorage, offence and defence. Cnidarians reproduce both asexually and sexually. Asexual reproduction takes place by budding and regeneration. Sexual reproduction takes place by gamete formation. They exhibit alternation of polypoid generation with medusoid generation. This phenomenon is called metagenesis i.e. polyps produce medusae asexually and medusae produce polyps sexually. (e.g. *Obelia*)



**Fig. 4.7 Cnidoblast**



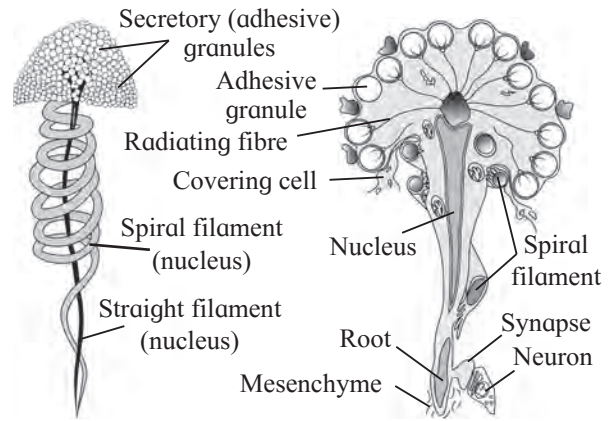
**Find out**

Information about coral reef and sea fan.

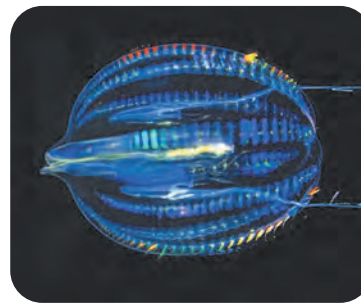
**3. Phylum : Ctenophora**

e.g. *Pleurobrachia*, *Ctenoplana*.

These are commonly called comb jellies or sea walnuts. These are exclusively marine, free swimming animals. Body is diploblastic, radially symmetrical with blind-sac body plan. Animals have tissue-level organisation. Locomotion is carried out by eight rows of ciliated comb plates. Characteristic feature of ctenophores is bioluminescence. Like cnidarians, ctenophores also exhibit extra and intracellular digestion. Reproduction is sexual with indirect development. Cnidoblasts are absent hence these are called acnidarians. Instead, they have colloblasts (sticky cells) to capture the prey. Ctenophora is represented by very few members, hence it is considered as one of the minor phyla.



**Colloblast**



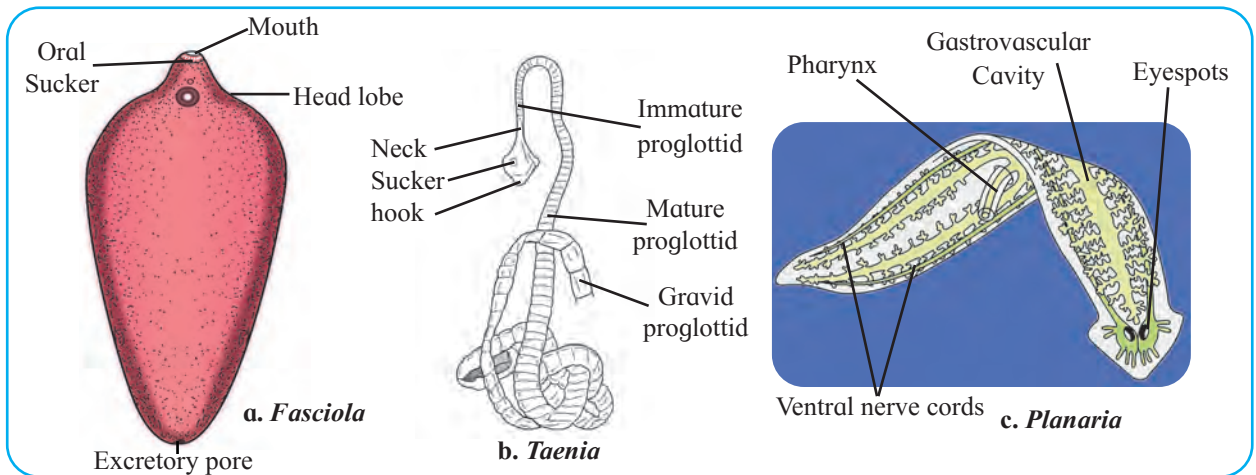
**Pleurobrachia**

**Fig. 4.8 Animal of Ctenophora**

**4. Phylum : Platyhelminthes (platy -flat, helminth -worms)**

e.g. *Planaria*, *Taenia* (Tapeworm), *Fasciola* (Liver fluke).

Body of these animals is dorso-ventrally flattened, hence are called as flat worms. Animals are acoelomate, triploblastic showing organ-system grade of organization. Mostly endoparasitic and few are free-living. Parasitic forms shows presence of hooks and suckers for attachment to the body of host. Body is covered by cuticle (in parasites) or cilia (in free-living forms). Digestive system is generally absent in parasitic forms, but in free-living forms, it is incomplete (blind-sac plan). Animals have flame cells or protonephridia, helpful for excretion and osmoregulation. Animals are hermaphrodite (bisexual). Self fertilization is seen. Few have high power of regeneration and show polyembryony.

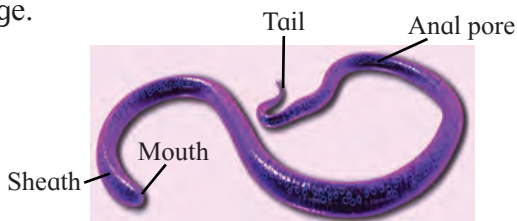


**Fig. 4.9 Animals of platyhelminthes**

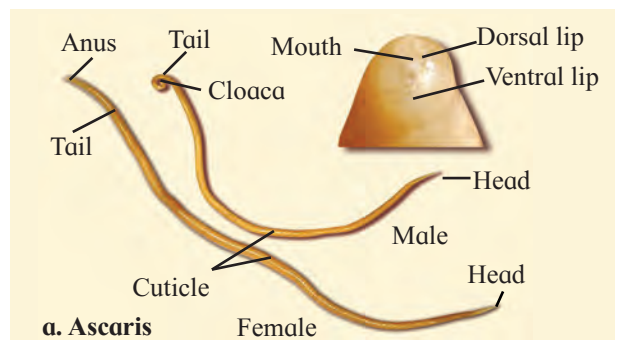
**5. Phylum : Aschelminthes (ascus-sac, helminth-worm) / Nemathelminthes (nema-thread)**

e.g. *Ascaris* (Roundworm), *Wuchereria* (filarial worm), *Ancylostoma* (hook worm).

These are mostly parasitic, few forms are free-living. Body is long, cylindrical, thread like, circular in cross-section, hence are called round worms. They are triploblastic, bilaterally symmetrical, pseudocoelmate, with tube within tube body plan. Body is covered by tough and resistant cuticle. Body wall has longitudinal muscles but no circular muscles. Alimentary canal is complete with mouth and anus at opposite ends. Pharynx is well developed and muscular. Excretion takes place by canals or gland cells. Excretory products are eliminated through excretory pore. Nervous system has nerve ring and nerves. Animals are unisexual i.e. sexes are separate. Animals like *Ascaris* shows sexual dimorphism. Usually female is longer and broader and have straight posterior end. Male is shorter and narrower and has curved posterior end with a pair of penial setae for copulation. Fertilization is internal. Development may or may not include larval stage.



**Fig. 4.10 Wuchereria**



**b. Ancylostoma hookworm**

**Fig. 4.11 Animals of Aschelminthes**



**Can you tell?**

1. State parasitic adaptations in liverfluke and *Ascaris*.
2. Give example of free living platyhelminth.

**6. Phylum : Annelida (Annulus : Ring)**

e.g. *Nereis*, *Pheretima* (Earthworm), *Hirudinaria* (Leech).

They are commonly called ring worms or segmented worms. Animals may be aquatic and few may be ectoparasitic or free living or burrowing in moist soil. They show bilateral symmetry with metameric segmentation.

A special region of the body called -clitellum is present. Locomotion is with the help of longitudinal and circular muscles. Locomotory structures like setae (earthworm), parapodia (*Nereis*) or suckers (leech) are present. Alimentary canal is complete. Exchange of gases takes place through body wall. Circulatory system is of closed type. Excretion and osmoregulation is carried out with the help of nephridia. Nervous system consists of nerve ring and ventral nerve cord. Nerve cord is ventral, solid and ganglionated. Mostly hermaphrodites and few are dioecious (*Nereis*).



a. *Nereis*



b. *Hirudo*



c. *Pheretima*

**Fig. 4.12 Animals of Annelida**



### Always Remember

All animals from Annelida onwards are triploblastic, coelmate with organ system level of organization.



### Find out

1. What are the merits and demerits of hermaphroditism?
2. Why are leeches used in Ayurveda?
3. What is the role of earthworms in agriculture? What is vermicompost?

## 7. Phylum : Arthropoda (Arthros : Joint, Podos : leg)

e.g. Cockroach, Butterfly, Scorpion, Millipede, Prawn.

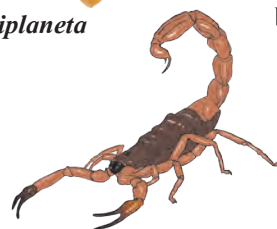
This is largest phylum of kingdom animalia. These animals have jointed appendages, hence the name -Arthropoda. These are omnipresent and solitary or colonial, most of them are free-living (Barnacles are sedentary). Few are parasitic and sanguivorous (female mosquito, bed bug). Their body is bilaterally symmetrical, triploblastic, eucoelomate, metamericly segmented with tube within tube body plan and organ-system level of organization. Body is covered by tough, non-living chitinous exoskeleton. Hence, they need periodic moulting (ecdysis). Body is divided into head, thorax and abdomen.



a. *Periplaneta*



b. *Archispirostreptus*



c. *Hottentotta*

**Fig. 4.13 Animals of Arthropoda**

Digestive system is complete. Circulatory system is of open type, blood flows through body cavity (haemocoel). Respiratory organs are gills, trachea, book lungs, book gills. Excretion takes by green glands, Malpighian tubules or coxal glands. Nervous system is formed by nerve ring and double, ventral, ganglionated nerve cord. Sense organs are well developed in the form of antennae, simple or compound eyes, various receptors. Sexes are separate showing sexual dimorphism, fertilization is generally internal, development is direct or indirect by metamorphosis. In some arthropods like honey bees, bugs etc. offsprings are produced by parthenogenesis. Some insects exhibit polymorphism e.g. honey bee, ants, termites etc. Some arthropods are economically important such as *Apis* (honey bees) for their honey and wax.

Lac is produced by *Laccifer lacca* (Lac insect). Lobsters, prawns and crabs are edible, silk worms produce silk. Some arthropods are harmful which acts as vector e.g. mosquito. *Locusta* (locust) is a gregarious pest. *Limulus* (King crab) is known as living fossil.



### Find out

1. Why is phylum arthropoda considered as most successful phylum?
2. What do we mean by parthenogenesis?
3. What do we mean by living fossil?
4. How the bees produce honey?
5. What will happen if arthropods do not moult?

### 8. Phylum : Mollusca (Mollis : soft)

e.g. *Pila*, Bivalve, *Octopus* (devil fish), *Sepia* (cuttle fish), *Chaetopleura* (Chiton), *Pinctada* (Pearl oyster), *Loligo* (Squid), *Aplysia* (Sea hare), *Dentalium* (Tusk shell).

This is second largest phylum. Molluscs are either free living or sedentary. They are aquatic or seen in marshy places. Few are terrestrial. These are soft bodied and show tube within tube body plan. These are bilaterally symmetrical, but few are asymmetrical due to torsion (twisting). Body is divisible into head, foot and visceral mass. Visceral mass is enclosed in thick muscular fold of body wall called mantle. Mantle secretes a hard calcareous shell, the shell may be external or internal or absent. Muscular foot is present on ventral side.

Digestive system is well developed, complete with anterior mouth and posterior anus. Buccal cavity has a rasping organ called radula which is provided with transverse rows of teeth. Aquatic forms show numerous feather like gills called ctenidia, useful for aquatic respiration. Gills are present in mantle cavity. (space between visceral mass and mantle) Terrestrial forms may show presence of lungs.

Circulatory system is of open type (except *Sepia*, which possesses closed type). Blood contains a copper containing blue respiratory pigment called haemocyanin. Excretion occurs by kidneys, also called as organ of Bojanus. Nervous system is formed by three pairs of ganglia. Ganglia are interconnected by commissures and connectives. Sense organs such as eyes for vision, tentacles for tactile sensation, osphradia for testing purity of water are present. Sexes are separate, animals are mostly oviparous, development is direct or indirect.

**Economic importance -** Pearl oyster gives precious pearls. Many molluscs are edible. Shells of molluscs are rich source of calcium.



### Can you tell?

1. Explain the term metameric segmentation.
2. Give characteristics of Arthropoda.
3. Enlist harmful Arthropods.
4. Why do Molluscs have shell?



a. *Spisula*



b. *Chaetopleura*



c. *Pila*



d. *Sepia*



e. *Octopus*

**Fig. 4.14 Animals of Mollusca**

**9. Phylum : Echinodermata**  
**(Echinus - Spines, derma - skin)**

e.g. *Asterias* (Sea star), *Cucumaria* (Sea cucumber), *Echinus* (Sea urchin), *Antedon* (sea lily), *Ophiothrix* (Brittle star).

These are exclusively marine, solitary, sedentary or free-living and gregarious, benthic.

These are radially symmetrical animals with pentamerous symmetry. Body may be spherical, elongated or star-shaped. Endoskeleton is made up of calcareous ossicles. Spines are present on the body, hence the name echinodermata. The body is without definite body divisions, instead, there are two sides as oral and aboral.

The peculiar character is presence of water vascular system in which water enters through madreporite. This system is used in locomotion, food capturing, respiration, etc. Digestive system is complete. Mouth is ventrally present on oral surface and anus on aboral surface.

Respiration is performed by peristomial gills, papillae, respiratory tree, etc. Circulatory system and excretory system is absent.



a. *Antedon*

b. *Ophiothrix*



c. *Asterias*

d. *Cucumaria*

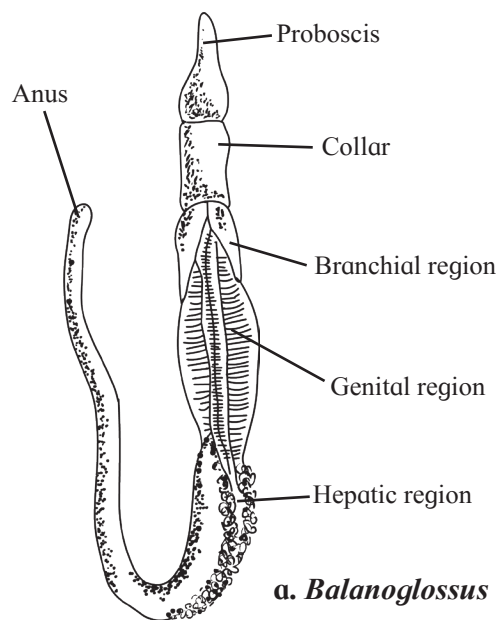
**Fig. 4.15 Animals of Echinodermata**

Nervous system is simple with a nerve ring around mouth and radial nerves in the arms. Sexes are separate (sometimes bisexual), fertilization is external, development is indirect. They show high power of regeneration.

**10. Phylum : Hemichordata (Hemi : Half, Chordata : Rod)**

e.g. *Balanoglossus*, *Saccoglossus*.

Earlier, this Phylum was considered as sub-phylum of Chordata because buccal diverticulum was considered as notochord. But, now it is placed as a separate phylum of Non-chordata. These are exclusively marine animals, usually living at the bottom of sea in burrows. Mostly these are free living but the animals like *Rhabdopleura* are sedentary. Body is soft, vermiform, unsegmented and divided into three parts - proboscis, collar and trunk. Buccal cavity gives rise to rod-like buccal diverticulum which is considered as notochord by some scientists.



a. *Balanoglossus*



b. *Saccoglossus*

**Fig. 4.16 Animals of Hemichordata**

Alimentary canal is complete, straight or 'U' shaped. Respiration occurs by numerous gills, arranged in two longitudinal rows, present in the pharyngeal region. Gills open by gill slits.

Circulatory system is simple and open type. Excretion occurs with the help of glomerulus. Nervous tissue is embedded in epidermis on both dorsal and ventral sides. The sexes are separate (sometimes bisexual). Fertilization is external and development is indirect through free swimming larva. This phylum is the connecting link between non-chordata and chordata.



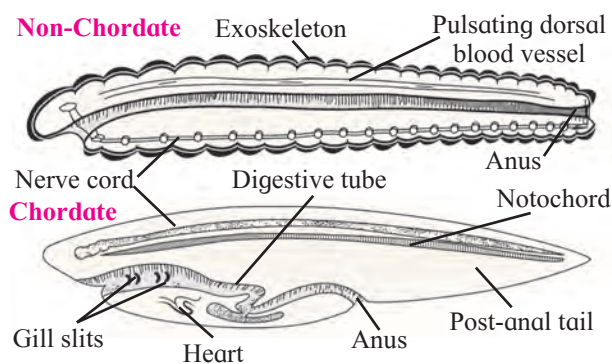
### Can you tell?

1. Give salient features of Phylum Echinodermata.
2. Hemichordata is the connecting link between non-chordata and chordata. Give reasons.



### Observe and Discuss

Compare and contrast between Chordates and Non-chordates.



### Find out

Why *Balanoglossus* is considered as connecting link between Non-Chordates and Chordates?



### Do you know ?

Notochord is flexible rod-like structure of vacuolated cells. It is located along the dorsal side of chordate embryos. It gives support to the body and provides attachment to muscles.

## 11. Phylum : Chordata

Chordates are characterised by presence of cartilagenous notochord at least in early embryonic life, presence of gill slits in the pharyngeal (neck) region, presence of hollow, dorsal nerve cord running through out the length of body and ventral heart.

Phylum Chordata is divided into three subphyla-Urochordata, Cephalochordata and Vertebrata. Urochordata and Cephalochordata are collectively called Protochordates.

### a. Subphylum : Urochordata or Tunicata

e.g. *Herdmania*, *Salpa*, *Doliolum*.

These are also called as tunicates or ascidians. They are exclusively marine. Body is soft and covered by 'test' or 'tunic' which is made up of tunicine. Notochord is present only in the tail of larva, hence the name, urochordata. Notochord is lost during metamorphosis. Pharynx has many gill slits. Closed circulatory system is present. Development is indirect.



a. *Herdmania*



b. *Ascidia*

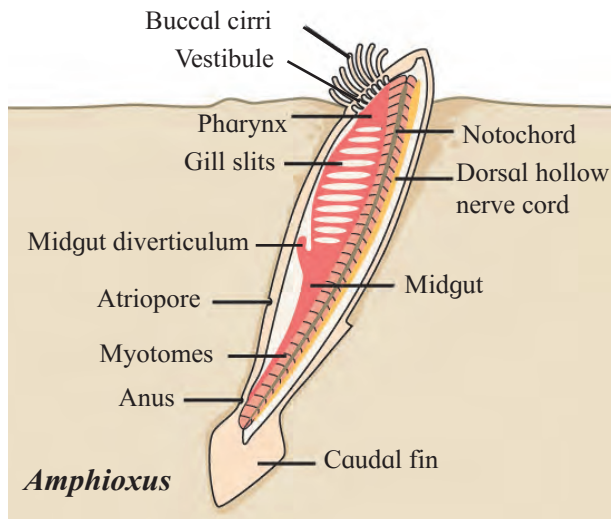
Fig. 4.17 Animals of Urochordata

### b. Subphylum : Cephalochordata

e.g. *Branchiostoma* (*Amphioxus* or *Lancelet*)

They are exclusively marine. These are also called as lancelet, which are small fish like animals that rarely exceed 5 cm in length.

Lancelets partly live burried in soft marine sediments. Notochord extends throughout the length of body and present throughout the life. Myotomes (muscle blocks) are present. Post-anal tail is present. Closed circulatory system is present. Blood is without pigment.



**Fig. 4.18 Animal from Cephalochordata**

### c. Subphylum : Vertebrata

In these chordates, notochord is replaced by cartilaginous or bony vertebral column. It is divided into two divisions - *Agnathostomata* (no jaws) and *Gnathostomata* (jaws present).

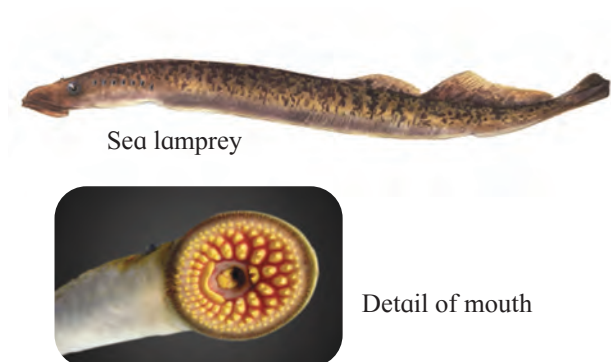
#### 1. Division : *Agnathostomata*

This division includes the lowest or most primitive vertebrates, which are without jaws. They include only one class of living vertebrates - the Cyclostomata.

Class : *Cyclostomata* (Cyclos : Circular, Stoma - mouth) Lat/Grk.

e.g. *Petromyzon* (Lamprey), *Myxine* (Hagfish).

*Cyclostomes* are jawless and eel-like animals. Skin is soft, smooth containing unicellular mucus glands, but no scales. Median fins are present but paired fins are absent. They are ectoparasites. They have sucking and circular mouth without jaws. Cranium and vertebral column made up of cartilage.



**Fig 4.19 *Petromyzon***

Digestive system lacks stomach. Respiration occurs by 6 to 15 pairs of gills slits. Gills slits are without operculum. Heart is two chambered with one auricle and one ventricle. Gonad is single, large and without gonoduct. Fertilization is external. They are anadromous i.e. migrate for spawning to fresh water from their marine habitat. After spawning, they die within few days. Larvae metamorphose and then migrate to ocean.



#### Can you tell?

1. *Herdmania* is called a Chordate. Explain.
2. Give characteristics of *Petromyzon*. Comment on its mode of nutrition.

#### 2. Division : *Gnathostomata*

It is divided into two superclasses - Pisces (bear fins) and tetrapoda (bear four limbs).

##### A. Superclass : *Pisces*

These are aquatic animals. These are poikilothermic (body temperature changes according to the change in surrounding temperature). Lateral line system is present which shows presence of rheoreceptores for detection of water current. Locomotion is by body muscles and fins. Caudal fin acts as steering wheel. Exoskeleton is of dermal scales. Endoskeleton is either bony or cartilagenous. Body is streamlined and boat shaped. This feature offers minimum resistance during swimming. Respiration is by gills. Heart is two chambered and is ventral in position. It shows single and closed circulation. Heart always shows presence of deoxygenated blood, so it is described as venous heart. They have well developed brain with large olfactory lobes. Sexes are separate. Most fishes are oviparous and some are viviparous.

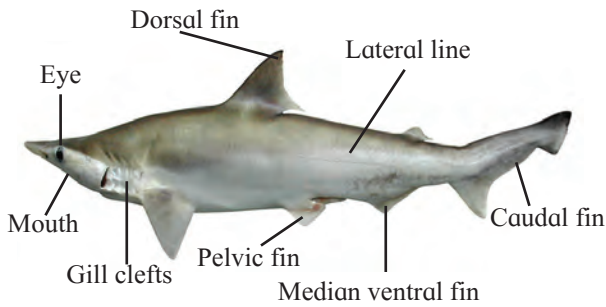
Superclass Pisces is divided into two classes as below.

#### 1. Class *Chondrichthyes* :

(chondron : cartilage, ichthyes : fish)

e.g. *Scoliodon* (Dog fish), *Pristis* (Sawfish), Electric ray, Common skate, Hammer headed shark.

*Carcanodon* (great white shark), *Trygon* (Sting ray)



a. *Scoliodon*



b. *Anoxypristis*

**Fig 4.20 Animals from chondrichthyes**

*Chondrichthyes* includes the animals in which endoskeleton is cartilagenous. These are exclusively marine. Exoskeleton is formed of placoid scales. Teeth are modified placoid scales which are backwardly directed. Mouth is ventral in position. 2 pairs of lateral fins (pectoral and Pelvic). Caudal fin is heterocercal (Asymmetrical). Five to seven pairs of gill slits are present. They are not covered by operculum. Air bladder is absent hence these fishes need to swim constantly so that they do not sink. They are predatory fishes. Some of them have electric organs e.g. *Torpedo* - (electric ray) and some have poison sting e.g. *Trygon* - (sting ray) as organs of offence and defence. Male copulatory organs called claspers are present. Fertilization is internal. Many of them are viviparous.

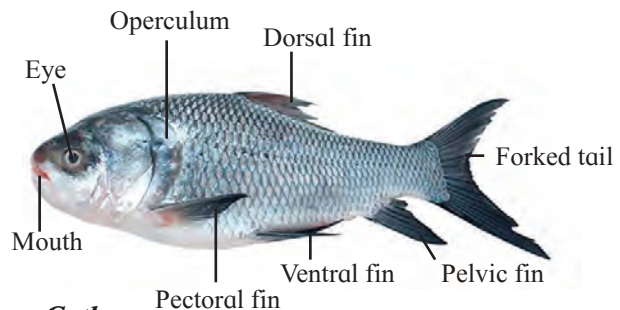
## 2. Class : Osteichthyes

(Osteon : bone , ichtyies : fish)

e.g. Bombay duck, Lung fishes (*Protopterus*, *Lepidosiren*)

*Exocoetus* (flying fish), *Hippocampus* (sea-horse), Pomphret, *Labeo rohita* (Rohu), *Catla* (Katla), *Clarias* (Magur), Aquarium fishes. *Betta* -(fighting fish), *Pterophyllum* (Angle fish).

Osteichthyes includes fishes in which bony endoskeleton is present, hence called as bony fishes. These are aquatic, present in both fresh and marine waters. Exoskeleton is formed of cycloid and ctenoid scales. Mouth is mostly terminal in position. Tail fin is formed by two equal lobes i.e. homocercal (symmetrical). Four pairs of gill slits are present, covered with operculum. Air bladder is present to maintain buoyancy. Claspers are absent. Fertilization is external. These fishes are oviparous.



a. *Catla*



b. *Exocoetus* (flying fish)



c. *Hippocampus* (sea-horse)

**Fig 4.21 Animals from Osteichthyes**



Can you tell?

1. Differentiate between Chondrichthyes and Osteichthyes on the basis of scales and caudal fin.
2. What is the lateral line system?
3. Why Piscian heart is called a venous heart?



## B. Superclass : *Tetrapoda*

These animals bear two pairs of appendages. Some animals like snakes are secondarily limbless.

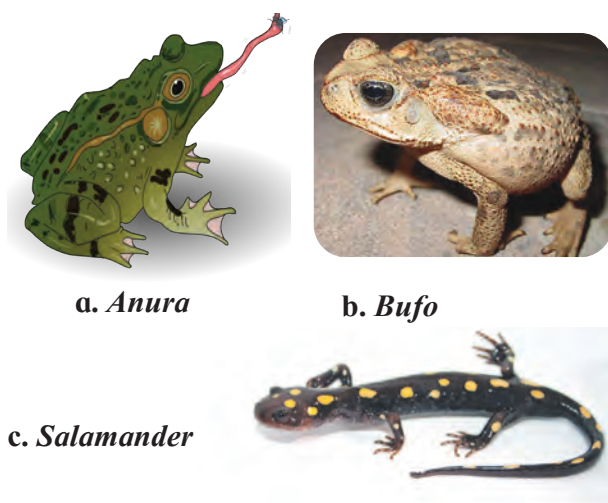
**Superclass tetrapoda includes four classes namely, Amphibia, Reptilia, and Mammalia.**

### 1. Class : Amphibia

(Amphi : both, bias : life)

e.g. *Rana* (Frog), *Bufo* (Toad), *Salamandra* (Salamander), *Ichthyophis* (Limbless amphibian), *Hyla* (Tree frog).

Amphibia include the animals which live on land as well as in water (fresh water only). They are poikilothermic animals. Body is differentiated into head and trunk. Neck and tail is usually absent in many adults with few exceptions. Two pairs of limbs arise from pectoral and pelvic girdles respectively. These help in locomotion. Skin is moist, glandular with mucous glands. Exoskeleton is absent. Eyelids are present. Tympanum represents the ear. Excretory products, digestive wastes and gametes are released through common chamber called cloaca. Circulatory system is of closed type. Heart is three chambered and ventral in position. RBCs are biconvex and nucleated. Respiration is by skin, lungs and buccopharynx. Nervous system is well developed. Sexes are separate. These are oviparous. Fertilization is external. Development is indirect through aquatic larval stage. They show metamorphosis.

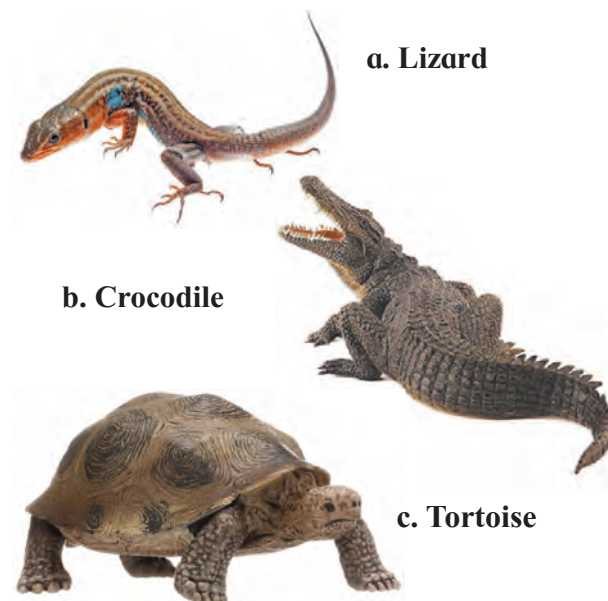


**Fig 4.22 Animals from Amphibia**

## 2. Class : Reptilia

(Repere : to creep or to crawl)

e.g. *Naja naja* (Cobra), *Hemidactylus* (Wall lizard), *Chelonia* (Turtle), *Crocodylus* (Crocodile), *Testudo* (Tortoise), *Chameleon* (Tree lizard), *Bangarus* (Krait), *Vipera* (viper).



**Fig 4.23 Animals from Reptilia**

Reptilia includes crawling animals. These are the first true terrestrial vertebrates. Few may be aquatic or semi-aquatic, also found in marshy area. Locomotion occurs by limbs. The limbs are pentadactyl and digits bear claws. Limbs help the animal to walk or creep. Snakes are limbless. Snakes crawl on their belly. Reptiles are poikilotherms. Skin is dry, non-glandular and covered by exoskeleton of epidermal scales or scutes, shields or plates. Lizards and snakes shed their skin periodically. Tympanum is present. Heart has two complete auricles, but ventricles are incompletely partitioned. So heart is not perfectly four chambered (except crocodile). Brain is well developed. The olfactory lobes and cerebellum are better developed than those of amphibians. Sexes are separate and show prominent sexual dimorphism. Fertilization is internal. They are oviparous (except viper, it is viviparous) and show parental care. .



### Can you tell?

1. Amphibians do not have exoskeleton. Give reason.
2. Why are amphibians and reptilians called poikilotherms?

### 3. Class : Aves (Avis : bird)

e.g. *Columba* (Pigeon), *Psittacula* (Parrot), Flight less birds like *Struthio* (ostrich), *Kiwi*, *Aptenodytes* (Penguin), *Corvus* (crow), *Neophron* (Vulture), *Passer* (sparrow).

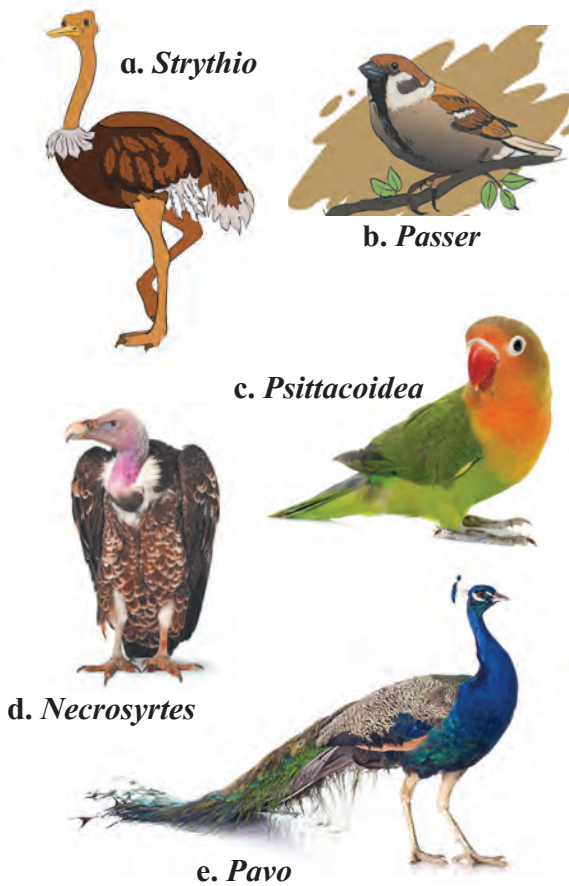


Fig 4.24 Aves

Forelimbs are modified into wings for flying (some birds have lost the capacity to fly e.g. Ostrich), hind limbs are used for walking, clasp tree branches and running. Aquatic birds have webs between their toes (e.g. Duck). Body is streamlined (Boat shaped) to reduce resistance during flight. These are homeotherms i.e. their body temperature remains constant. Exoskeleton is made up of feathers. Scales are present on hind limbs.

Body is differentiated into head, neck, trunk and tail. Skin is thin, dry, non-glandular except oil gland at the base of tail (uropygial gland). Bones are hollow (pneumatic) with air cavities to reduce body weight. Jaws are without teeth and modified into beak. Crop and gizzard are present in digestive system. Blood is red in colour due to presence of red blood cells. RBCs are biconvex and nucleated. Heart is perfectly four chambered. They show double circulation. Respiration takes place by lungs, having air sacs to increase the buoyancy. Brain is enlarged and has well developed cerebellum for equilibrium. Sexes are separate with prominent sexual dimorphism. These are oviparous. Fertilization is internal. Parental care is very well developed. Seasonal migration is seen in some birds.

**Special features :-** The urinary bladder is absent. The female shows presence of only left ovary and left oviduct. This helps to reduce body weight.

### 4. Class : Mammalia (mammar : breasts, nipples)

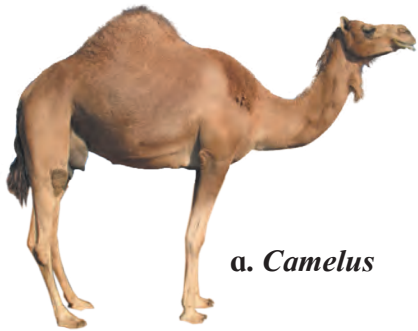
e.g. Bat, *Rattus* (Rat), *Macaca* (Monkey), *Camelus* (Camel), Whale, Human being, *Cannis* (dog), *Felis* (Cat), *Elephas* (Elephant), *Equus* (Horse), *Pteropus* (flying fox).  
Oviparous - *Ornithorhynchus* (Platypus).  
Viviparous - *Macropus* (Kangaroo).

Mammalia includes the animals having mammary glands (milk producing glands) for the nourishment of young ones. These are omnipresent. Mostly terrestrial, some are aquatic and few are aerial and arboreal. Limbs are the organs of locomotion and used for walking, flying, climbing, burrowing, swimming, etc. Body is differentiated into head, neck, trunk and tail. These are homeotherms. Exoskeleton is in the form of hair, fur, nails, hooves, horns, etc. Skin is glandular having sweat glands and sebaceous glands (oil glands). Mammary glands are modified sweat glands.

They have external ear (pinna). They show heterodont dentition. RBCs are biconcave and enucleated. Blood is red in colour. Heart is ventral in position and four chambered. Respiration takes place by lungs. Brain is highly developed. Cerebrum shows a transverse band called corpus callosum. Few mammals are oviparous (e.g. Duck billed platypus). Some have pouches for the development of immature young ones, these are called marsupials e.g. Kangaroo. Majority of mammals are placental and viviparous.



d. *Macropus*



a. *Camelus*



b. *Ornithorhynchus*



c. *Trachypithecus*

**Fig 4.25 Mammals**



**Can you tell?**

1. Give adaptations in aves for flying.
2. Aves and mammals are homeotherms. Give reason.
3. How mammals differ from other groups of animals.

**Do yourself**

Observe different animals in your surrounding, write detailed classification and write down the characteristics of animals in following format.

Picture / Photograph	Classification	Characteristics



## Exercise

### 1. Choose correct option

- A. Which of the following belongs to a minor phylum?  
a. Comb jelly    b. Jelly fish  
c. *Herdmania*    d. *Salpa*
- B. Select the animal having venous heart.  
a. Crocodile                      b. Salamander  
c. Rohu                              d. Toad
- C. In *Ascaris*, \_\_\_\_\_.  
a. mesoglea is present  
b. endoderm is a discontinuous layer  
c. mesoderm is present in patches  
d. body cavity is absent
- D. Which of the following is incorrect in case of birds?  
a. Presence of teeth  
b. Presence of scales  
c. Nucleated RBCs  
d. Hollow bones
- E. Chitinous exoskeleton is a characteristic of \_\_\_\_\_.  
a. *Dentalium*                      b. *Antedon*  
c. Millipede                        d. Sea urchin

### 2. Answer the following questions

- A. Reptiles are known for having three chambered heart. Which animal shows a near four chambered condition in reptiles?
- B. The circulatory system has evolved from open to closed type in Animal kingdom. Which Phylum can be called first to represents closed circulation?
- C. Pinna is part of external ear and it is found in mammals. Do aves and reptiles show external ear in any form?
- D. Fish and frog can respire in water. Can they respire through their skin? If yes, why do they have gills?

- E. Birds need to keep their body light to help in flying. Hence, they show presence of some organs only on one side. How their skeleton helps in reducing their weight?
- F. Cnidarians and Ctenophorans are both diploblastic. Which other character do they have in common, which is not found in other Phyla?
- G. Crab and Snail both have a protective covering. Is it made up of the same material?
- H. Sponge and sea star show calcareous protective material. Do they belong to the same Phylum?
- I. Fish and snake both have scales. How do these scales differ from each other?
- J. Lower Phyla like Arthropods and Cnidarians show metamorphosis. Is it also found in any class of Phylum Chordata?

### 3. Draw neat labelled diagram

- A. *Sycon*  
B. *Aurelia*  
C. *Amphioxus*  
D. *Catla*  
E. *Balanoglossus*  
F. *Scolidon*

### 4. Match the following

Phylum	Characters
i. Annelida	a. Tube feet
ii. Mollusca	b. Ostia
iii. Ctenophora	c. Radula
iv. Porifera	d. Parapodia
v. Echinodermata	e. Comb plates

5. Identify the animals given in pictures and write features of its phylum / class



A



B



C



D



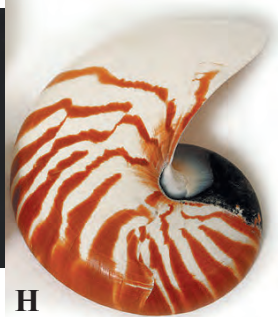
E



F



G

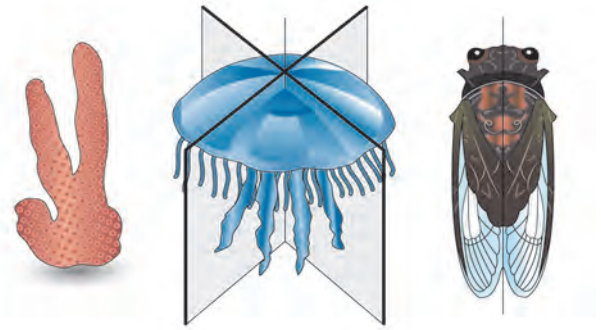


H



I

6. Observe and identify body symmetry of given animals



**Practical / Project :**

Study different animals in kingdom animalia and prepare the chart with detail scientific information.

## 5. Cell Structure And Organization



### Can you recall?

1. Who observed cells under the microscope for the first time?
2. Who made the first microscope?
3. How do onion peel cells and our body cells differ?
4. Why bacterial nucleus is said to be primitive?

### 5.1 Cell :

Cell is called a structural and functional unit of life of all living organisms capable of independent existence and can perform all functions of life.

To see cells clearly we need a microscope. Larger cells can be seen through simple microscope but to see smaller cells we require compound microscope. Simple microscope can magnify image 50 to 100 times but a compound microscope can do so 1000 times or more. In the microscope we use in the laboratory, a beam of light is used to make things visible hence it is light microscope. To see interior of cell we need electron microscope. It can magnify image 500000 times.



Leeuwenhoek  
Microscope  
(late 1600s)

Fig. 5.1 Microscope

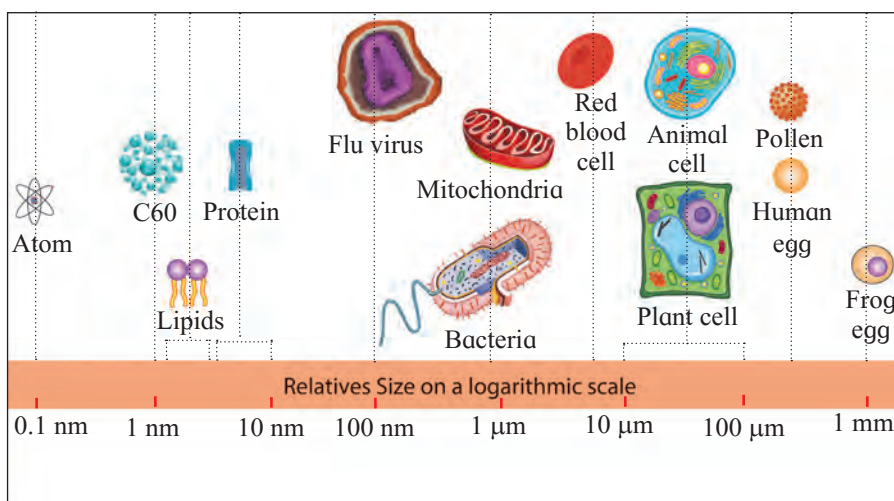


Fig. 5.2 Cell size

There is no typical shape of a cell. Cells may be spherical, rectangular, flattened, polygonal, oval, triangular, conical, columnar, etc.

Cell size varies greatly in various plants and animals. Some of them are not visible to naked eye. Some are barely visible while some are macroscopic. The smallest cell size can be seen in mycoplasma (0.3 μm in length), bacterial cell size is 3 to 5 μm, while the largest size of cell is seen in Ostrich egg (nearly 15cms). Longest cells are nerve cells.

You already know that cell theory was proposed by Schwann and Schleiden. However, in this theory, there was no explanation about formation of new cells. It was Rudolf Virchow (1855) who explained for the first time that new cells are formed by cell division from pre existing cells (*Omnis cellula-e-cellulla*).

In later years, advanced research in cytology led to modification in cell theory, which is now known as Modern Cell Theory.



### Find out

1. How does a combination of lenses help in higher magnification?
2. When do we use plane and concave mirror and diaphragm?
3. What is the difference between magnification and resolution?

**Totipotency :** It is the capacity or the potential of living nucleated cell to differentiate and divide to form any other type of cell and thereby a complete new organism.

A cell is totipotent because it has the entire genetic information of the organism in its nucleus. Embryonic animal cells are totipotent and termed as **stem cells**. Stem cells have great medical applications including cure for diseases.



### Know the scientists

A German botanist Matthias Schleiden (1838) examined number of plants and concluded that various tissues of plants are composed of different types cells. At that time, a British zoologist Theodore Schwann (1839) proposed that cells are bound by a thin membrane. He also explained about existence of cell wall as a unique character of plant cell. On the basis of his observation, he proposed that animals and plants are made up of cells and products of cells.

### Postulates of modern cell theory,

- All living organisms are made up of cells.
- Living cells arise from pre-existing cells.
- A cell is the structural and functional unit of life.
- Total activities of cells are responsible for activity of an organism.
- Cells show transformation of energy.
- Cells contain nucleic acids; DNA and RNA in the nucleus and cytoplasm.

## 5.2 Kinds of cells :

Living organisms are grouped into two main categories the Prokaryotes and Eukaryotes. The prokaryotes have simple cellular organization while eukaryotes exhibit high degree of organization.

### A. Prokaryotic cells :

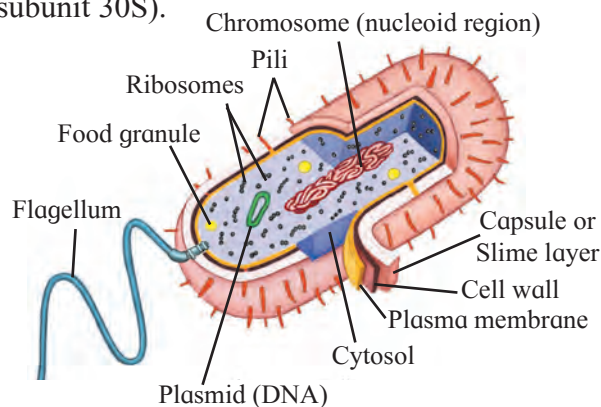
The cell in prokaryotes show following main features. It has chemically complex protective cell envelope. However, it does not have well-defined nucleus and other membrane bound cell organelles.

Cell envelope is a three-layered structure with outer glycocalyx, middle cell wall and inner plasma membrane. Glycocalyx is present as either slime layer (loose sheath) or capsule (tough). Bacteria are better observed when stained.

The most followed staining method is ‘Gram staining’ developed by Danish bacteriologist Hans Christian Gram. The cell wall is made up of peptidoglycan (in Gram positive bacteria) and murein (in Gram negative bacteria). It gives mechanical strength to the cell. Cell membrane is a phospholipid bilayer. All these structures give protection to the cell and also help in inter-cellular transport. In motile bacteria, either cilia or flagella are found. Both are driven by rotatory movement produced by basal body (which works as motor). Other parts are filament and hook.

Some other surface projections are the tubular pili (which help in inter-cellular communication) and fimbriae (for clinging to support).

The cell membrane shows infoldings called mesosomes, which help in cell wall formation, cellular respiration and DNA replication. Some bacteria especially photosynthetic cyanobacteria show more longer extensions called chromatophores. They carry photosynthetic pigments. The cytoplasm contains dense particles called ribosomes helping in protein synthesis. Ribosomes are described by their sedimentation rate in Svedberg units. Bacterial ribosome are 70S (composed of a larger subunit 50S + smaller subunit 30S).



**Fig. 5.3 Prokaryotic cell**



### Find out

Why do basal body of bacterial flagella considered as smallest motor in the world?



### Do you know ?

- The term cell was first used by Robert Hooke (1665) in his book “Micrographic”.
- Purkinje and Mohl (1835-37) discovered protoplasm.
- Camillo Golgi (1838) discovered the Golgi apparatus.
- Robert Brown (1881) discovered the Nucleus.
- Balbiani (1881) discovered chromosomes in salivary glands of Chironomus larva.
- Flemming (1882) studied cell division in detail and coined the term Mitosis.
- Porter (1945) discovered Endoplasmic Reticulum.
- C. Benda gave the name Mitochondria.
- C. de Duve (1955) discovered Lysosomes.



### Always Remember

Genetic material in bacterium is a single chromosome made up of circular and coiled DNA ring. It remains attached to mesosome. This DNA undergoes a very typical replication pattern called as theta model of replication. The DNA is not associated with histone proteins (as in eukaryotes) hence not referred to as chromatin. Besides chromosomal DNA many bacteria show plasmids which are small circular DNA molecules carrying few genes. They are termed as extrachromosomal self-replicating DNA molecules. They are of two basic types F – plasmid for reproduction and R – plasmid for resistance against antibiotics. Cytoplasm of prokaryotes is a pool of all necessary materials like water, enzymes, elements, amino acids, etc. Some inclusion bodies in form of organic (cyanophycean starch and glycogen) and inorganic granules (phosphate and sulphur) are also found.



### Use your brain power

Describe major differences between prokaryotic and eukaryotic cells.

### B. Eukaryotic Cells :

Cells in which the nucleus has a definite nuclear membrane are known as Eukaryotic cells. These cells exhibit presence of membrane bound cell organelles. e.g. Cells of Protists, Plants, Animals and Fungi.

The eukaryotic cells though have different shapes, size and physiology but all the cells are typically composed of plasma membrane, cytoplasm and its organelles viz. Mitochondria, Endoplasmic Reticulum, Ribosomes, Golgi complex, etc. and a true nucleus.

### 5.3 Components of Eukaryotic cell :

**1. Cell wall:** It is rigid, supportive and protective outer covering of plasma membrane of plant cells, fungi and some protists. Algae show presence of cellulose, galactans, mannans and minerals like calcium carbonate in cell wall. In other plants, it is made up of hemicelluloses, pectin, lipids and protein. Microfibrils of plant cell wall show presence of cellulose which is responsible for rigidity. Some of the depositions of cell wall are silica (grass stem), cutin (epidermal walls of land plants), suberin (endodermal cells of root), wax, lignin. It gives shape to the cell and protects from mechanical injury and infections.

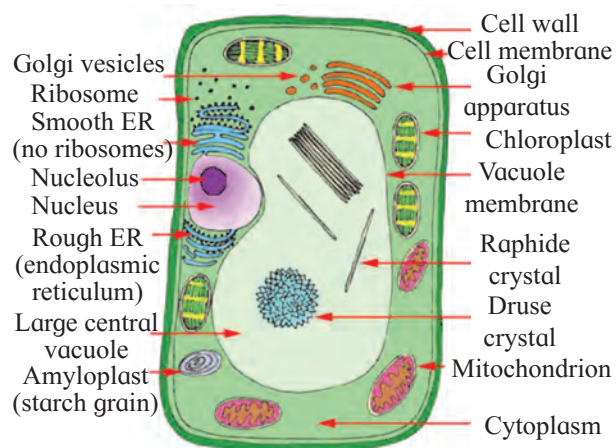
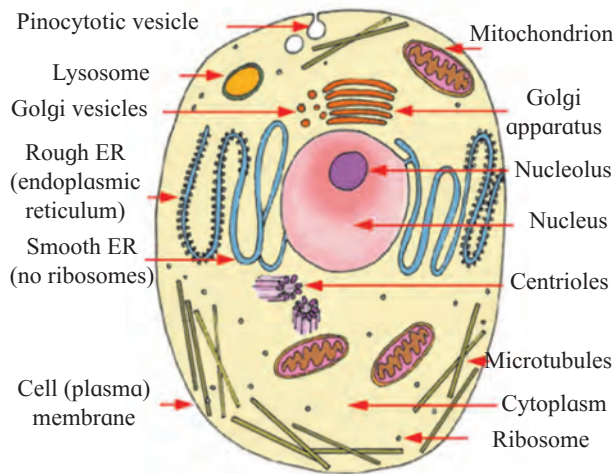


Fig. 5.4 Plant cell





**Fig. 5.5 Animal cell**

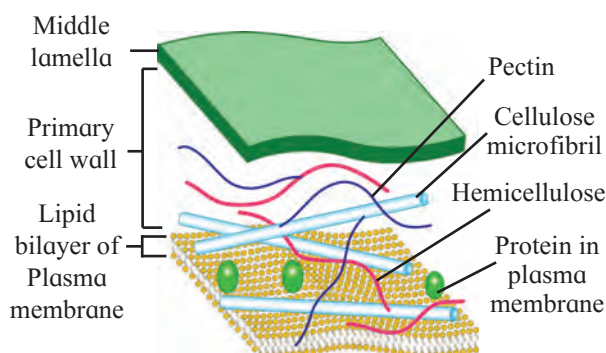
In plants, cell wall shows middle lamella, primary wall and secondary wall.

**Middle lamella :** It is thin and lies between two adjacent cells. It is the first structure formed from cell plate during cytokinesis. It is mainly made up of pectin, calcium and magnesium pectate. Softening of ripe fruit is due to solubilization of pectin.

**Primary wall :** In young plant cell, it is capable of growth. It is laid inner to middle lamella. It is the only wall seen in cells of meristematic tissue, mesophyll, pith, etc.

**Secondary wall :** It is present inner to primary wall. Once the growth of primary wall stops, secondary wall is laid. At some places thickening is absent which leads to formation of pits.

Plasmodesmata are cytoplasmic bridges between neighbouring cells which communicate through pores between primary cell wall and middle lamella.



**Fig. 5.6 Cell wall of plant cell**

## 2. Cell membrane / Plasma membrane/ biomembrane :

It is thin, quasifluid structure present both extracellularly and intracellularly. Extracellularly, it is present around protoplast and intracellularly, it is present around most of the cell organelles in eukaryotic cell. It separates cell organelles from cytosol.

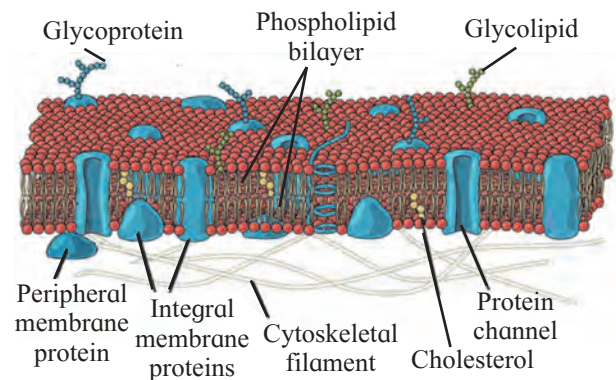
Thickness of biomembrane is about 75 Å. Under electron microscope, cell membrane appears trilamellate (made up of three layers). It shows presence of lipids (mostly phospholipids) arranged in bilayer. Lipids possess one hydrophilic polar head and two hydrophobic non-polar tails. So, phospholipids are amphipathic. Lipid molecules are arranged in two layers (bilayer) in such a way that their tails are sandwiched in between heads. Due to this, tails never come in direct contact with aqueous surrounding.

Cell membrane also shows presence of proteins and carbohydrates. Ratio of proteins and lipids varies in different cells. For example in human beings, RBCs show approximately 52% protein and 40% lipids.

### Fluid mosaic model :

It is most accepted model of cell membrane. It was proposed by Singer and Nicholson in 1972.

According to this model, it is made up of phospholipid bilayer and proteins. Proteins are like icebergs in the sea of lipids. Proteins can change their position. Some proteins are intrinsic i.e. occur at different depths of bilayer.



**Fig. 5.7 Fluid mosaic model**

They span the entire thickness of the membrane. So, they are called transmembrane proteins. They form channels for passage of water. Extrinsic or peripheral proteins are found on two surfaces of the membrane.

Quasifluid nature of lipid enables lateral movement of proteins. This ability to move within the membrane is measured as fluidity.

Main function of plasma membrane is transport of molecules across it. This membrane is selectively permeable. During passive transport, many molecules move across the membrane without spending energy. Some solutes move by simple diffusion along the concentration gradient (from higher to lower concentration). Neutral solutes may move across the membrane by the process of simple diffusion. This is called the passive transport. Water may also move by osmosis.

During active transport, few ions or molecules are transported against concentration gradient (from lower to higher concentration). It requires energy. So, ATP is utilized. As such a transport is an energy dependent process in which ATP is utilized, it is called Active transport e.g.  $\text{Na}^+/\text{K}^+$  pump. Polar molecules cannot pass through non-polar lipid bilayer. So, they require carrier proteins.

### 3. Cytoplasm :

The cell contains ground substance called **cytoplasmic matrix** or **cytosol**. This colloidal jelly like material is not static. It shows streaming movements called cyclosis. The cytoplasm contains water as major component along with organic and inorganic molecules like sugars, amino acids, vitamins, enzymes, nucleotides, minerals and waste products.

It also contains various cell organelles like endoplasmic reticulum, Golgi complex, mitochondria, plastids, nucleus, microbodies and cytoskeletal elements like microtubules. Cytoplasm acts as a source of raw materials as well as seat for various metabolic activities taking place in the cell.

It helps in distribution and exchange of materials between various cell organelles.

Cell organelles are nothing but compartments in the cell that carry out specific functions. Some of them coordinate with each other and complete specific tasks for the cell. Nuclear membrane, endoplasmic reticulum, Golgi complex, lysosomes and various types of vesicles and vacuoles form such a group and are together considered as **endomembrane system** of the cell. Organelles having distinct functions are not included in endomembrane system. e.g. mitochondria or chloroplast carry out specific type of energy conversions in the cell.

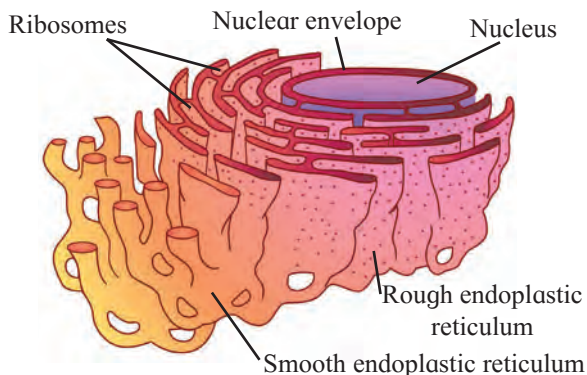
### 4. Endoplasmic Reticulum (ER):

This little network within the cytosol is present in all eukaryotic cells except ova and mature red blood corpuscles. Under the electron microscope, it appears like network of membranous tubules and sacs called cisternae. It forms more than 50% of the total membrane of a eukaryotic cell. This divides the cytoplasm in two parts viz; one within the lumen of ER called, laminal cytoplasm and non-laminal cytoplasm that lies outside ER.

Membrane of Endoplasmic reticulum is continuous with nuclear envelope at one end and extends till cell membrane.

It thus acts as intracellular supporting framework and helps in maintaining position of various cell organelles in the cytoplasm. The outer surface of endoplasmic reticular membrane may or may not be studded with ribosomes. Accordingly, it is called rough or smooth ER respectively. Smooth and rough ER differ in their functions.

Smooth ER is involved in various processes in different cells. Depending on cell type, it helps in synthesis of lipids (ex. steroid secreting cells of cortical region of adrenal gland, testes and ovaries), detoxification of drugs and poisons (liver cells) and storage of calcium ions (muscle cells).



**Fig. 5.8 Endoplasmic reticulum**

Rough ER is primarily involved in protein synthesis. (e.g. pancreatic cells that secrete insulin). These proteins are secreted by ribosomes attached to rough ER and are called secretory proteins. These proteins get wrapped in membrane that buds off from transitional region of ER. Such membrane bound proteins depart from ER as transport vesicles. Rough ER is also involved in formation of membrane for the cell. The ER membrane grows in place by addition of membrane proteins and phospholipids to its own membrane. Portions of this expanded membrane are transferred to other components of endomembrane system.

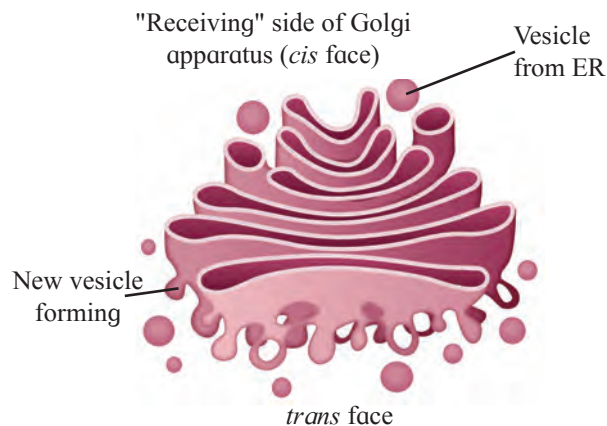
### 5. Golgi complex :

Golgi complex or Golgi apparatus or Golgi body; various terms are used to denote this assembly, manufacturing cum packaging and transport unit of cell.

Golgi complex essentially consists of stacks of hollow membranous sacs called cisternae. Diameter of cisternae varies from 0.5 to 1  $\mu\text{m}$ . A cell may have few to several cisternae depending on its function.

The thickness and molecular composition of two membranes of a Golgi sac differ from each other. The Golgi sacs show specific orientation in the cell. Each cisterna has a forming or 'cis' face (*cis*: on the same side) and maturing or 'trans' face (*trans*: the opposite side).

Transport vesicles that pinch off from transitional ER merge with *cis* face of Golgi cisterna and add its contents into the lumen.



**Fig. 5.9 Golgi complex**

This explains why Golgi bodies are usually located near ER. Modified and condensed secretions leave Golgi through *trans* face again as membrane bound vesicles.

Golgi body carries out two types of functions, modification of secretions of ER and production of its own secretions. Cisternae contain specific enzymes for specific functions. Refining of product takes place in an orderly manner. For example, glycolipids and glycoproteins that are brought from ER lose certain sugars and regain other, thus forming a variety of products.

Golgi bodies also manufacture their own products. Golgi bodies in many plant cells produce non-cellulose polysaccharides like pectin. Manufactured or modified, all products of Golgi complex leave cisternae from *trans* face as transport vesicles.



#### Always Remember

The cisternae in Golgi body are not physically connected to each other as that are in ER.

According to recent studies it is proposed that cisternae of Golgi body themselves mature moving from *cis* to *trans* face. It is called 'Cisternal maturation model'. It is also said that some vesicles recycle their enzymes that have been carried forward by moving cisternae back to less mature region.

While they are leaving from the Golgi, certain markers may get impregnated on their membrane so that they can identify their specific target cell or cell organelle.

## 6. Lysosomes :

Lysosomes can be considered as dismantling and restructuring units of a cell. These are membrane bound vesicles containing hydrolytic enzymes. The enzymes in lysosomes are used by most eukaryotic cells to digest (hydrolyse) macromolecules. The lysosomal enzymes show optimal activity in acidic pH. Lysosomes arise from Golgi associated endoplasmic reticulum.

The list of lysosomal enzymes includes all types of hydrolases viz, amylases, proteases and lipases. These enzymes are in inactive state and are activated only when a lysosome comes in contact with another particular organelle to form a hybrid structure.

After the action of enzymes is over, the lysosome is reformed and re-used. Lysosomes are thus found in various structural forms and carry out various functions for the cell.

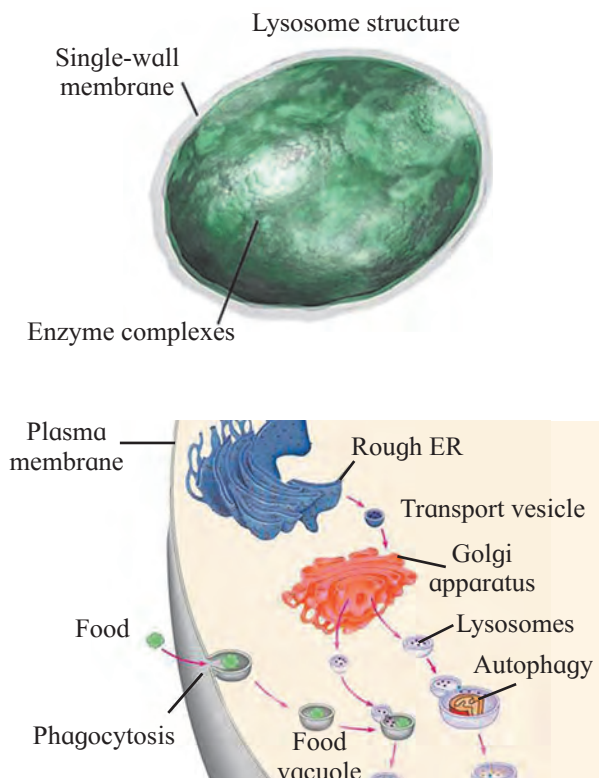
Lysosomes are polymorphic in nature. We can classify lysosomes as, Primary lysosomes; which are nothing but membrane bound vesicles in which enzymes are in inactive state.

Secondary lysosomes or hybrid lysosomes, which are formed by fusion of lysosome with endocytic vesicle containing materials to be digested, represented as heterophagic vesicle. This is larger in size than primary lysosome.

Residual body is the vesicle containing undigested remains left over in the heterophagic vesicle after releasing the products of digestion in the cytosol.

Lysosomes which bring about digestion of cells own organic material like a damaged cell organelle, are called autophagic vesicles (or suicide bags). An autophagic vesicle essentially consists of lysosome fused with membrane bound old cell organelle or organic molecules to be recycled. Remember, every week, a human liver cell recycles half of its macromolecules.

Lysosomes bring about intracellular and extracellular digestion. The intracellular digestion is brought about by autophagic vesicle or secondary lysosomes which contain foreign materials brought in by processes like phagocytosis. e.g. Food vacuole in amoeba or macrophages in human blood that engulf and destroy harmful microbes that enter the body.



**Fig. 5.10 Lysosomes**



### Always Remember

Lysosomal enzymes do not digest their own membrane proteins. Three-dimensional shape of these proteins probably protects the membrane.

Accidental release of lysosomal enzymes in limited amount does not harm the cell because pH of cytosol is near neutral.

Any insufficiency in secretion of lysosomal enzymes leads to disorders e.g. in genetic disorder, Tay Sachs's disease, due to insufficiency of lipase, brain gets impaired due to accumulation of fats.

Extracellular digestion is brought about by release of lysosomal enzymes outside the cell. e.g. acrosome, a cap like structure in human sperm is a modified lysosome which contain various enzymes like Hyaluronidase.

These enzymes bring about fertilization by dissolving protective layers of ovum.

During metamorphosis process found in many organisms, lysosomal enzymes help in reusing the tissues of redundant organs. They also help in destruction of malignant cells. e.g. T-lymphocytes.

### 7. Vacuoles :

Vacuoles are membrane bound sacs prominently found in plant cells. In animal cells, whenever present they are few in number and smaller in size. Generally, there are two or three permanent vacuoles in a plant cell.

In some large plant cells, a single large vacuole occupies the central part of the cell. It is called central vacuole. In such cells vacuole can occupy as much as 90% of the total volume of the cell.

The vacuoles are bound by semipermeable membrane, called tonoplast membrane. This membrane helps in maintaining the composition of vacuolar fluid, the cell sap, different from that of the cytosol. Composition of cell sap differs in different types of cells. The cell sap of central vacuole is a store house of various ions and thus is hypertonic to cytosol. Small vacuoles in seeds of certain plants store organic materials like proteins. In vacuoles along with excretory products other compounds are stored that are harmful or unpalatable to herbivores, thereby protecting the plants. Attractive colours of the petals are due to storage of such pigments in vacuoles.

Intake of food or foreign particle by phagocytosis involves formation of food vacuole. In fresh water unicellular forms like *Paramecium*, excretion and osmoregulation takes place through contractile vacuoles. Vacuoles maintain turgidity of the cell.

**In addition to endomembrane system, there are several other cell organelles bound by single layer of plasma membrane in the cell.**

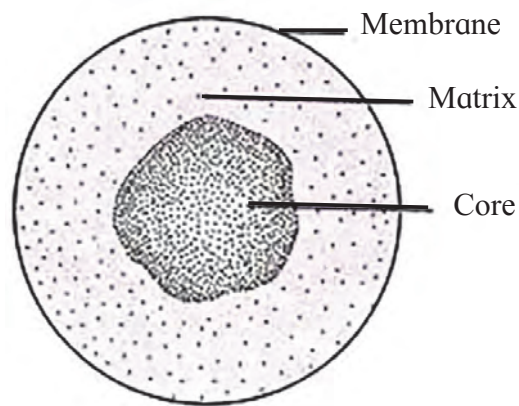
**Microbodies :** Microbodies are found in both plant and animal cells. These are minute membrane bound sacs. Microbodies contain various types of enzymes based on which they are classified into different types; few of which are explained here :

**Sphaerosomes :** These are found mainly in cells involved in synthesis and storage of fats. e. g. endosperm of oil seeds. The membrane of sphaerosome is half unit membrane i.e. this membrane has only one phospholipid layer.

**Peroxisomes :** Peroxisomes contain enzymes that remove hydrogen atoms from substrate and produce toxic hydrogen peroxide by utilisation of oxygen. At the same time peroxisome also contains enzymes that convert toxic  $H_2O_2$  to water. Conversion of toxic substances like alcohol takes place in liver cells by peroxisomes.

### 8. Glyoxysomes :

These membrane bound organelles contain enzymes that convert fatty acids to sugar. They can be observed in cells of germinating seeds where the cells utilise stored fats as source of sugar by reverse glycolysis till it starts photosynthesising on its own.



**Fig. 5.11 Glyoxysomes**

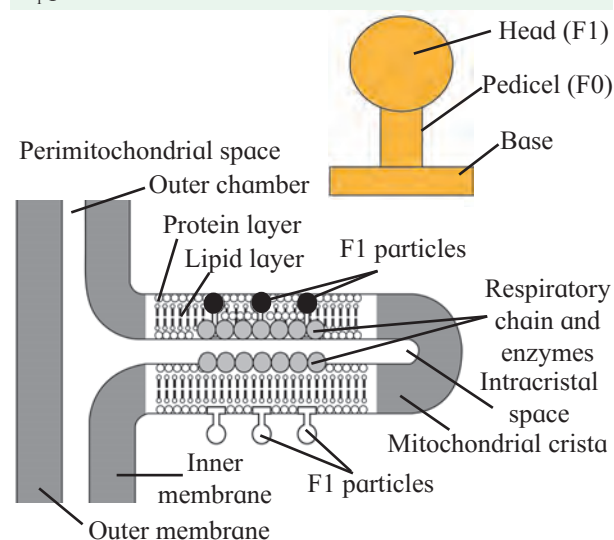
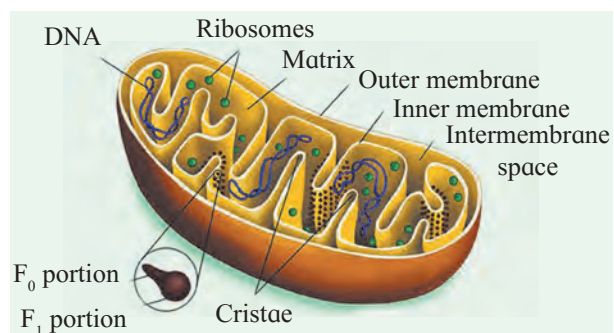
## 9. Mitochondria (Singular : Mitochondrion) :

These are important cell organelles involved in aerobic respiration. Mitochondria are absent in prokaryotic cells and red blood corpuscles (RBCs). Their shape may be oval or spherical or spiral strip like.

It is a double membrane bound organelle. Outer membrane is permeable to various metabolites due to presence of a protein -Porin or Parson's particles. Inner membrane is selectively permeable to few substances only. Both membranes are separated by a space- **outer chamber**.

Inner membrane shows several finger like or plate like folds- cristae. Inner membrane bears numerous particles- oxysomes and cytochromes / electron carriers.

Inner membrane encloses a cavity- inner chamber, containing a fluid- matrix. Matrix contains few coils of circular DNA, RNA, 70S types of ribosomes, lipids and various enzymes of Krebs cycle and other pathways.



**Fig. 5.12 Mitochondrion**



### Use your brain power

1. Why do we call mitochondria as power house of cell? Explain in detail. Hint: Refer chapter Cellular Respiration.
2. Are mitochondria present in all eukaryotic cells?

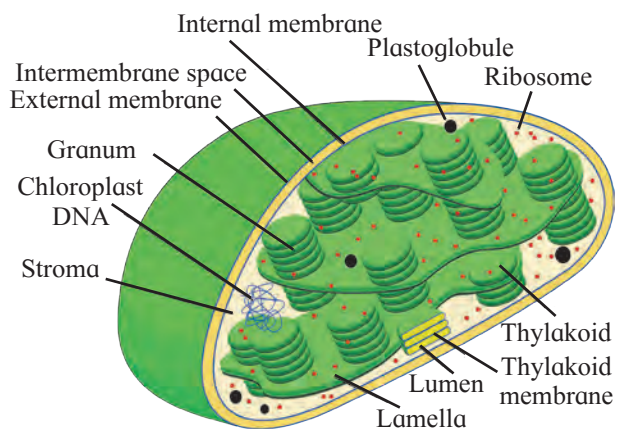
### Oxysomes :

Inner membrane of mitochondria bears numerous particles - Oxysomes (F<sub>1</sub>-F<sub>0</sub> / Fernandez - Moran / Elementary particles / mitochondrial particles). Each particle consists of head and stalk / foot. Head (F<sub>1</sub>) / lollipop head faces towards matrix and foot (F<sub>0</sub>) is embedded in inner membrane. Head acts as an enzyme ATP synthase and foot as proton channel. Oxysomes are involved in proton pumping and ATP synthesis.

## 10. Plastids :

Like mitochondria, plastids too are double membraned organelles containing DNA, RNA and 70S ribosomes. But they are larger in size and can be observed under light microscope. Plastids are classified according to the pigments present in it as leucoplasts, chromoplasts and chloroplasts.

Leucoplasts do not contain any pigments, they are of various shapes and sizes. These are meant for storage of nutrients. e.g. Amyloplasts that store starch, Elaioplasts that store oils and Aleuoplasts that store proteins.



**Fig. 5.13 Chloroplast**

**Something interesting :** Both mitochondria and chloroplast are double walled organelles, they have DNA and ribosomes and can duplicate within the cell on their own! It is considered that primitive eukaryotic cell engulfed an aerobic nonphotosynthetic prokaryotic cell. This guest cell developed symbiotic relationship with the host cell. In course of evolution, both merged as a single cell with a mitochondrion. One of these cells might have engulfed photosynthetic prokaryote and evolved into photosynthetic eukaryotic cells. This is called 'Endosymbiont theory' i.e. coexistence of cell within cell!

Chromoplasts contain pigments like carotene and xanthophyll, etc. They impart red, yellow or orange colour to flowers and fruits. Now you must have understood why potato looks white in colour and shoe flower petals are red. Both leucoplasts and amyloplasts do not contain photosynthetic apparatus we find in chloroplasts. Let us now study the chloroplast in details.

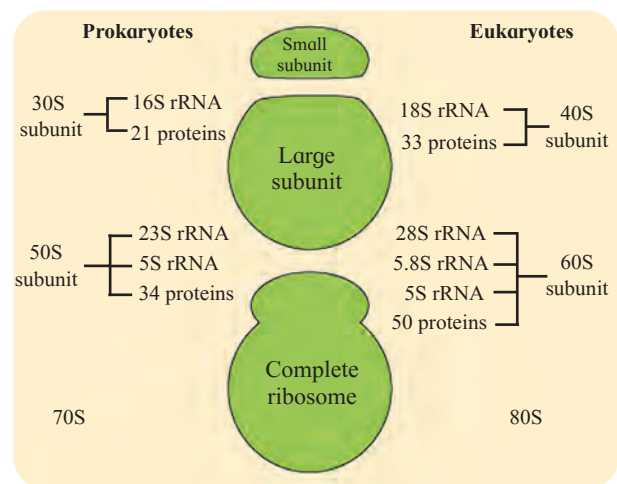
Plant cells, cells of algae and few protists like *Euglena* contain chloroplasts. You have observed ribbon shaped chloroplast in *Spirogyra*. It differs in size, number and shape in various cells in which it is found. In plants, it is found in green regions; mainly in mesophyll of leaf. This chloroplast is lens shaped. But it can also be oval, spherical, discoid or ribbon like etc. A cell may contain single large chloroplast as in *Chlamydomonas* or there are 20 to 40 chloroplasts per cell seen in mesophyll cells. Chloroplasts contain green pigment - chlorophyll along with other enzymes that help in production of sugar by photosynthesis.

Inner membrane of double walled chlorophyll is comparatively less permeable. Inside the cavity of inner membrane, there is another set of membranous sacs called thylakoids. Thylakoids are arranged in the form of stacks called grana (singular: granum). The grana are connected to each other by means of membranous tubules called stromal

lamellae. Space outside thylakoids is filled with stroma. The stroma, and the space inside thylakoids contain various enzymes essential for photosynthesis. Like other plastids, stroma of chloroplast also contains DNA and ribosomes.

## 11. Ribosomes :

You are aware that ribosomes are protein factories of the cell. They use the genetic information to synthesise proteins. Ribosomes were first observed as dense particles in electron micrograph of a cell by scientist Pallade in 1953. Ribosomes are made up of Ribosomal RNA and proteins. They do not have any membranous covering around them.



**Fig. 5.14 Ribosome**

In a eukaryotic cell, ribosomes are present in mitochondria, plastids and in cytosol. Ribosomes in cytoplasm are either found attached to outer surface of Rough Endoplasmic Reticulum and nuclear membrane or freely suspended in cytoplasm. Both are similar in structure and are 80S type. Each ribosome is made up of two subunits; a large and a small subunit.

Bound ribosomes generally produce proteins that are transported outside the cell after processing in ER and Golgi body. e.g. Bound ribosomes of acinar cells of pancreas produce pancreatic digestive enzymes. Free ribosomes come together and form chains called polyribosomes for protein synthesis.

Free ribosomes generally produce enzymatic proteins that are used up in cytoplasm like enzymes required for breakdown of sugar. Both types of ribosomes can interchange position and function. Number of ribosomes is high in cells actively engaged in protein synthesis.



### Always Remember

The particle size of ribosomes is measured in terms of Svedberg unit (S). It is a measure of sedimentation rate of a particle in an ultracentrifuge. It is thus a measure of density and size of a particle.

$$1S = 10^{-13} \text{ sec.}$$



### Know the scientists

Venkatraman Ramakrishnan : Won Nobel Prize in Chemistry in the year 2009, for explaining the structure and working of ribosomes. He shared the prize with Yonath (Israel) and Thomas Steitz (USA).

## 12. Nucleus :

Structure of nucleus of a eukaryotic cell becomes distinct in a non-dividing cell or during interphase. Such an interphase nucleus is made up of nuclear envelope, nucleoplasm, nucleolus and chromatin network.

**Nuclear envelope** is a double-layered delimiting membrane of nucleus. Two membranes are separated from each other by perinuclear space (10 to 50nm). Outer membrane is connected with endoplasmic reticulum at places. It also harbours ribosomes on it. The inner membrane on inner side is lined by nuclear lamina- a network of protein fibres that helps in maintaining shape of the nucleus. The two membranes along with perinuclear space help in separating nucleoplasm from cytoplasm. However, nuclear membrane is not continuous. At places, there are small openings called nucleopores. The nucleopores are guarded by pore complexes which regulate flow of substances from nucleus to cytoplasm and in reverse direction.

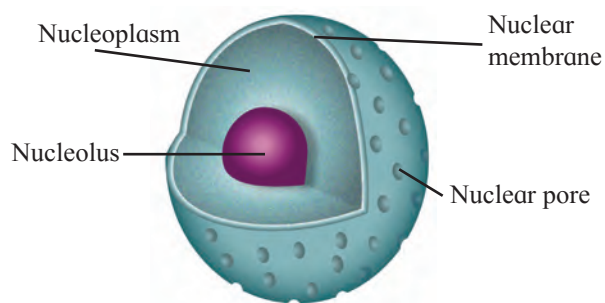


Fig. 5.15 Nucleus

The **nucleoplasm** or **karyolymph** contains various substances like nucleic acids, protein molecules, minerals and salts. It contains chromatin network and nucleolus. Nucleolus is another component which is not bound by cell membrane.

**Nucleolus** is made up of rRNA and ribosomal proteins and it is best known as the site of ribosome biogenesis. Depending on synthetic activity of a cell, there are one or more nucleoli present in the nucleoplasm. For ex: cells of oocyte contain large nucleolus whereas sperm cells contain small inconspicuous one. They appear as dense spherical bodies present near chromatin network. They produce rRNA and ribosomal proteins which are then transported to cytoplasm and are assembled together to form ribosomes.



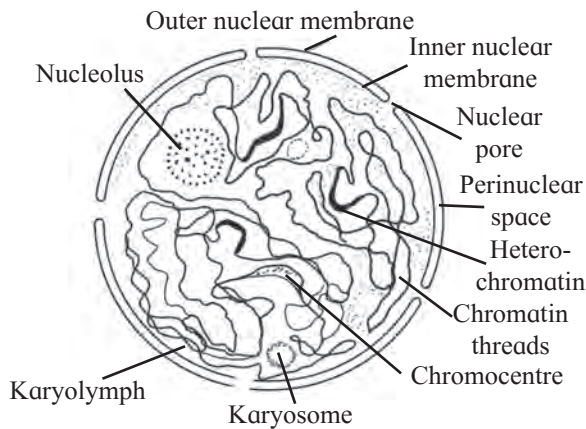
### Can you recall?

1. Consider the following cells and comment about the position, shape and number of nuclei in a eukaryotic cell. Add more examples from your previous knowledge about cell and nucleus.  
- Cuboidal epithelial cell, different types of blood corpuscles, skeletal muscle fibre, adipocyte.
2. Why nucleus is considered as control unit of a cell?
3. Can cells like Xylem or mature human RBCs be called living?
4. What is a syncytium and coenocyte?



### Chromatin material :

Nucleus contains genetic information in the form of chromosomes which are nothing but DNA molecules associated with proteins. In a nondividing cell, the chromosomes appear as thread like network and cannot be identified individually. This network is called chromatin material. The chromatin material contains DNA, histone and non-histone proteins and RNA. In some regions of chromatin, DNA is more in the extended state and it is genetically active called euchromatin. Some regions that contain more of proteins and DNA is in a highly condensed state and is genetically inert, are called heterochromatin.



**Fig. 5.16 Ultrastructure of nucleus**

When the cell prepares to divide, the chromosomes coil and get condensed. At metaphase stage, they become distinct and can be clearly identified. You will study this process as well as structure and types of chromosome in other chapters. Every species of living organism has specific number of chromosomes in their body cells like normal human cell has 46 chromosomes.

The nucleus contains entire genetic information, hence play important role in heredity and variation. It is the site for synthesis of DNA, RNA and ribosomes. It plays important role in protein synthesis. Chromosome number being constant for a species, it is important in phylogenetic studies. Nucleus thus is the master cell organelle.

### 13. Cytoskeleton :

With advancement in light and electron microscopy, scientists revealed presence of network of fibrils throughout the cytoplasm.

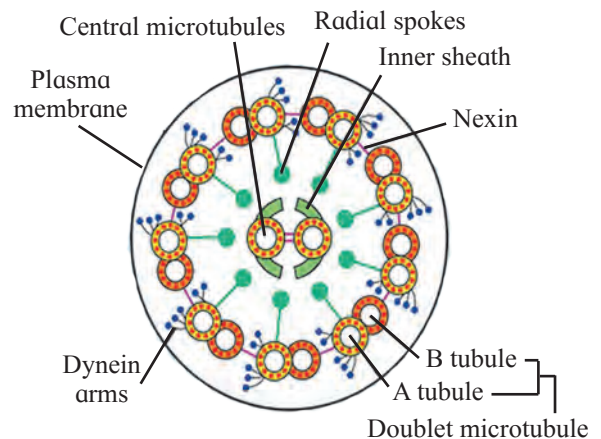
It is called cytoskeleton. Cytoskeleton consists of microtubules, microfilaments and intermediate filaments. Microtubules are made up of protein- tubulin. Microfilaments are made up of actin and intermediate filaments are composed of fibrous proteins. Cytoskeleton helps in maintenance of shape of cell, contraction of cell, mobility of cell and cell organelles, changes in shape of the cells and cell division.

### Cilia and flagella :

They are fine hair like contractile, membrane bound protoplasmic outgrowths that occur on the free surface of the cell. They generate a current in fluid medium for passage of material and locomotion. Cilia are small in size and many in number. Cilia act as oars causing co-ordinated movement of cell.

Flagella are longer and few in number. Flagella present in prokaryotic bacteria are structurally different from those of eukaryotic flagella. Cilium or flagellum consists of basal body, basal plate and shaft.

Basal body is placed in outer part of cytoplasm. It is derived from centriole. It has nine peripheral triplets of fibrils. Shaft is exposed part of cilia or flagella. It consists of two parts- **sheath** and **axoneme**. **Sheath** is covering membrane of cilium or flagellum.



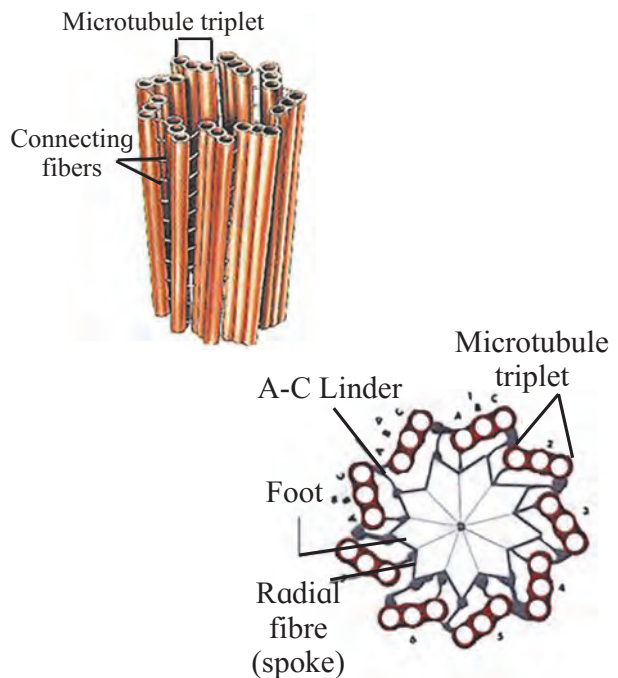
**Fig. 5.17 Structure of Cilia**

Core called **axoneme** possesses 11 fibrils running parallel to long axis. It shows 9 peripheral doublets and two single central fibrils (9+2). The central tubules are enclosed by central sheath.

This sheath is connected to one of the tubules of peripheral doublets by a radial spoke. Central tubules are connected to each other by bridges. The peripheral doublets are connected to each other through linkers or interdoublet bridge.

### Centrioles and centrosomes :

Centrosome is usually found near the nucleus of an animal cell. It contains a pair of cylindrical structures called centrioles. The cylinders are placed perpendicular to each other and are surrounded by amorphous substance called pericentriolar material. Each cylinder of centriole is made up of nine sets of triplet microtubules made up of tubulin. Evenly spaced triplets are connected to each other by means of non-tubulin proteins.



**Fig. 5.18 Structure of Centriole**

At the proximal end of centriole, there is a set of tubules called hub. The peripheral triplets are connected to hub by means of radial spokes. Due to this proximal end of centriole looks like a cartwheel. The centrosomes help in assembly of spindle apparatus during cell division. It forms basal body of cilia and flagella.

### Do Yourself

Prepare a concept map of cell structure.



## Exercise

### 1. Choose correct option

- A. Growth of cell wall during cell elongation take place by .....
- Apposition
  - Intussusception
  - Both a & b
  - Super position
- B. Cell Membrane is composed of
- Proteins and cellulose
  - Proteins and Phospholipid
  - Proteins and carbohydrates
  - Proteins, Phospholipid and some carbohydrates
- C. Plasma membrane is fluid structure due to presence of -
- Carbohydrates
  - Lipid
  - Glycoprotein
  - Polysaccharide
- D. Cell Wall is present in -
- Plant cell
  - Prokaryotic cell
  - Algal cell
  - All of the above
- E. Plasma membrane is -
- Selectively permeable
  - Permeable
  - Impermeable
  - Semipermeable
- F. Mitochondrial DNA is -
- Naked
  - Circular
  - Double stranded
  - each one of the above
- G. Which of the following set of organelles contain DNA?
- Mitochondria, Peroxisome
  - Plasma membrane, Ribosome
  - Mitochondria, Chloroplast
  - Chloroplast, Golgi body

### 2. Answer the following questions

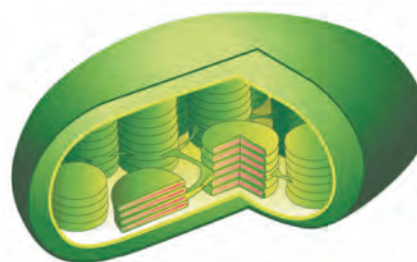
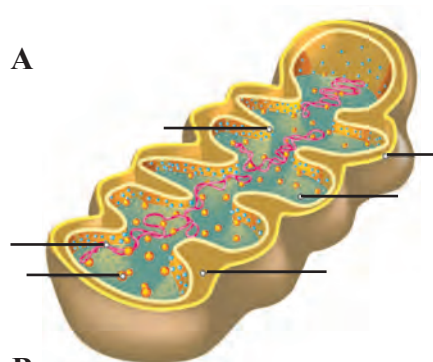
- A. Plants have no circulatory system? Then how cells manage intercellular transport?
- B. Is nucleolus covered by membrane?
- C. Fluid mosaic model proposed by Singer and Nicolson replaced Sandwich model proposed by Danielli and Davson? Why?

- D. The RBC surface normally shows glycoprotein molecules. While determining blood group do they play any role?
- E. How cytoplasm differs from nucleoplasm in chemical composition?

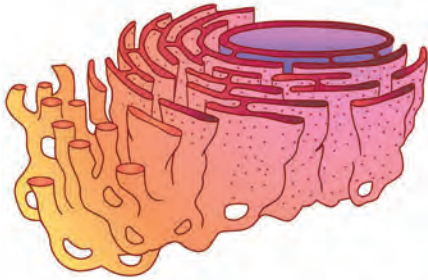
### 3. Answer the following questions

- A. Distinguish between smooth and rough endoplasmic reticulum.
- B. Mitochondria are power house of cell. Give reason.
- C. What are the types of plastids?

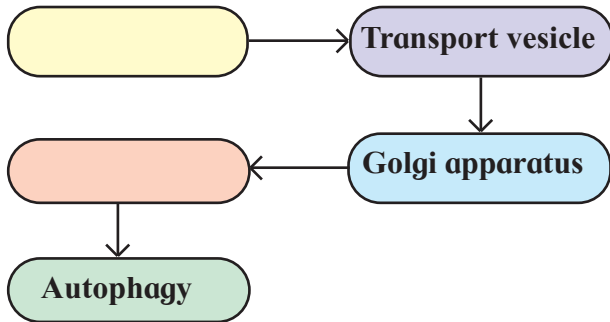
### 4. Label the diagrams and write down the details of concept in your word



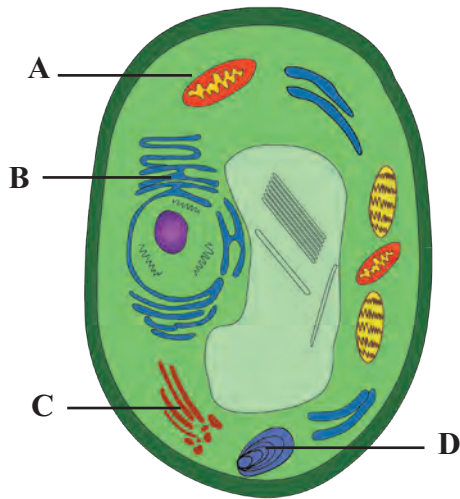
D



5. Complete the flow chart



6. Label the A, B, C, and D in above diagram and write the functions of organelles A and B.



7. Identify each cell structure or organelle from it's description below.

- i. Manufactures/ generates ribosomes
- ii. Carry out photosynthesis
- iii. Manufactures ATP in animal and plant cells
- iv. Selectively permeable

8. Onion cells have no chloroplast. How can we tell they are plants?

**Practical / Project :**

- 1. Observe the cells of Onion root tip under microscope.
- 2. Observe the cells from buccal epithelium stained with Giemsa under microscope.

## 6. Biomolecules



### Can you recall?

1. Which are different cell components?
2. What is the role of each component of cell?

Our planet is having a wide diversity of living organisms that are classified as unicellular (consisting of a single cell; including bacteria and yeast) or multicellular having many cells (e.g. plants and animals). You have also learnt that living organisms have cell as the basic structural and functional unit. The cells have protoplasm containing numerous chemical molecules, the biomolecules.

Biochemistry is biological chemistry that provides us the idea of the chemistry of living organisms and molecular basis for changes taking place in plants, animals and microbial cells. It develops the foundation for understanding all biological processes and communication within and between cells as well as chemical basis of inheritance and diseases in animals and plants.

Chemical analysis of all living organisms indicates presence of the most common elements like carbon, hydrogen, nitrogen, oxygen, sulphur, calcium, phosphorus, magnesium and others with their respective content per unit mass of a living tissue.

Chemically, all living organisms have basic three types of macromolecules, which are polymers of simple subunits called monomers. The polysaccharides (carbohydrates), polypeptides (proteins) and polynucleotides (nucleic acids) are the polymers of monosaccharides, amino acids and nucleotides respectively (Figure 6.1). Lipids are water insoluble and small molecular weight compounds as compared to macromolecules.

### 6.2 Biomolecules in the cell

#### A. Carbohydrates :

The word carbohydrates means 'hydrates of carbon'. They are also called saccharides. They are biomolecules made from just three elements: carbon, hydrogen and oxygen with the general formula  $C_x(H_2O)_y$ . They contain hydrogen and oxygen in the same ratio as in water (2:1). Carbohydrates can be broken down (oxidized) to release energy.

Based on number of sugar units, carbohydrates are classified into three types namely, monosaccharides, disaccharides and polysaccharides (Table 6.2).

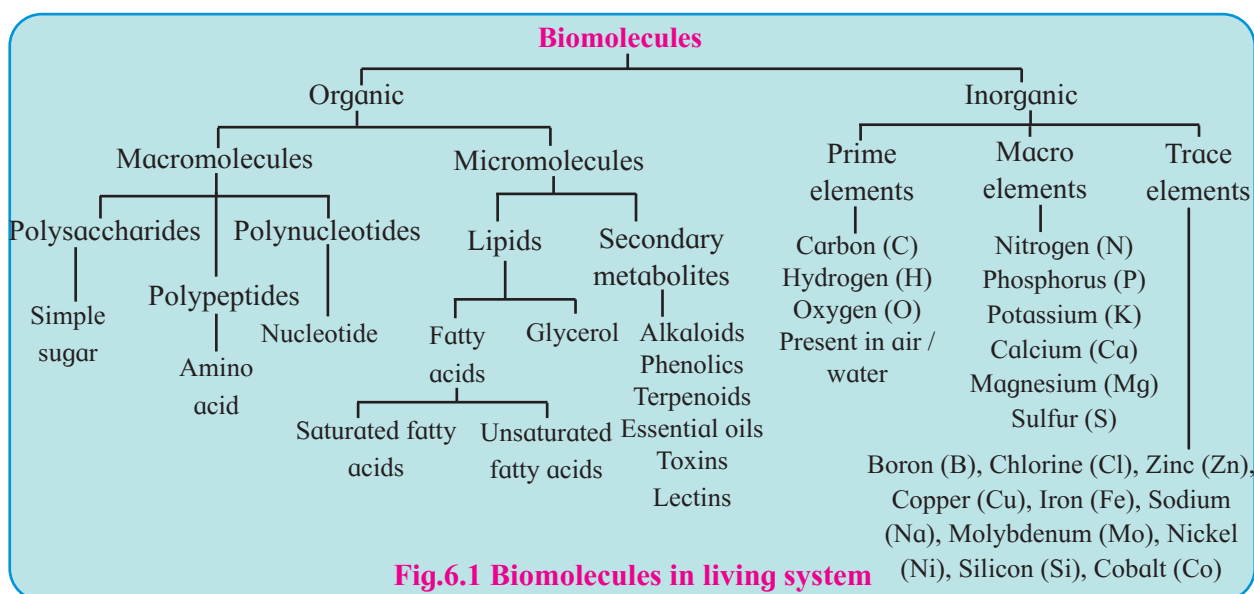


Fig.6.1 Biomolecules in living system

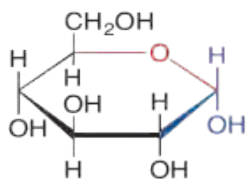
## Carbohydrates

Monosaccharides	Disaccharides	Polysaccharides
<p>(Simple sugars)</p> <ol style="list-style-type: none"> <li>1. <b>Triose</b>-3 carbons (e.g. Glyceraldehyde)</li> <li>2. <b>Tetrose</b>-4 carbons (e.g. Erythrose)</li> <li>3. <b>Pentose</b>-5 carbons (e.g. Ribose in RNA and deoxyribose in DNA)</li> <li>4. <b>Hexose</b>- 6 carbons (e.g. Glucose- blood sugar, Fructose-fruit sugar and Galactose-product of lactose)</li> <li>5. <b>Heptose</b>-7 carbons (e.g. Sedoheptulose)</li> </ol>	<p>(Two monosaccharides)</p> <ol style="list-style-type: none"> <li>1. <b>Sucrose</b> (cane sugar) on hydrolysis, it produces Glucose and Fructose</li> <li>2. <b>Lactose</b> (milk sugar) on hydrolysis, it produces Glucose and Galactose</li> <li>3. <b>Maltose</b> (malt sugar) on hydrolysis, it produces two units of Glucose</li> </ol>	<p>(Polymer of monosaccharides)</p> <ol style="list-style-type: none"> <li>a. <b>Homopolysaccharides:</b> polymer of one type of monosaccharides e.g. <b>Starch</b> - plant storage molecule e.g. <b>Cellulose</b> - cell wall component e.g. <b>Glycogen</b> - animal storage molecule</li> <li>b. <b>Heteropolysaccharides:</b> polymer of different types of monosaccharides e.g. Hyaluronic acid, heparin, blood group substances, chondroitin sulphate</li> </ol>

**Table 6.2 Classification of Carbohydrates**

**1. Monosaccharides :** These are the simplest sugars having crystalline structure, sweet taste and are soluble in water. They cannot be further hydrolysed into smaller molecules. They are the building blocks or monomers of complex carbohydrates. They have the general molecular formula  $(CH_2O)_n$ , where n can be 3, 4, 5, 6 and 7. They can be classified as triose, tetrose, pentose, etc. according to the number of carbon atoms in a molecule as mentioned in the table 6.2.

Monosaccharides containing the aldehyde (-CHO) group are classified as **aldoses** e.g. glucose, xylose, and those with



**Fig. 6.3 Structure of Glucose**

All monosaccharides are reducing sugars due to presence of free aldehyde or ketone group. These sugars reduce the Benedict's reagent ( $Cu^{2+}$  to  $Cu^+$ ) since they are capable of transferring hydrogens (electrons) to other compounds, a process called reduction.

a ketone ( $-C=O$ ) group are classified as **ketoses**. eg. ribulose, fructose.

**a. Glucose :** It is the most important fuel in living cells. Its concentration in the human blood is about 90mg per 100ml of blood. The small size and solubility in water of glucose molecules allows them to pass through the cell membrane into the cell. Energy is released when the molecules are metabolised by cellular respiration.

**b. Galactose :** It looks very similar to glucose molecules. They can also exist in  $\alpha$  and  $\beta$  forms. Galactose react with glucose to form the disaccharide **lactose**. However, glucose and galactose cannot be easily converted into one another. Galactose cannot play the same role in respiration as glucose.

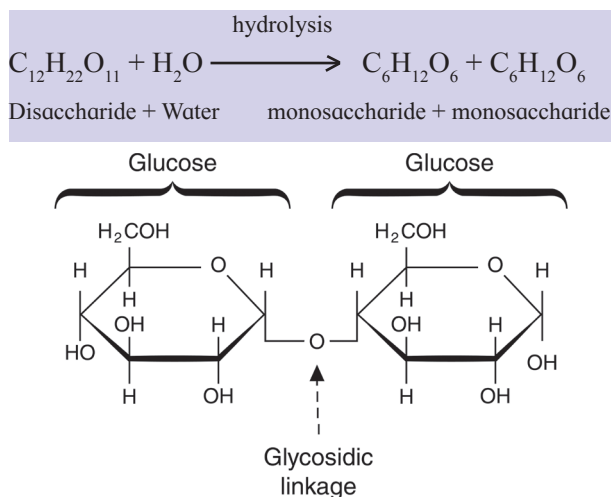
**c. Fructose :** It is the fruit sugar and chemically it is ketohexose but it has a five-atom ring rather than a six-atom ring. Fructose reacts with glucose to form the sucrose, a disaccharide.

**2. Disaccharides :** Monosaccharides are rare in nature. Most sugars found in nature are disaccharides. Disaccharide is formed when two monosaccharide react by condensation

reaction releasing a water molecule. This process requires energy. A glycosidic bond forms and holds the two monosaccharide units together.

Sucrose, lactose and maltose are examples of disaccharides. Sucrose is a non-reducing sugar since it lacks free aldehyde or ketone group. Lactose and maltose are reducing sugars. Lactose also exists in beta form, which is made from  $\beta$ -galactose and  $\beta$ -glucose.

Disaccharides are soluble in water, but they are too big to pass through the cell membrane by diffusion. They are broken down in the small intestine during digestion. Thus formed monosaccharides then pass into the blood and through cell membranes into the cells.



**Fig. 6.4 Maltose**

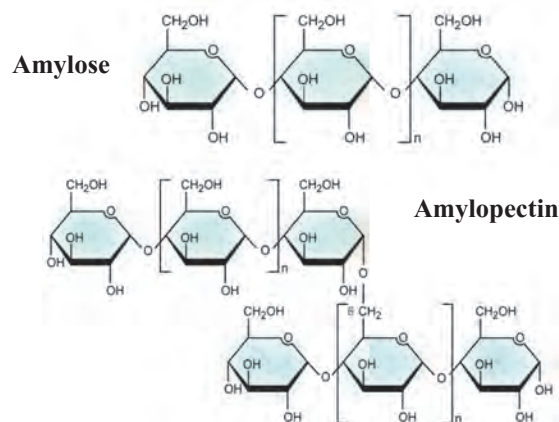
Monosaccharides are used very quickly by cells but if a cell is not in need of all the energy released immediately, then it may get stored. Monosaccharides are converted into disaccharides in the cell by condensation reactions, which result in the formation of polysaccharides as macromolecules. These are too big to escape from the cell.

### 3. Polysaccharides :

Monosaccharides can undergo a series of condensation reactions, adding one unit after the other to the chain till a very large molecule (polysaccharide) is formed. This is called **polymerization**. Polysaccharides are broken down by hydrolysis into

monosaccharides. The properties of a polysaccharide molecule depend on its length, branching, folding and coiling.

**a. Starch :** Starch is a stored (Reserve) food in the plants. It exists in two forms: amylose and amylopectin. Both are made from  $\alpha$ -glucose. Amylose is an unbranched polymer of  $\alpha$ -glucose. The molecules coil into a helical structure. It forms a colloidal suspension in hot water. Amylopectin is a branched polymer of  $\alpha$ -glucose. It is completely insoluble in water.



**Fig. 6.5 Starch**

**b. Glycogen :** It is amylopectin with very short distances between the branching side-chains. Glycogen is stored in animal body particularly in liver and muscles from where it is hydrolysed as per need to produce glucose.

**c. Cellulose :** It is a polymer made from  $\beta$ -glucose molecules and the polymer molecules are 'straight'. Cellulose serves to form the cell walls in plant cells. These are much tougher than cell membranes. This toughness is due to the arrangement of glucose units in the polymer chain and the hydrogen-bonding between neighbouring chains.

### Biological significance of Carbohydrates:

It supplies energy for metabolism. Glucose is the main substrate for ATP synthesis. Lactose, a disaccharide is present in milk provides energy to lactating babies. Polysaccharide serves as structural component of cell membrane, cell wall and reserve food as starch and glycogen.



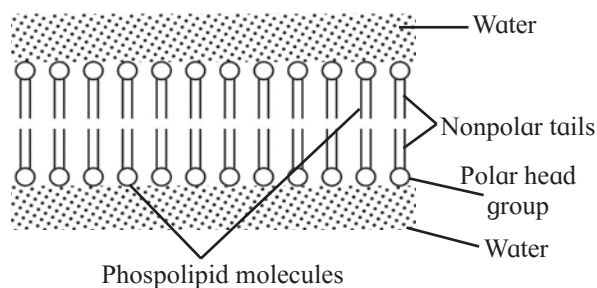


Waxes form water insoluble coating on hair and skin in animals, waxes form an outer coating on stems, leaves and fruits.



**Fig. 6.8 Wax in bee hive**

**Compound lipids :** These are ester of fatty acids containing other groups like phosphate (Phospholipids), sugar (glycolipids), etc. They contain a molecule of glycerol, two molecules of fatty acids and a phosphate group or simple sugar. Some phospholipids such as lecithin also have a nitrogenous compound attached to the phosphate group. Phospholipids have both hydrophilic polar groups (phosphate and nitrogenous group) and hydrophobic non-polar groups (hydrocarbon chains of fatty acids). Phospholipids contribute in the formation of cell membrane. Glycolipids contain glycerol, fatty acids, simple sugars such as galactose. They are also called cerebrosides. Large amounts of them have been found in the brain white matter and myelin sheath.



**Fig. 6.9 Lipid bilayer in aqueous medium**

**Sterols :** They are derived lipids. They are composed of fused hydrocarbon rings (steroid nucleus) and a long hydrocarbon side chain. One of the most common sterol is cholesterol. It is widely distributed in all cells of the animal body, but particularly in nervous tissue. Cholesterol exists either free or as cholesterol ester.

Adrenocorticoids, sex hormones (progesterone, testosterone) and vitamin D are synthesised from cholesterol. Cholesterol is not found in plants. In plants, sterols exist chiefly as Phytosterols. Yam Plant (*Dioscorea*) produces a steroid compound called diosgenin. It is used in the manufacture of antifertility pills. i.e. birth control pills.



#### Find out

1. Why do high cholesterol level in the blood cause heart diseases?
2. Polyunsaturated fatty acids are believed to decrease blood cholesterol level. How?



#### Can you tell?

1. Differentiate between the saturated and unsaturated fats.
2. What are lipids? Classify them and give at least one example of each.

### C. Proteins :

The term 'protein' (Gk. proteious meaning first or of primary importance) was suggested by Berzelius (1830). Mulder adopted the term protein to refer to the complex organic nitrogenous substances found in the cell of all animals and plants.

**Characteristics :** Proteins are large molecules containing amino acid units (building blocks) ranging from 100 to 3000. Proteins have high molecular weights. In proteins, amino acids are linked together by peptide bonds which join the carboxyl group of one amino acid residue to the amino group of another residue. A protein molecule consists of one or more polypeptide chains. Proteins can contain any or all of the 20 naturally occurring amino acid types.

The linear sequence of amino acids in polypeptide chain of a protein forms its primary structure. Functional proteins have 3-dimensional conformation. Some proteins such as keratin of hair consists of polypeptide chain arranged like a spiral helix.

Such spirals are in some cases right-handed called  $\alpha$ -helix, in others left-handed called  $\beta$ -helix. The spiral configuration is held together by hydrogen bonds. The sequence of amino acids in the polypeptide chain also determines the location of its bend or fold and the position of formation of hydrogen bonds between different portions of the chain or between different chains. Due to formation of hydrogen bonds peptide chains assume a secondary structure.

In some proteins, two or more peptide chains are linked together by intermolecular hydrogen bonds. Such structures are called pleated sheet. Pleated sheet structure is found in protein of silk fibres. In large proteins such as myoglobin and enzymes, peptide chains are much looped, twisted and folded back on themselves due to formation of disulphide bonds. Such loops and bends give the protein a tertiary structure. Whereas in haemoglobin, protein subunits are held together to form quaternary structure.

Proteins are extremely reactive and highly specific in behaviour. Proteins are amphoteric in nature i.e. they act as both acids and bases. The behaviour of proteins is strongly influenced by pH. Like amino acids, proteins are dipolar ions at the isoelectric point i.e. the sum of the positive charges is equal to the sum of the negative charges and the net charge is zero. The ionic groups of a protein are contributed by the side chains of the polyfunctional amino acids. A protein consists of more basic amino acids such as lysine and arginine exists as a cation at the physiological pH of 7.4. Such proteins are called basic proteins. Histones of nucleoproteins are basic proteins. A protein rich in acidic amino acids exists as an anion at the physiological pH. Such proteins are called acidic proteins. Most of the blood proteins are acidic proteins.

### Classification of proteins :

On the basis of structure, proteins are classified into three categories:

**Simple proteins :** Simple proteins on hydrolysis yield only amino acids. These are soluble in one or more solvents. Simple proteins may be soluble in water. Histones of nucleoproteins are soluble in water. Globular molecules of histones are not coagulated by heat. Albumins are also soluble in water but they get coagulated on heating. Albumins are widely distributed e.g. egg albumin, serum albumin and legumelin of pulses are albumins.

**Conjugated proteins :** Conjugated proteins consist of a simple protein united with some non-protein substance. The non-protein group is called prosthetic group e.g. haemoglobin. Globin is the protein and the iron containing pigment haem is the prosthetic group. Similarly, nucleoproteins have nucleic acids coupled with histone proteins. On this basis, proteins are classified as glycoproteins and mucoproteins. Mucoproteins are carbohydrate-protein complexes e.g. mucin of saliva and heparin of blood. Lipoproteins are lipid-protein complexes e.g. conjugate protein found in brain, plasma membrane, milk etc.

**Derived proteins :** These proteins are not found in nature as such. These proteins are derived from native protein molecules on hydrolysis. Metaproteins, peptones are derived proteins.



### Can you tell?

1. All proteins are made up of the same amino acids; then how proteins found in human beings and animals may be different from those of other ?
2. What are conjugated proteins? How do they differ from simple ones? Give one example of each.
3. Which of the following is a simple protein
  - a. nucleoprotein
  - b. mucoprotein
  - c. chromoprotein
  - d. globulin

## D. Nucleic Acids :



### Know the scientists

Swiss biochemist, Friederich Miescher (1869) discovered and isolated nucleic acids from the pus cells. By 1938, it became evident that nucleic acids are of two types- deoxyribose nucleic acid (DNA) and ribose nucleic acid (RNA). DNA is found in chloroplasts and mitochondria. DNA is the hereditary material in most of the organisms. The nucleic acids are among the largest of all molecules found in living beings. They contain three types of molecules a) 5 carbon sugar, b) Phosphoric acid and c) Nitrogen containing bases. Three join together to form a nucleotide of nucleic acid.

Fuelgen (1924) showed that chromosomes contain DNA. He established that nucleic acids contain two pyrimidine (cytosine and thymine) and two purine (adenine and guanine) bases. Wilkins and co-workers showed that the purine and pyrimidine bases are placed regularly along the DNA molecules at a distance of  $3.4 \text{ \AA}$ , DNA is composed of: **Sugar molecule** (It is a pentose sugar of deoxyribose type) **Phosphoric acid** (also called phosphates when in chemical combination) **Nitrogen containing bases** (these are nitrogen containing organic ring compounds). Principally bases are of two types: (a) pyrimidine bases (b) purine bases

Pyrimidine bases are single ring (monocyclic) nitrogenous bases. **Cytosine**, **Thymine** and **Uracil** are pyrimidines. Purine are double ring (dicyclic) nitrogenous bases **Adenine** and **guanine** are purines.

Erwin Chargaff (1950) estimated the relative amounts of the four nitrogenous bases viz. adenine, thymine, cytosine and guanine in DNA. He observed that the pyrimidine and purine always occur in equal amount in DNA. He also found that the base ratio i.e.  $A+T / G+C$  may vary in the DNA of different groups of animals and plants but  $A+T / G+C$  ratio remains constant for a particular species.

## 1. Structure of DNA :

DNA is a very long chain made up of alternate sugar and phosphate groups. The sugar is always deoxyribose and it always joined to the phosphate in the same way, so that the long chain is perfectly regular, repeating the same phosphate-sugar sequence over and over again. Each sugar of the sugar-phosphate chain has a 'base' attached to it and the base is not always the same. This unit which consists of a sugar, phosphate and a base is called **nucleotide**. The nitrogenous base and a sugar of a nucleotide together form a molecule, nucleoside. Thus, nucleoside does not contain phosphate group. Four types of nucleosides are found in DNA molecule. In a nucleoside, nitrogenous base is attached to the first carbon atom (C-1) of the sugar and when a phosphate group gets attached with that of the carbon (C-5) atom of the sugar molecule a nucleotide molecule is formed.

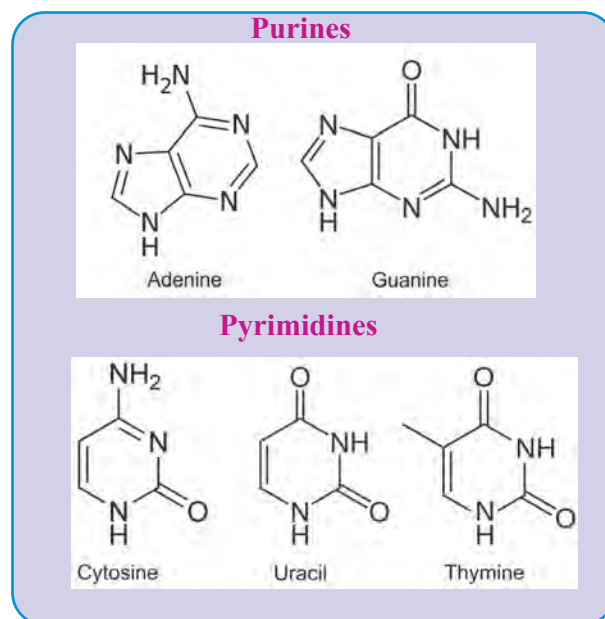
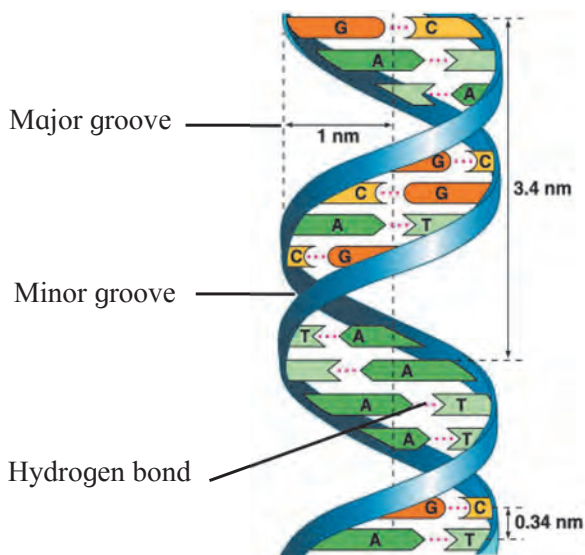


Fig. 6.10 Nitrogen bases in Nucleic acid

A single strand of DNA consists of several thousands of nucleotides linked one above the other. The phosphate group of the lower nucleotide attached with the 5<sup>th</sup> carbon atom of the deoxyribose sugar forms phosphodi-ester bond with that of the, 3<sup>rd</sup> carbon atom of the deoxyribose sugar of the nucleotide placed just above it.



**Fig. 6.11 Structure of DNA**

Single long chain of polynucleotides of DNA consists of one end with sugar molecules not connected with another nucleotide having C-3 carbon not connected with phosphate group, similarly the other end having C-5 of the sugar is not connected with any more phosphate group. These two ends of the polynucleotide chain are called as 3' and 5' ends respectively. The single polynucleotide strand of DNA is not straight but helical in shape. The DNA molecule consists of such two helical polynucleotide chains which are complementary to each other. The two complementary polynucleotide chains of DNA are held together by the weak hydrogen bonds. Adenine always pairs with thymine, and guanine with cytosine (a purine with a pyrimidine). Adenine-thymine pair consists of two hydrogen bonds and guanine-cytosine pair consists of three hydrogen bonds (Thus, if the sequence of bases of a polynucleotide chain is known, that of the other can then be determined).



**Do you know ?**

Watson and Crick did not conduct any experiment on DNA. Crick was expert in physics, X-ray crystallography and Watson in viral and bacterial genetics. They only analyzed and comprehended the results of experiments performed by scientists like R. Franklin, M. Wilkins, etc.

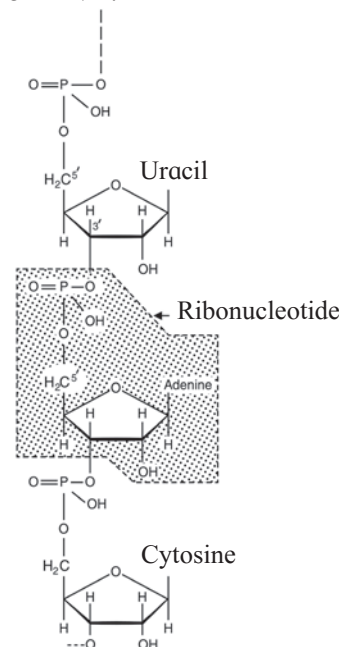
**DNA Model :**

According to Watson and Crick, DNA molecule consists of two strands twisted around each other in the form of a double helix. The two strands i.e. polynucleotide chains are supposed to be in opposite direction (antiparallel) so end of one chain having 3' lies beside the 5' end of the other. One turn of the double helix of the DNA measures about  $34\text{\AA}$ . It consists paired nucleotides and the distance between two neighbouring pair nucleotides is  $3.4\text{\AA}$ . The diameter of the DNA molecule has been found to be  $20\text{\AA}$ .

There are certain organisms like Bacteriophage  $\phi$  x 174 and several bacterial viruses which possess single stranded DNA.

**2. Ribonucleic Acid (RNA) :**

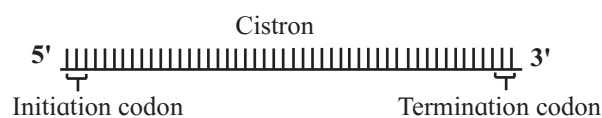
Another nucleic acid found in the living organisms is Ribose nucleic acid. In most of the organisms it is not found to be hereditary material but in certain organisms like tobacco mosaic virus, it is the hereditary material. Like DNA, ribose nucleic acid also consists of polynucleotide chain with the difference that it consists of single strand. In some cases e.g. Reovirus and wound tumour virus, RNA is double stranded. The nucleotides of RNA have ribose sugar instead of the deoxyribose sugar as in the case of DNA.



**Fig. 6.12 Single strand of RNA**

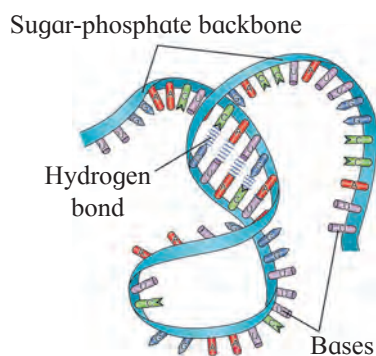
In case of RNA, Uracil substitutes thymine of DNA. Purine, pyrimidine equality is not found in RNA molecule because of its single stranded structure. RNA strand is usually found folded upon itself in certain regions or entirely. These foldings helps in stability of the RNA molecule. Most of the RNA polynucleotide chains start either with adenine or guanine. Three types of cellular RNAs have been distinguished: (a) messenger RNA (mRNA) or template RNA, (b) ribosomal RNA (rRNA), (c) transfer RNA (tRNA) or soluble RNA.

**mRNA** carries genetic information for arranging amino acids in definite sequence. It is a linear polynucleotide. It accounts 3% of total cellular RNA. Its molecular weight is several million. mRNA molecule carrying information to form a complete polypeptide chain is called cistron. Size of mRNA is related to the size of message it contains. Synthesis of mRNA begins at 5' end of DNA strand and terminates at 3' end.



**Fig. 6.13 The mRNA**

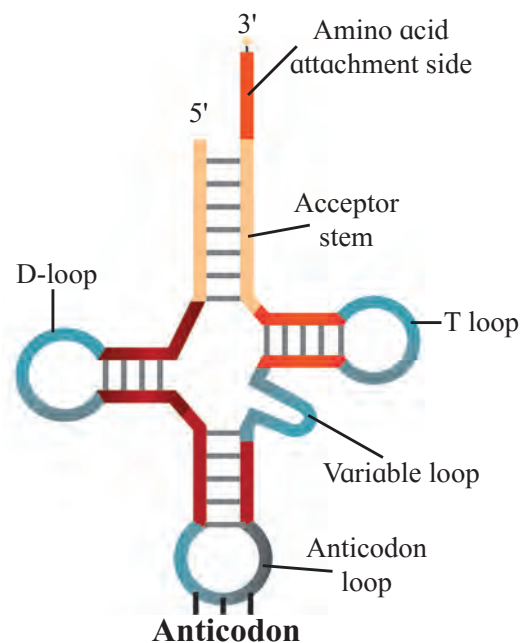
**rRNA** form 50-60% part of ribosomes. It accounts 80-90% of the cellular RNA. It is synthesized in nucleus. Kurland (1960) discovered it. It gets coiled here and there due to intrachain complementary base pairing.



**Fig. 6.14 The rRNA**

**tRNA** molecules are much smaller consisting of 70-80 nucleotides.

It is also single stranded but folded due to number of complementary base sequences after pairing, it is shaped like clover-leaf (Holley,1965). Each tRNA can pick up particular amino acid. Following four parts can be recognized on tRNA 1) **DHU arm** (Dihydroxyuridine loop/amino acid recognition site) 2) **Amino acid binding site** 3) **Anticodon loop** / codon recognition site 4) **Ribosome recognition site**. In the anticodon loop of tRNA, three unpaired nucleotides are present, called as anticodon which pair with complementary codon present on mRNA. The specific amino acids is attached at the 3' end in acceptor stem of clover leaf of tRNA.



**Fig. 6.15 The tRNA**



**Can you tell?**

- Describe the structure of DNA molecule as proposed by Watson and Crick.
- Difference between DNA and RNA is because of
  - sugar and base
  - sugar and phosphate
  - phosphate and base
  - sugar only
- Differentiate between DNA and RNA.
- What is nucleotide? How is it formed? Mention the names of all nucleotides.

## E. Enzymes :

Thousands of different chemical reactions take place automatically at a given time in a tiny living cell. The reactions take place at the body temperature. If these enzymes were not present in the cell, either the reactions would not occur or if they occur they would occur at a very very slow rate.



### Know the scientists

German chemist Edward Buchner discovered enzymes by accident. Buchner discovered that living cells were not necessary but that yeast extract could bring about fermentation. He then coined the term Enzyme (Gk. En = in, zyma = yeast i.e. in yeast). This term is now commonly used for all biocatalysts.

Each enzyme catalyzes a small number of reactions, specifically perhaps only one. The substance upon which an enzyme acts is termed as the substrate. The enzymes which act within the cell in which they are synthesized are known as endo-enzymes e.g., enzymes produced in the chloroplast and mitochondria, if they act outside the cell in which they are synthesized, they are known as exo-enzymes e.g., enzymes released by many fungi. These enzymes, synthesised by living cell, retain their catalytic property even when extracted from cells.



### Do you know ?

Rennet tablets used for coagulating milk protein casein (cheese) contain renin enzyme that is obtained from the stomach of calf.

### Nature of Enzymes :

On the basis of chemical composition, enzymes can be put into two categories.

(i) **Purely proteinaceous enzymes** e.g. proteases that split protein (ii) **Conjugated enzymes** are made up of a protein to which a non-protein prosthetic group is attached.

The prosthetic group is firmly bound to the protein component by chemical bonds and is not removed by hydrolysis. If the prosthetic group is removed the protein part of the enzyme becomes inactive. Proteinous part of enzyme is called apoenzyme. Apoenzyme with prosthetic group together forms, holoenzyme.

There are enzymes which require certain organic compounds and inorganic ions for their activity. The organic compounds that are tightly attached to the protein part are called co-enzymes whereas the inorganic ions which are loosely attached to the protein part are called co-factors. Some of the organic co-enzymes are nicotinamide-adenine-dinucleotide (NAD) and flavin mononucleotide (FMN). Inorganic ions of metals which act as co-factors include magnesium, copper, zinc, iron, manganese etc. Iron ( $\text{Fe}^{++}$ ) is a co-factor of enzyme catalase, manganese is a co-factor of peptidases. Often metal co-factors are referred to as enzyme activators.

### Properties of Enzymes :

**Proteinaceous Nature :** All enzymes are basically made up of protein except ribozymes.

**Three-Dimensional conformation :** All enzymes have specific 3-dimensional conformation. They have one or more active sites to which substrate (reactant) combines. The points of active site where the substrate joins with the enzyme is called substrate-binding site.

**Catalytic Property :** Enzymes are like inorganic catalysts and influence the speed of biochemical reactions but themselves remain unchanged. After completion of the reaction and release of the product they remain active to catalyse again.

A small quantity of enzymes can catalyse the transformation of a very large quantity of the substrate into an end product. For example, sucrase can hydrolyse 100000 times of sucrose as compared with its own weight.

**Specificity of action :** The ability of an enzyme

to catalyse one specific reaction and essentially no other is perhaps its most significant property.

Each enzyme acts upon a specific substrate or a specific group of substrates. Enzymes are very sensitive to temperature and pH. Each enzyme exhibits its highest activity at a specific pH, called optimum pH. Any increase or decrease in pH causes decline in enzyme activity e.g. enzyme pepsin (secreted in stomach) shows highest activity at an optimum pH of 2 (acidic). Trypsin (in duodenum) is most active at an optimum pH of 9.5 (alkaline). Both these enzymes viz. pepsin and trypsin are protein digesting enzymes.

**Temperature :** Enzymes are denatured or destroyed at higher temperature of 60-70°C. Below 4°C temperature they are not destroyed but become inactive. This inactive state is temporary and the enzyme can become active at suitable temperature. Most of the enzymes work at an optimum temperature between 20°C and 35°C.

### Nomenclature of Enzymes :

There are various ways of naming enzymes. Enzymes are named by adding the suffix-'ase' to the name of the substrate on which they act e.g. protease, sucrase, nuclease etc. which break up proteins, sucrose and nucleic acids respectively.

The enzymes can be named according to the type of function they perform e.g. dehydrogenase remove hydrogen, carboxylase add CO<sub>2</sub> decarboxylases remove CO<sub>2</sub>, oxidases helping in oxidation etc.

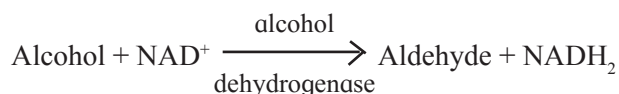
Some enzymes are named according to the source from which they are obtained e.g. papain from papaya, bromelain from the member of Bromeliaceae family, pineapple.

According to international code of enzyme nomenclature, the name of each enzyme ends with an -ase and consists of double name. The first name indicates the nature of substrate upon which the enzyme acts and the second name indicates the reaction catalysed e.g. pyruvic decarboxylase catalyses the removal of CO<sub>2</sub> from the substrate pyruvic

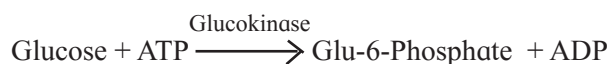
acid. Similarly, the enzyme glutamate pyruvate transaminase catalyses the transfer of an amino group from the substrate glutamate to another substrate pyruvate.

### Classification of Enzymes :

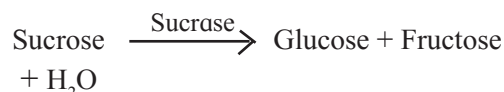
**Oxidoreductases :** These are enzymes catalyzing oxidation and reduction reactions by the transfer of hydrogen and/or oxygen. e.g. alcohol dehydrogenase



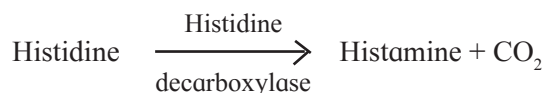
**Transferases :** These enzymes catalyse the transfer of certain groups between two molecules. e.g. glucokinase



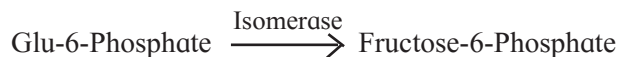
**Hydrolases:** These are enzymes catalyse hydrolytic reactions. This class includes amylases, proteases, lipases etc. eg. Sucrase



**Lyases :** These enzymes are involved in elimination reactions resulting in the removal of a group of atoms from substrate molecule to leave a double bond. It includes aldolases, decarboxylases, and dehydratases, e.g. fumarate hydratase.

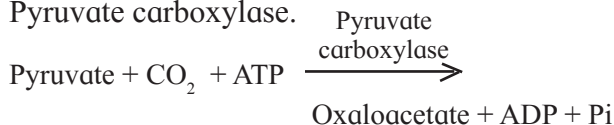


**Isomerases :** These enzymes catalyze structural rearrangements within a molecule. Their nomenclature is based on the type of isomerism. Thus these enzymes are identified as racemases, epimerases, isomerases, mutases, e.g. xylose isomerase.



**Ligases or Synthetases :** These are the enzymes which catalyse the covalent linkage of the molecules utilizing the energy obtained from hydrolysis of an energy-rich compound

like ATP, GTP e.g. glutathione synthetase, Pyruvate carboxylase.



### Can you tell?

- Which enzyme is needed to digest food reserve in castor seed?
  - amylase
  - diastase
  - lipase
  - protease
- Co-enzyme is -----
  - often a metal
  - often a vitamin
  - always as organic molecule
  - always an inorganic molecule
- List the important properties of enzymes.
- Name the chemical found in the living cell which has necessary message for the production of all enzymes required by it.



### Try this

To demonstrate the effect of heat on the activities of inorganic catalysts and enzymes.

**Procedure :** Take 2 ml of hydrogen peroxide ( $\text{H}_2\text{O}_2$ ) in two test tubes, Add a pinch of manganese dioxide ( $\text{MnO}_2$ ) powder to one and a small piece of potato (to provide enzyme catalase) or fresh liver (to provide enzyme peroxidase) to other test tube. Keep the tubes at room temperature in summer and at  $38^\circ\text{C}$  in winter. You will find that bubbles of oxygen evolve in both the test tubes. Both  $\text{MnO}_2$  and cellular enzymes (catalase or peroxidase) cause breakdown of  $\text{H}_2\text{O}_2$  and evolution of oxygen. Now take two fresh test tubes and repeat the experiment. This time, use boiled and cooled manganese dioxide and the liver/potato piece. You will find that oxygen evolves in the hydrogen peroxide solution containing boiled and cooled manganese dioxide. But oxygen does not evolve in the other tube containing boiled and cooled liver/potato piece. This activity confirms that heat does not affect catalytic action of inorganic catalyst but inactivates the enzyme.

## Mechanism of enzyme action :

The basic mechanism by which enzymes catalyze chemical reactions begins with the binding of the **substrate** (or substrates) to the active site on the enzyme. The active site is the specific region of the enzyme which combines with the substrate.

The binding of the substrate to the enzyme causes changes in the distribution of electrons in the chemical bonds of the substrate and ultimately causes the reaction that lead to the formation of products. The products are released from the enzyme surface to regenerate the enzyme for another reaction cycle. There are two models to explain the mechanism of forming Enzyme-Substrate complex, as described below:

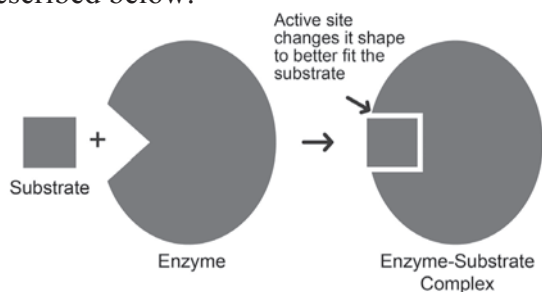


Fig. 6.16 Mechanism of enzyme action

## Lock and Key model:

The specific action of an enzyme with a single substrate can be explained using a Lock and Key analogy first postulated in 1894 by Emil Fischer. In this analogy, the lock is the enzyme and the key is the substrate. Only the correctly sized key (substrate) fits into the key hole (active site) of the lock (enzyme).

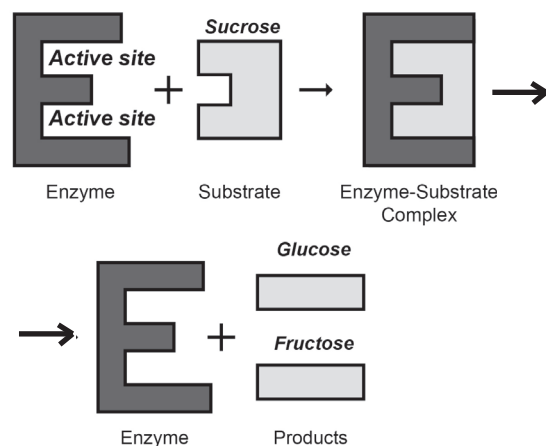
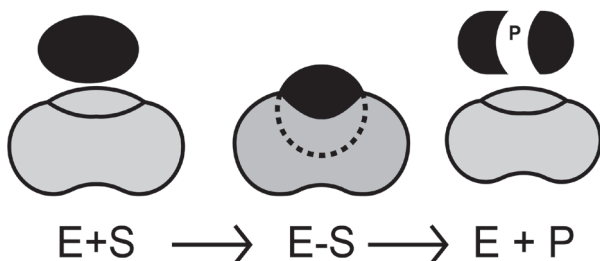


Fig. 6.17 Lock and key model



### Induced Fit model (Flexible Model):

Koshland (1959) proposed the induced fit theory, which states that approach of a substrate induces a conformational change in the enzyme. It is the more accepted model to understand mode of action of enzyme. Unlike the lock-and-key model, the induced fit model shows that enzymes are rather flexible structures in which the active site continually reshapes by its interactions with the substrate until the time the substrate is completely bound to it (it is also the point at which the final form and shape of the enzyme is determined).



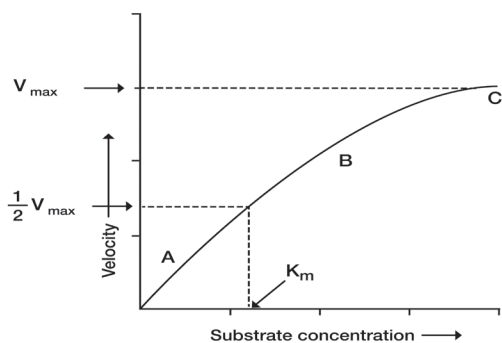
**Fig. 6.18 Complex Flexible model**

### Factors Affecting Enzyme Activity :

Following factors affect enzyme activity :

#### 1. Concentration of Substrate :

Increase in the substrate concentration gradually increases the velocity of enzyme activity within the limited range of substrate levels. A rectangular hyperbola is obtained when velocity is plotted against the substrate concentration. Three distinct phases (A, B and C) of the reaction are observed in the graph. Where  $V$  = Measured velocity,  $V_{max}$  = Maximum velocity,  $S$  = Substrate concentration,  $K_m$  = Michaelis-Menten constant.



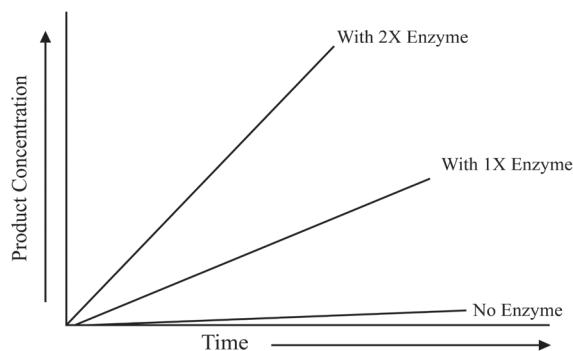
**Graph 6.19 Effect of substrate concentration on enzyme activity**

$K_m$  or the Michaelis-Menten constant is defined as the substrate concentration (expressed in moles/lit) to produce half of maximum velocity in an enzyme catalysed reaction. It indicates that half of the enzyme molecules (i.e. 50%) are bound with the substrate molecules when the substrate concentration equals the  $K_m$  value.

$K_m$  value is a constant and a characteristic feature of a given enzyme. It is a representative for measuring the strength of ES complex. A low  $K_m$  value indicates a strong affinity between enzyme and substrate, whereas a high  $K_m$  value reflects a weak affinity between them. For majority of enzymes, the  $K_m$  values are in the range of  $10^{-5}$  to  $10^{-2}$  moles.

#### 2. Enzyme Concentration :

The rate of an enzymatic reaction is directly proportional to the concentration of the substrate. The rate of reaction is also directly proportional to the square root of the concentration of enzymes. It means that the rate of reaction also increases with the increasing concentration of enzyme. And the rate of reaction can also decreased by decreasing the concentration of enzyme.

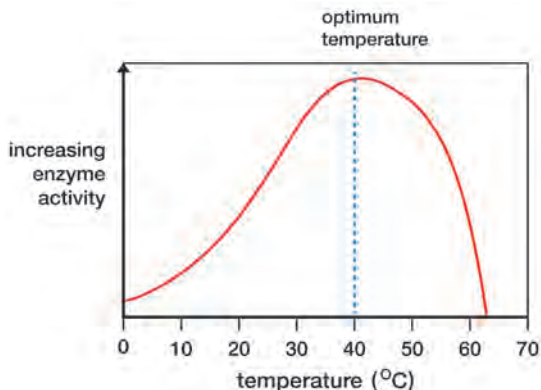


**Graph 6.20 Effect of enzyme concentration**

#### 3. Temperature :

The enzymatic reaction occurs best at or around  $37^\circ\text{C}$  which is the average normal body temperature in homeotherms. The rate chemical reaction is increased by a rise in temperature but this is true only over a limited range of temperature. Enzymes rapidly denature at temperature above  $40^\circ\text{C}$ .

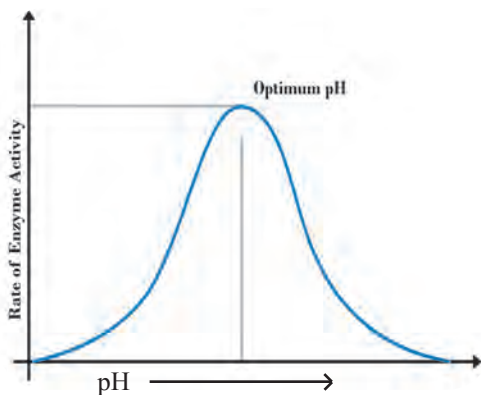
The activity of enzymes is reduced at low temperature. The temperature at which the enzymes show maximum activity is called Optimum temperature.



**Graph 6.21 Effect of temperature on enzyme activity**

#### 4. Effect of pH :

Similar to temperature, there is also pH at which an enzyme will catalyze the reaction at the maximum rate. Every enzyme has different optimum pH value. The enzyme cannot perform its function beyond the range of its pH value.



**Graph 6.22 Effect of pH on enzyme activity**

#### 5. Other Substances :

The enzymes action is also increased or decreased in the presence of some other substances such as co-enzymes, activators and inhibitors. Most of the enzymes are combination of a co-enzyme and an apo-enzyme. Activators are the inorganic substances which increase the enzyme activity. Inhibitor is the substance which retards the enzyme activity.

**Concept of Metabolism:** Metabolism is the sum of the chemical reactions that take place within each cell of a living organism and provide energy for vital processes and for synthesizing new organic material.

It involves continuous process of breakdown and synthesis of biomolecules through chemical reactions. Each of the metabolic reaction results in a transformation of biomolecules. Most of these metabolic reactions do not occur in isolation but are always linked with some other reactions.

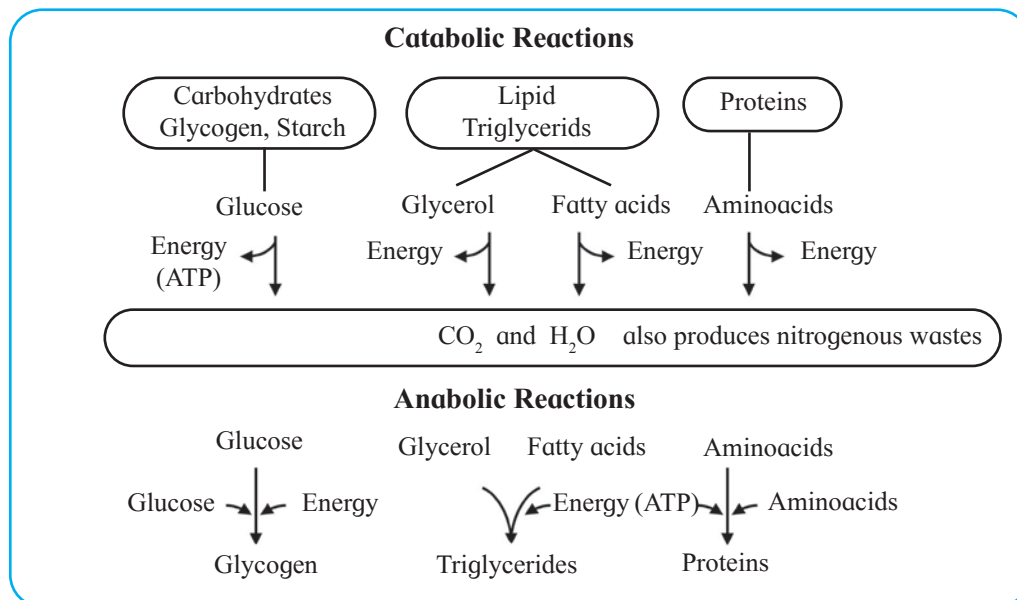
In living systems, cells are 'work centres' where metabolism involves two following types of pathways. (Fig 6.22).

**a. Catabolic pathways** lead to formation of simpler structure from a complex biomolecules e.g. when we eat wheat, bread or chapati, our gastrointestinal tract digests (hydrolyses) the starch to glucose units with help of enzymes and releases energy in form of ATP (Adenosine triphosphate).

**b. Anabolic pathway** is called biosynthetic pathway that involves formation of a more complex biomolecules from a simpler structure, e.g., synthesis of glycogen from glucose and protein from amino acids. These pathways consume energy.

**Metabolic pool :** It is the reservoir of biomolecules in the cell on which enzymes can act to produce useful products as per the need of the cell. The concept of metabolic pool is significant in cell biology because it allows one type of molecule to change into another type e.g. carbohydrates can be converted to fats and vice-versa.

Catabolic chemical reaction of glycolysis and Krebs cycle not only provide ATP but also makes available metabolic pool of biomolecules that can be utilized for synthesis of many important cellular components. The metabolites can be added or withdrawn from this pool according to the need of the cell. The balance between catabolism and anabolism maintain homeostasis in the cell as well as in the whole body.



**Fig. 6.22 Catabolic and anabolic reactions**

**Secondary metabolites (SMs) :** Secondary metabolisms are small organic molecules produced by organisms that are not essential for their growth, development and reproductions. Several types of bacteria, fungi and plants produce secondary metabolites.

Secondary metabolites can be classified on the basis of chemical structure (e.g. SMs containing rings, sugar), composition (with or without nitrogen), their solubility in various solvents, or the pathway by which they are synthesized (e.g. phenylpropanoid produces tannins). A simple way of classifying secondary metabolites includes three main groups such as,

1. **Terpenes :** Made from mevalonic acid that is composed mainly of carbon and hydrogen
2. **Phenolics :** Made from simple sugars containing benzene rings, hydrogen and oxygen.
3. **Nitrogen-containing compounds :** Extremely diverse class may also contain sulphur.

### Economic importance -

#### Secondary metabolites :

1. Secondary metabolites from natural sources have made a significant contribution for millennia. In modern medicine, drugs developed from secondary metabolites have been used to treat infectious diseases, cancer, hypertension and inflammation.
2. Morphine was the first alkaloid isolated from plant *Papaver somniferum*. It is used as pain reliever and cough suppressant.
3. SMs like alkaloids nicotine and cocaine and the terpenes cannabinal are widely used for recreation and stimulation.
4. Flavours of secondary metabolites improve our food preference.
5. Characteristic flavours and aroma of cabbage and its relatives are caused by nitrogen and sulphur-containing chemicals, glucosinolates, protect these plants from many pests.
6. Tannins are added to wines and chocolate for improving astringency.
7. Since most of secondary metabolites are having antibiotic properties, they are also used as food preservatives.



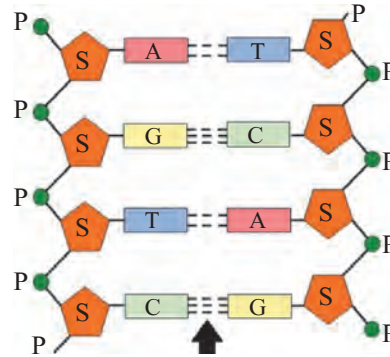
## Exercise

### 1. Choose correct option

- A. Sugar, amino acids and nucleotides unite to their respective subunits to form-----  
 a. bioelements      b. micromolecules  
 c. macromolecules    d. each of these
- B. Glycosidic bond is found in -----  
 a. Disaccharide      b. Nucleosides  
 c. Polysaccharide    d. each of these
- C. Amino acids in a polypeptide are joined by -----bond.  
 a. Disulphide      b. glycosidic  
 c. hydrogen bond    d. none of these
- D. Lipids associated with cell membrane are -----  
 a. Spingomyelin      b. Isoprenoids  
 c. Phospolipids      d. Cholesterol
- E. Linoleic, Linolenic and ----- acids are referred as essential fatty acids since they cannot be synthesized by the body and hence must be included in daily diet.  
 a. Arachidonic      b. Oleic  
 c. Stearic            d. Palmitic
- F. Haemoglobin is a type of ----- protein, which plays indispensable part in respiration.  
 a. simple              b. derived  
 c. conjugated        d. complex
- G. When inorganic ions or metallo-organic molecules bind to apoenzyme, they together form-----  
 a. isoenzyme          b. holoenzyme  
 c. denatured enzyme    d. none of these
- H. In enzyme kinetics,  $K_m = V_{max}/2$ . If  $K_m$  value is lower, it indicates -----  
 a. Enzyme has less affinity for substrate  
 b. Enzyme has higher affinity towards substrate  
 c. There will be no product formation  
 d. All active sites of enzyme are saturated.

### 2. Solve the following questions:

- A. Observe the following figure and name the type of bond shown by arrow in the structure.



### 3. Answer the following questions

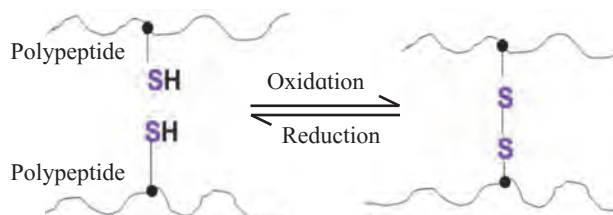
- A. What are building blocks of life?  
 B. Explain the peptide bond.  
 C. How many types of polysaccharides you know?  
 D. Enlist the significance of carbohydrates.  
 E. What is a reducing sugar?  
 F. What is the basic difference between saturated and unsaturated fatty acid?  
 G. Enlist the examples of simple proteins and give their significance.  
 H. Explain the secondary structure of protein with examples.  
 I. Explain the induced fit model for mode of enzyme action.  
 J. What is RNA? Enlist types of RNA.  
 K. Describe the concept of metabolic pool.  
 L. How do secondary metabolites are useful for mankind?

### 4. Solve the following questions:

- A. Complete the following chart.

Protein	Physiological role
Collagen	.....
.....	Responsible for muscle contraction
Immunoglobulin IgG	.....
.....	Significant in respiration
Fibrinogen	.....

B. Answer the questions with reference to the following figure.



- Name the type of bond formed between two polypeptides.
- Which amino acid is involved in the formation of such bond?
- Amongst I, II, III and IV structural levels of protein, which level of structure includes such bond?

C. Match the following items given in column I and II.

Column I	Column II
i. RNA	a. Induced fit model
ii. Yam plant	b. Flax seeds
iii. Koshland	c. Hydrolase
iv. Omega-3-fatty acid	d. Uracil
v. Sucrase	e. Anti-fertility pills

### 5. Long answer questions

- What are biomolecules? Explain the building blocks of life.
- Explain the classes of carbohydrates with examples.
- Describe the types of lipids and mention their biological significance.
- Explain the chemical nature, structure and role of phospholipids in biological membrane.
- Describe classes of proteins with their importance.
- What are enzymes? How are they classified? Mention example of each class.
- Explain the properties of enzymes.
- Describe the factors affecting enzyme action.

- What are nucleic acids? Enlist the point of differences among DNA and RNA.
- What are the types of RNA? Mention the role of each class of RNA.
- What is metabolism? How metabolic pool is formed in the cell.

6. If double stranded DNA has 14% C (cytosine) what is percentage of A (adenine), T (thymine) and G (guanine) would you expect?

### 7. Name

- The term that describes all the chemical reactions taking place in an organism.
- The form in which carbohydrate is transported in a plant.
- The reagent used for testing of reducing sugar.

### Practical / Project :

- Perform an experiment to study starch granules isolated from potato.
- Study the action of enzyme urease on urea.

## 7. Cell Division



### Can you recall?

1. How do your body wounds heal?
2. What is the difference between growth of non-living material and living organism?

Life of all multicellular organisms starts from single cell i.e. zygote. Growth of every living organism depends on cell division. As stated in the cell theory, every cell arises from the pre-existing cell.

### 7.1 Cell cycle :

Sequential events occurring in the life of a dividing cell is called **cell cycle**. There are two phases of cell cycle as interphase and M-phase. During interphase, cell undergoes growth or rest as per the need. During M-phase, the cell undergoes actual division. Interphase alternates with the period of division.

**Interphase :** Interphase is the stage between two successive cell divisions. It is the longest phase of cell cycle during which the cell is highly active and prepares itself for cell division. The interphase is divisible into three sub-phases as  $G_1$ -phase, S-phase and  $G_2$ -phase.

**$G_1$ -phase :** This is also known as first gap period or first growth period. It starts immediately after cell division. Cell performs RNA synthesis (mRNA, rRNA and t-RNA), protein synthesis and synthesis of membranes during this phase.

**S-phase :** It is synthesis phase in which DNA is synthesized or replicated, so that amount of DNA per cell doubles. Histone proteins are also synthesized during this phase.

**$G_2$  phase :**  $G_2$  is the second growth phase, during which nucleus increases in volume. Metabolic activities essential for cell division occur during this phase. Various proteins necessary for cell division are synthesized during this phase. Besides, RNA synthesis also occur during this phase. In animal cells, a daughter pair of centrioles appear near the pre-existing pair.

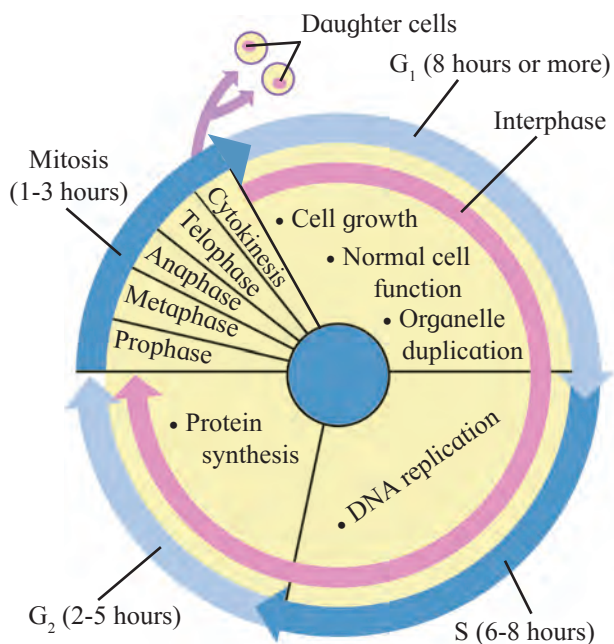


Fig. 7.1 Cell cycle



### Discuss with Teacher

Some cells do not have gap phase in their cell cycle whereas some cells spend maximum part of their life in gap phase. Search for such cells. Some cells are said to be in their  $G_0$  phase. What is this  $G_0$  phase?

**M-phase or period of division :** 'M' stands for mitosis or meiosis. M-phase involves karyokinesis and cytokinesis. Karyokinesis is the division of nucleus into two daughter nuclei whereas cytokinesis is division of cytoplasm resulting in two daughter cells.

### 7.2 Types of cell division :

Three kinds of cell division are found in animal cells. They are amitosis or direct division, mitosis or indirect division and meiosis or reductional division. Mitosis can be performed by haploid as well as diploid cells but meiosis can be performed by diploid cells only. In honey bee, drones develop from haploid unfertilized eggs whereas in *Marchantia*, haploid spores form gametophyte by mitosis.

**A. Amitosis :** It is the simplest mode of cell division. During amitosis, nucleus elongates and a constriction appears somewhere along its length. This constriction deepens and divides the nucleus unequally into two daughter nuclei. This is followed by the division of the cytoplasm which results in the formation of two daughter cells. This division occurs in unicellular organisms, abnormal cells, old cells and in foetal membrane cells.



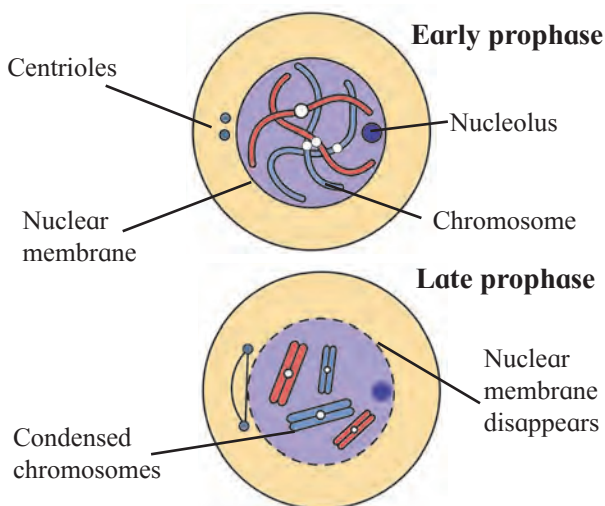
**Internet my friend**

What is Karyogram or Karyotype?

**B. Mitosis :** This is a type of cell division in which a cell divides to form two identical daughter cells which are identical to the parent cell. It is completed in two steps as karyokinesis and cytokinesis.

Karyokinesis is nuclear division which is sub-divided into prophase, metaphase, anaphase, and telephase. Although for the sake of convenience above mentioned steps are used, it must be remembered that mitosis is a continuous process that starts with the disappearance of nuclear membrane in prophase and ends with separation of two fully formed cells after cytokinesis.

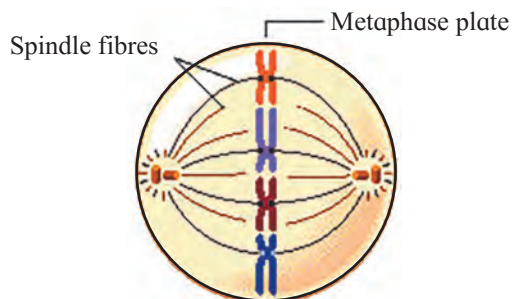
**1. Prophase :** This phase involves condensation of chromatin material, migration of centrioles, appearance of mitotic apparatus and disappearance of nuclear membrane.



**Fig. 7.2 Prophase**

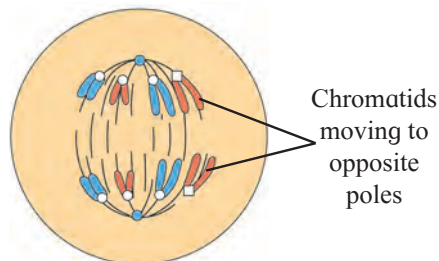
Due to condensation, each chromosome becomes visible under light microscope which can be seen with its sister-chromatids connected by centromere. The nucleolus starts to disappear. Nuclear membrane disintegrates and disappears gradually. Centrosome which had undergone duplication during interphase begins to move towards opposite poles of the cell. Mitotic apparatus is almost completely formed.

**2. Metaphase :** In this phase, chromosomes are completely condensed so that they appear very short. Sister-chromatids and centromere become very prominent. All the chromosomes lie at equatorial plane of the cell. This is called metaphase plate. Mitotic spindle is fully formed. Spindle fibres are attached to centromere. Centromere of each chromosome divides horizontally (parallel to long axis) into two, each being associated with a chromatid.



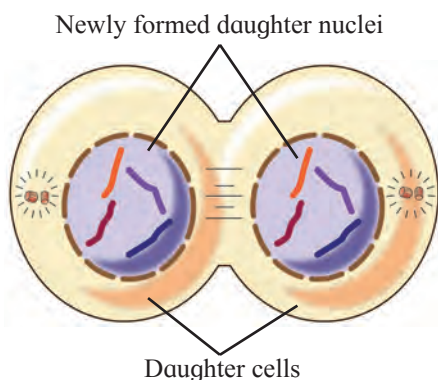
**Fig. 7.3 Metaphase**

**3. Anaphase :** The chromatids of each chromosome separate and form two chromosomes called **daughter chromosomes**. The formed chromosomes are pulled away in opposite direction by spindle apparatus. Chromosomes being pulled away appear like a bunch of banana during anaphase. Each set of chromosomes reach at opposite poles of the cells marks the end of anaphase.



**Fig. 7.4 Anaphase**

**4. Telophase :** The telophase is the final stage of karyokinesis. The chromosomes with their centromeres at the poles begin to uncoil, lengthen and lose their individuality. The nucleolus begins to reappear. The nuclear membrane begins to appear around the chromosomes. Spindle fibres break down and get absorbed in the cytoplasm. Thus two daughter nuclei are formed in a cell.



**Fig. 7.5 Telophase**

**Cytokinesis :** The division of the cytoplasm into two daughter cells is called cytokinesis. The division starts with a constriction, generally at the equator. This constriction gradually deepens and ultimately joins in the centre dividing into two daughter cells. This process of division of cytoplasm is perpendicular to the spindle. This mechanism of cytokinesis is characteristic of animal cells.

However, plant cells are covered by a relatively non-flexible cell wall. Due to this, furrow can not be formed. Instead, cell wall/partition starts to appear at the centre of the cell and grows outward to meet the existing lateral walls. The formation of the new cell wall begins with the formation of a simple precursor, called the 'cell-plate' that represents the middle lamella between the walls of two adjacent cells.

At the time of cytoplasmic division, organelles like mitochondria and plastids get distributed between the two daughter cells.

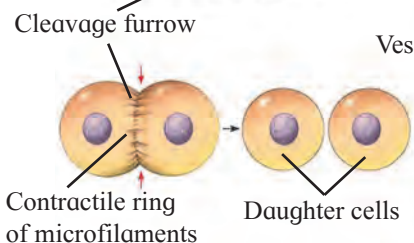
**Significance of mitosis :** As mitosis is equational division, the chromosome number is maintained constant. It ensures equal distribution of the nuclear and the cytoplasmic content between the daughter cells, both quantitatively and qualitatively. The hereditary material (DNA) is also equally distributed. It helps in the growth and development of organisms.



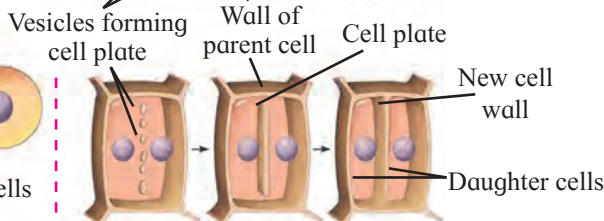
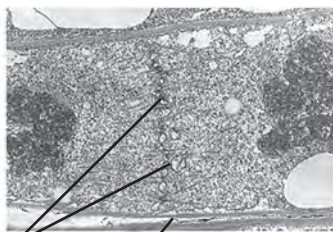
**Do you know ?**

Pulling away of daughter chromosomes is achieved by elongation and shortening of two types of spindle fibres. Spindle fibre present between centriole and centromere, called as kinetochore fibres contract and the spindle fibres present between two opposite centrioles, called as polar fibres elongate.

**Cytokinesis in animal cell**



**Cytokinesis in plant cell**



**Fig. 7.6 Cytokinesis**



Old and worn-out cells are replaced through mitosis. It helps in the asexual reproduction of organisms and vegetative propagation in plants. The process of mitosis also maintains the nucleo-cytoplasmic ratio. Mitosis is a very reliable process for preserving the genetic make-up of cells or organisms, but it cannot introduce variation or new combination of existing genes.



### Can you tell?

1. What is cell cycle?
2. Which processes occur during interphase?
3. Which are the steps of mitosis?



### Internet my friend

How the life span of a cell is decided?

**Death of cell :** You may think of it as a bad for cells in your body to die. In many cases, that's true: it's not good for cells to die because of an injury (for example, due to scrape or a harmful chemical), which is called necrosis. However, some cells of our body die; not randomly but in a carefully controlled way. For example, during the embryonic development, the cells between the embryonic fingers (digits) die naturally (by process, called apoptosis) to give a definite shape to the fingers. This is a common form of programmed cell death where cells undergo "cellular suicide" when they receive certain signals. Apoptosis involves the cell death, but it benefits the organism as a whole (for instance, by letting fingers develop or by eliminating potential cancer cells).

**C. Meiosis :** The term meiosis was coined by J. B. Farmer in 1905. It takes place only in reproductive cells during the formation of gametes. By this division, of the total number, the number of chromosomes is reduced to half, hence it is also called reductional division. The cells in which meiosis take place are termed as meiocytes. Meiosis produces four haploid daughter cells from a diploid parent cell. Meiosis is of two types of divisions :

1. **First meiotic division or Heterotypic division – (Meiosis I)**
2. **Second meiotic division or Homotypic division (Meiosis II)**

### A. First meiotic division or Heterotypic division (Meiosis I)

During 1<sup>st</sup> meiotic division, diploid cell is divided into two haploid cells. The chromosome number is reduced to half of the total number in daughter cells. Hence this division is also called heterotypic division.

It consists of the phases like prophase-I, metaphase-I, anaphase-I, telophase-I and cytokinesis-I

**Prophase-I :** This phase has longer duration. Significant features which are peculiar to meiosis occurs in this phase. This phase can be sub-divided into five sub-stages as Leptotene, Zygotene, Pachytene, Diplotene and Diakinesis.

**Leptotene :** The volume of nucleus increases. The chromosomes become distinct, long thread-like and coiled. They take up a specific orientation- the 'bouquet stage' inside the nucleus. This is characterised with the ends of chromosomes converged towards that side of the nucleus where the centrosome lies. The centrosome duplicates and migrate to opposite poles.

**Zygotene :** Intimate pairing of homologous chromosomes takes place by formation of synaptonemal complex. This pairing is called synapsis. Each pair consists of a maternal chromosome and a paternal chromosome.

**Pachytene :** Each individual homologue (chromosome) has two similar chromatids. At this stage, tetrads (tetra-valents) become more clear in appearance because of presence of four visible chromatids. The homologous chromosomes of each pair begin to separate from each other. However, they do not completely separate but remain attached together at one or more points.

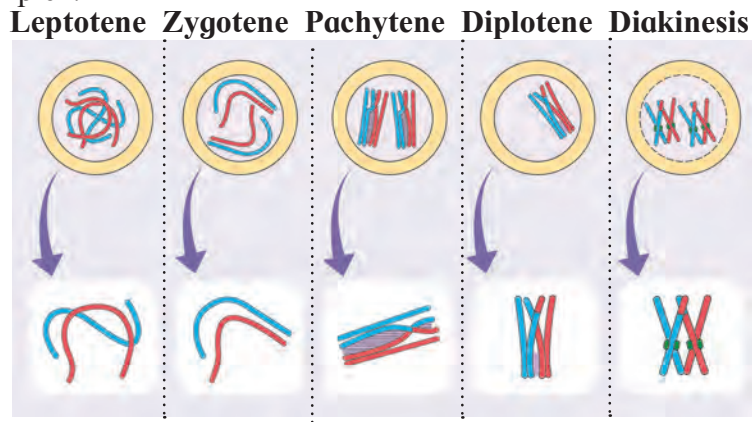
These points appear like a cross (X) known as chiasmata. Chromatids break at these points and broken segments are wrongly exchanged between non-sister chromatids of homologous chromosomes. This is called as crossing-over or recombination.

**Diplotene :** Though chiasmata are formed in pachytene, they become clearly visible in diplotene due to the beginning of repulsion between synapsed homologous chromosomes. This is called desynapsis. It involves disappearance of synaptonemal complex.

**Diakinesis :** In this phase, the chiasmata begins to move along the length of chromosomes from the centromere towards the ends of chromosomes. The displacement of chiasmata is termed as terminalization. The terminal chiasmata exist till the metaphase.

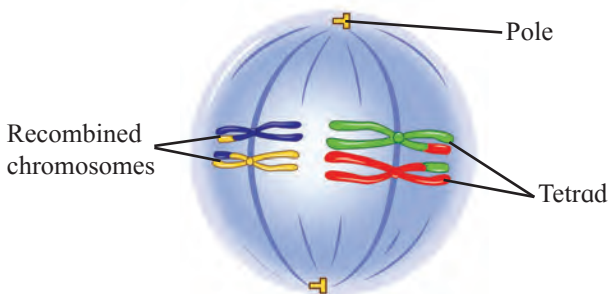
The nucleolus disappears and the nuclear membrane also begins to disappear. Spindle fibres starts to appear in the cytoplasm.

**Do yourself**  
Write down the explanation of prophase I in your words.



**Fig. 7.7 Prophase I**

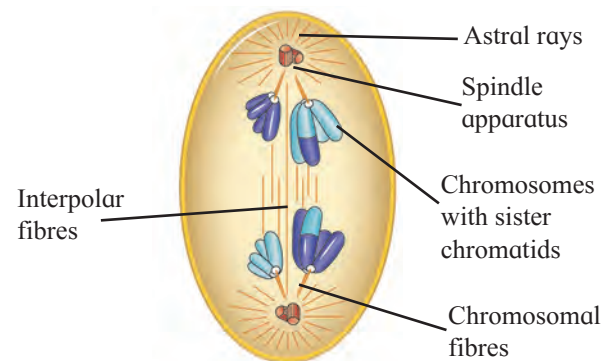
**Metaphase-I :** The spindle fibres become well developed. The tetrads move towards the equator and they orient themselves on the equator in such a way that centromeres of homologous tetrads lie towards the poles and arms towards the equator. Due to increasing repulsive forces between homologous chromosomes, they are ready to separate from each other.



**Fig. 7.8 Metaphase-I**

**Anaphase-I :** In this phase, homologous chromosomes are pulled away from each other and carried towards opposite poles by spindle apparatus. This is disjunction. The two sister chromatids of each chromosome do not separate in meiosis-I.

This is reductional division. The sister chromatids of each chromosome are connected by a common centromere. Both sister chromatids of each chromosome are now different in terms of genetic content as one of them has undergone the recombination.

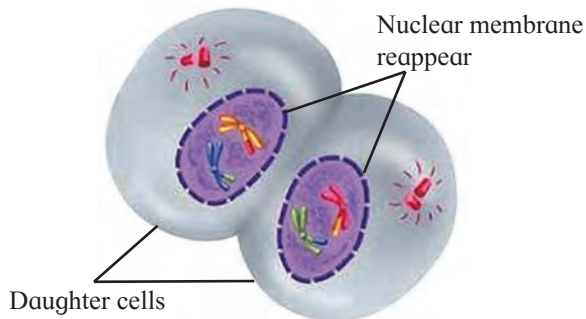


**Fig. 7.9 Anaphase-I**

**Telophase-I :** The haploid number of chromosomes after reaching their respective poles, become uncoiled and elongated. The nuclear membrane and the nucleolus reappear and thus two daughter nuclei are formed.

**Cytokinesis-I** : After the karyokinesis, cytokinesis occurs and two haploid cells are formed.

In many cases, these daughter cells pass through a short resting phase or interphase / interkinesis. In some cases, the changes of the telophase may not occur. The anaphase I directly leads to the prophase of meiosis II.



**Fig. 7.10 Cytokinesis-I**

### B. Second meiotic division or Homotypic Division (Meiosis II)

During this division, two haploid cells formed during first meiotic division divide further into four haploid cells. This division is similar to mitosis. The daughter cells formed in second meiotic division are identical to their parent cells with respect to the chromosome number formed in meiosis-I. Hence this division is called homotypic division.

It consists of the following phases : prophase-II, metaphase-II, anaphase-II, telophase-II and cytokinesis-II.

**Prophase-II** : The chromosomes are distinct with two chromatids. Each centriole divides into two resulting in the formation of two centrioles which migrate to opposite poles and form asters. Spindle fibres are formed between the centrioles. The nuclear membrane and nucleolus disappear.

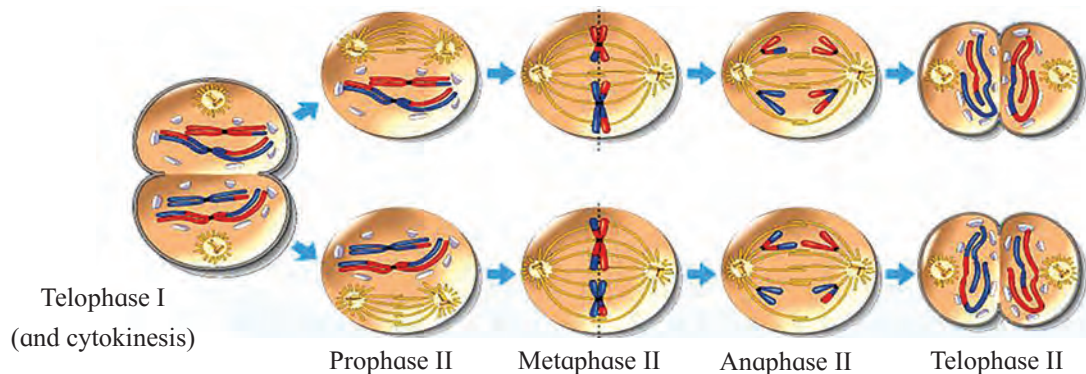
**Metaphase-II** : Chromosomes gets arranged at the equator. The two chromatids of each chromosome are separated by the division of the centromere. Some spindle fibres are attached to the centromeres and some are arranged end to end between two opposite centrioles.

**Anaphase-II** : The separated chromatids become daughter chromosomes and move to opposite poles due to the contraction of the spindle fibres attached to centromeres.

**Telophase-II** : During this stage the daughter chromosomes uncoil. The nuclear membrane surrounds each group of chromosomes and the nucleolus reappears.

#### Curiosity box:

1. What is exact structure of synaptonemal complex?
2. What is structure of chiasma?
3. Which type of proteins are involved in formation of spindle fibres?
4. Why and how some spindle fibres elongate and some contract?
5. What is the role of centrioles in formation of spindle apparatus?
6. What would have happened in absence of meiosis?



**Fig. 7.11 Meiosis II**

**Cytokinesis-II** : Cytokinesis occurs after nuclear division. Two haploid cells are formed from each haploid cell. Thus, in all, four haploid daughter cells are formed. These cells undergo further changes to develop into gametes.

**Significance of Meiosis** : Meiotic division produces gametes or spores. If meiosis does not operate then the number of chromosome would double or quadruple resulting in the formation of monstrosities (abnormal forms). The constant number of chromosomes in a given species across generations is maintained by meiosis and fertilization. Because of crossing over, exchange of genetic material takes place leading to genetic variations, which are the raw materials for evolution.



#### Internet my friend

Different types of proteins like cyclins, maturation promoting factor (MPF), cyclosomes, enzymes like cyclin dependent kinases (CDK) play important role in control of cell cycle. Collect more information about these proteins and enzymes from internet, prepare a power-point presentation and present it in the class.



#### Can you tell?

1. What is difference between mitosis and meiosis?
2. What is difference between meiosis-I and meiosis-II?
3. Elaborate the process of recombination.

#### Do Yourself

Prepare a concept map on cell division -mitosis/ meiosis in following box.



## Exercise

### 1. Choose correct option

- A. The connecting link between Meiosis-I and Meiosis-II is .....
- a. interphase-I    b. interphase-II  
c. interkinesis    d. anaphase-I
- B. Synapsis is pairing of .....
- a. any two chromosomes  
b. non-homologous chromosomes  
c. sister chromatids  
d. homologous chromosomes
- C. Spindle apparatus is formed during which stage of mitosis?
- a. Prophase.    b. Metaphase.  
c. Anaphase.    d. Telophase.
- D. Chromosome number of a cell is almost doubled up during .....
- a.  $G_1$ -phase    b. S-phase  
c.  $G_2$ -phase    d.  $G_0$ -phase
- E. How many meiotic divisions are necessary for formation of 80 sperms?
- a. 80    b. 40    c. 20    d. 10
- F. How many chromatids are present in anaphase-I of meiosis-I of a diploid cell having 20 chromosomes?
- a. 4    b. 6    c. 20    d. 40
- G. In which of the following phase of mitosis chromosomes are arranged at equatorial plane?
- a. Prophase    b. Metaphase  
c. Anaphase    d. Telophase
- H. Find incorrect statement -
- a. Condensation of chromatin material occurs in prophase.  
b. Daughter chromatids are formed in anaphase.  
c. Daughter nuclei are formed at metaphase.  
d. Nuclear membrane reappears in telophase.

- I. Histone proteins are synthesized during .....
- a.  $G_1$  phase    b. S-phase  
c.  $G_2$  phase    d. Interphase

### 2. Answer the following questions

- A. While observing a slide, student observed many cells with nuclei. But some of the nuclei were bigger as compared to others but their nuclear membrane was not so clear. Teacher inferred it as one of the phase in the cell division. Which phase may be inferred by teacher?
- B. Students prepared a slide of onion root tip. There were many cells seen under microscope. There was a cell with two groups of chromosomes at opposite ends of the cell. This cell is in which phase of mitosis?
- C. Students were shown some slides of cancerous cells. Teacher made a comment as if there would have been a control at one of its cell cycle phase, there wouldn't have been a condition like this. Which phase the teacher was referring to?
- D. Some Mendelian hybridization experimental results were shown to the students. Teacher informed that there are two genes located on the same chromosome. He enquired if they will be ever separated from each other?
- E. Students were observing a film on *Paramecium*. It underwent a process of reproduction. Teacher said it is due to cell division. But students objected and said that there was no disappearance of nuclear membrane and no spindle formation, how can it be cell division? Can you clarify?

- F. Is the meiosis responsible for evolution? Justify your answer.
- G. Why mitosis and meiosis-II are called as homotypic division?
- H. Write the significance of mitosis.
- I. Enlist the different stages of prophase-I.

**3. Draw labelled diagrams and write explanation -**

- A. With the help of suitable diagram, describe the cell cycle.
- B. Distinguish between mitosis and meiosis.
- C. Draw the diagram of metaphase.

**4. Match the following column-A with column-B and rewrite.**

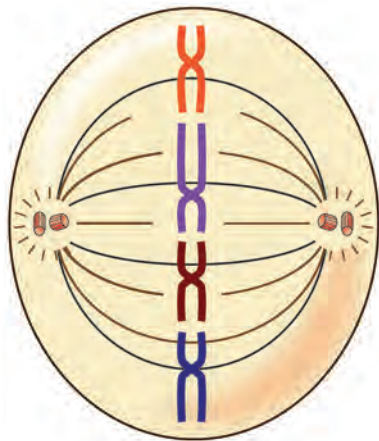
**Column-A**  
(phases)

- a. Leptotene
- b. Zygotene
- c. Pachytene
- d. Diplotene

**Column-B**  
(Their events)

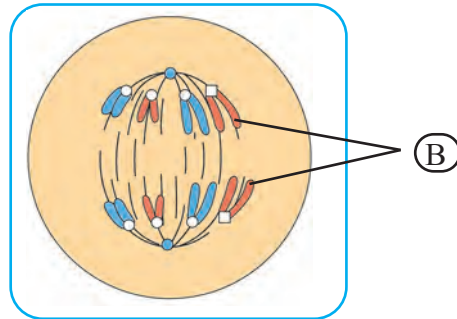
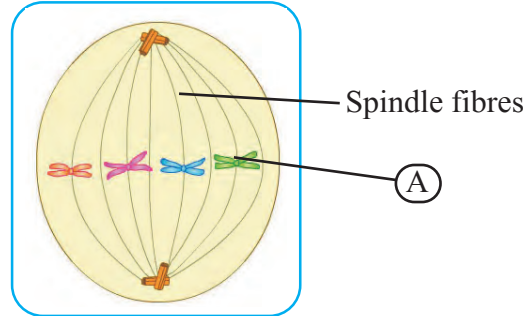
- 1. Crossing over
- 2. Desynapsis
- 3. Synapsis
- 4. Bouquet stage

**5. Is a given figure correct? why?**



**6. If an onion has 16 chromosomes in its leaf cell, how many chromosomes will be there in its root cell and pollen grain.**

**7. Identify the following phases of mitosis and label the 'A' and 'B' given in diagrams**



**Practical / Project :**

Fix the onion root tips at different durations of the day starting from 6am up to 9am at the intervals of half an hour. Prepare the slide of each fixed root tip and analyse the relation between time and phase of mitosis.

## 8. Plant Tissues and Anatomy



### Can you recall?

1. Which component bring about important processes in the living organisms?
2. What is tissue?
3. Explain simple and complex tissue.
4. Complete the flow chart.

**Organisms** → **organs** → **Cells**

### 8.1 Tissue :

Anatomy is the study of internal structure of organism. Organs are made up of group of cells. A group of similar or dissimilar cells having essentially a common function and origin is called as **tissue**. Plant tissues are grouped as meristematic tissue and permanent tissue on the basis of its ability to divide.

### 8.2 Meristematic Tissue :

It is a group of young cells. These are living cells with ability to divide in the regions where they are present. These are polyhedral or isodiametric in shape without intercellular spaces. Cell wall is thin, elastic, mainly composed of cellulose. Protoplasm is dense with distinct nucleus at the center and vacuoles if present, are very small. Cells show high rate of metabolism. These cells are immature.

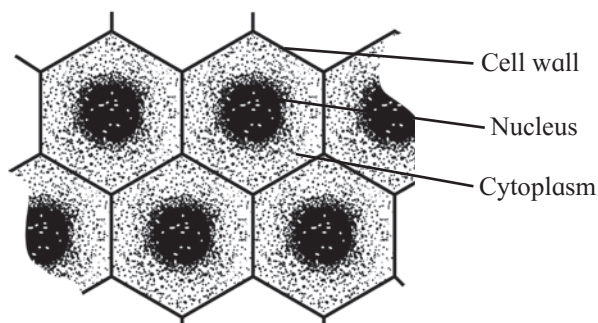


Fig. 8.1 Meristematic cells

**A. Classification of Meristem :** Following criteria are used for classification of meristems viz. origin, function and position as follows-

### 1. Origin :

**Primordial meristem or promeristem** is also called as embryonic meristem. Usually occupying very minute area at the tip of root and shoot. **Primary meristem** originates from the primordial meristem and occurs in the plant body from the beginning, at the root and shoot apices. Cells are dividing and different permanent tissues are produced from primary meristems. **Secondary meristematic** tissues develop from living permanent tissues during later stages of plant growth; hence are called as secondary meristems. This tissue occurs in the mature regions of root and shoot of many plants. Secondary meristem is always lateral (to the central axis) in position e.g. fascicular cambium, inter fascicular cambium, cork cambium.

**2. Position :** **Apical meristem** is produced from promeristem and forms growing point of apices of root, shoot and their lateral branches. It brings about increase in length of plant body and called as apical initials. Shoot apical meristem is terminal in position whereas in root it is subterminal i.e. located behind the root cap. **Intercalary meristematic** tissue is present in the top or base area of node. Their activity is mainly seen in monocots. These are short lived.

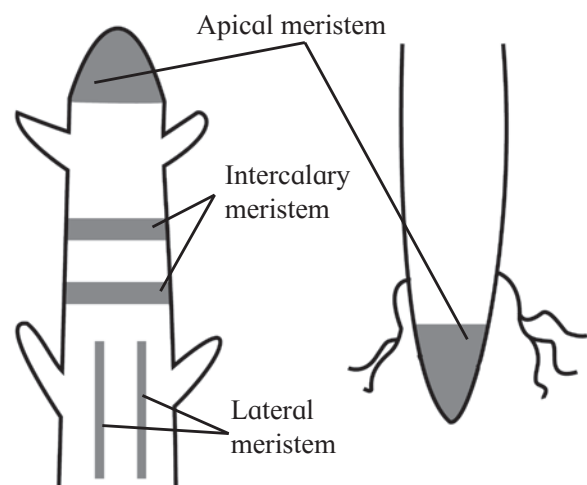


Fig. 8.2 Location of meristematic tissue

**Lateral meristem** is present along the sides of central axis of organs. It takes part in increasing girth of stem or root. eg. intrafascicular cambium. It is found in vascular bundles of gymnosperms and dicot angiosperms.

**3. Function :** Young growing region of the plant has **Protoderm** that forms protective covering like epidermis around the various organs. Meristem called **Procambium** is involved in developing primary vascular tissue while the other structures like cortex, endodermis, pericycle, medullary rays, pith are formed from the region of **Ground meristem**. These are the three groups of meristem based on function.



### Can you tell?

1. Enlist the characteristics of meristematic tissue.
2. Classify meristematic tissue on the basis of origin.

## 8.3 Permanent tissue :

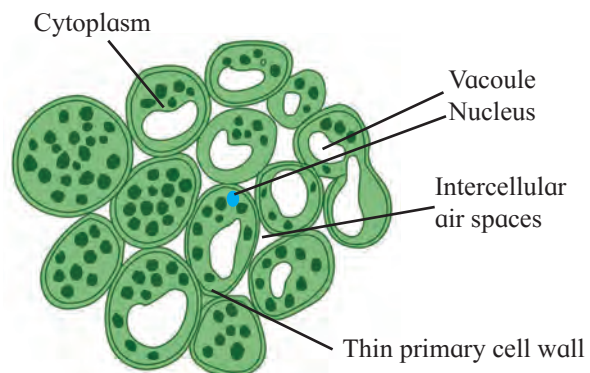
This is group of cells which have lost the capacity of division and acquired permanent size, shape and functions. It is due to different morphological, physiological and functional changes that occur during maturation of the cell. Depending upon types of cells, there are two types as simple and complex permanent tissues.

### A. Simple permanent tissues :

These are made up of only one type of cells carrying similar functions. This tissue is either living or dead. Following are the types of simple permanent tissues namely, **Parenchyma**, **Collenchyma** and **Sclerenchyma**.

**1. Parenchyma :** Cells in this tissue are thin walled, isodiametric, round, oval to polygonal or elongated in shape. Cell wall is composed of cellulose. Cells are living with prominent nucleus and cytoplasm with large vacuole. This is less specialized permanent tissue.

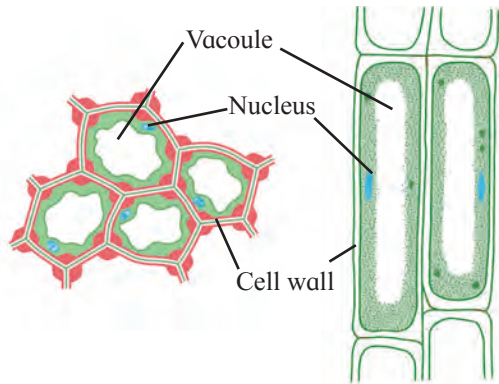
Parenchyma has distinct intercellular spaces. Sometimes, cells may show compact arrangement. The cytoplasm of adjacent cells is interconnected through plasmodesmata and thus forms a continuous tissue. These cells are distributed in all the parts of plant body viz. epidermis, cortex, pericycle, pith, mesophyll cells, endosperm, xylem and phloem. These cells store food, water, help in gaseous exchange, increase buoyancy, perform photosynthesis and different functions in plant body. Dedifferentiation in parenchyma cells develops vascular cambium and cork cambium at the time of secondary growth.



**Fig. 8.3 Simple permanent tissue**

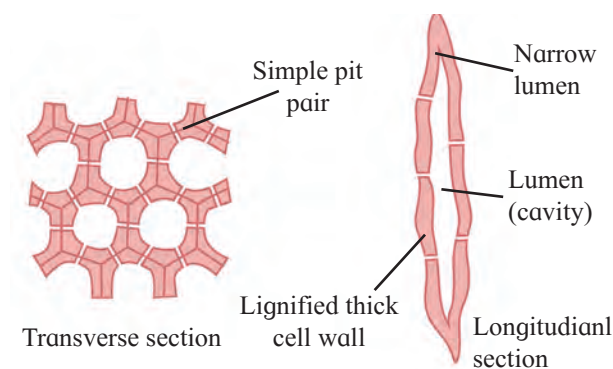
**2. Collenchyma :** It is a simple permanent tissue made up of living cells. The cell wall is cellulosic but shows uneven deposition of cellulose and pectin especially at corners. The walls may show presence of pits. Cells are similar like parenchyma containing cytoplasm, nucleus and vacuoles but small in size and without intercellular gaps. Thus appears to be compactly packed. The cells are either circular, oval or angular in transverse section. Collenchyma is living mechanical tissue and serves different functions in plants. It gives mechanical strength to young stem and parts like petiole of leaf. It allows bending and pulling action in plant parts and also prevents tearing of leaf. Growth of organs and elongation are other functions. Collenchyma is usually absent in monocots and roots of dicot plant.





**Fig. 8.4 Collenchyma**

**3. Sclerenchyma :** It is simple permanent tissue made up of compactly arranged thick walled dead cells. The cells are living at the time of production but at maturity they become dead. As cells are devoid of cytoplasm their thickened walls are due to uniform deposition of lignin. Cells remain interconnected through several pits. It is of two types viz. fibres and sclereids. Fibres are thread-like, elongated and narrow structures with tapering and interlocking end walls. These are mostly in bundles, pits are narrow, unbranched and oblique. They provide mechanical strength. Sclereids are usually broad, with blunt end walls. These occur singly or in loose groups and their pits are deep branched and straight. These are developed due to secondary thickening of parenchyma cells and provide stiffness only.

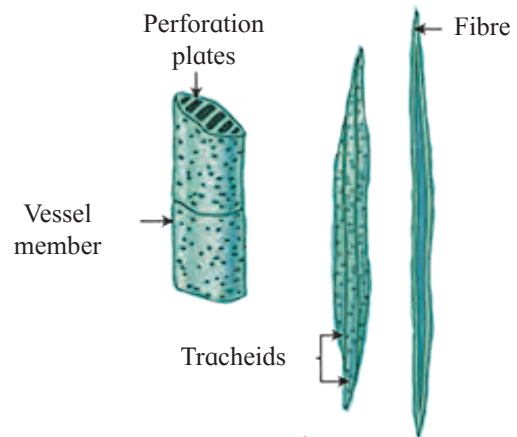


**Fig. 8.5 Sclerenchyma**

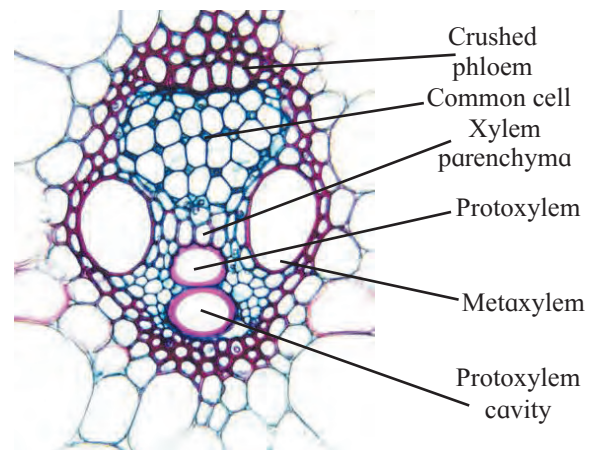
This tissue functions as the main mechanical tissue. It permits bending, shearing and pulling. It gives rigidity to leaves and prevents it from falling. It also gives rigidity to epicarps and seeds. Commercial fibres are also produced from sclerenchyma fibres. e.g. jute, flax, hemp.

**B. Complex permanent tissues :** These tissue are heterogenous comprising of more than one type of cells and all function as a single unit. This tissue is involved in conducting the sap and food from source to sink area. Xylem and phloem are the complex tissues present in plants.

**1. Xylem :** It is a dead complex tissue. Components of xylem are tracheids, vessels, xylem parenchyma and xylem fibres.



**a. Xylem tissue**



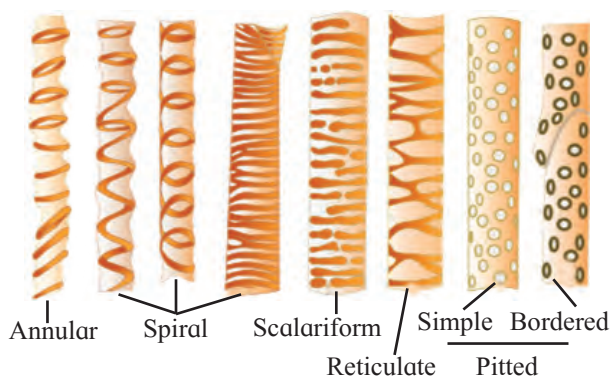
**b. Vascular bundle**

**Fig. 8.6 Xylem tissue and Vascular bundle**

The xylem also provides mechanical strength to the plant body. Tracheids and vessels conduct water and minerals. These are also known as hadrome. In pteridophytes and gymnosperms tracheids are the conducting elements while vessels in angiosperms, *Selaginella* (Pteridophyte) and *Gnetum* (Gymnosperm) are the conducting elements.

**Tracheids** are elongated, tubular and dead cells. The ends are oblique and tapering. The cell walls are thick having uneven deposition of lignin. This provides mechanical strength. Tracheids contribute 95% of wood in Gymnosperms and 5% in Angiosperms. The different types of thickening patterns are seen on their walls such as *annular* (in the form of rings), *spiral* (in the form of spring/helix), *scalariform* (ladder like), *pitted* is most advanced type (small circular area) which may be simple or bordered.

**Vessels** are longer than tracheids and are formed by dissolution of end walls of row of cells i.e. vessel elements. These are involved in conduction of water and minerals. Their lumen is wider than that of tracheids and the thickening is due to uneven deposition of lignin and similar to tracheids. In monocots, vessels are rounded where as they are angular in dicot angiosperms. The first formed xylem vessels (protoxylem) are small and have either annular or spiral thickenings while later formed larger vessels (metaxylem) have reticulate or pitted thickenings. When protoxylem is arranged towards pith and metaxylem towards periphery, it is called as *endarch* e.g. in stem and when the position is reverse as in the roots is called as *exarch*.

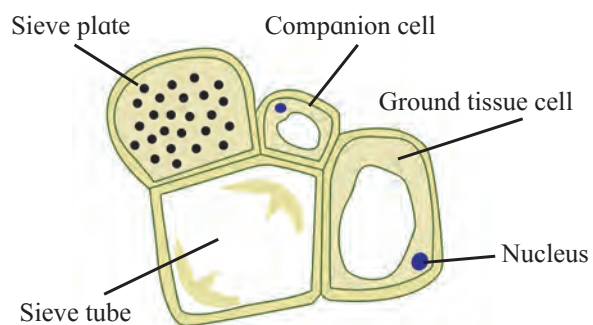


**Fig. 8.7 Tracheids**

**Xylem parenchyma** cells are small associated with tracheids and vessels. This is the only living tissue among this complex tissue. The function is to store food (starch) and sometimes tannins. Parenchyma are involved in lateral or radial conduction of water or sap.

**Xylem fibres** are sclerenchymatous cells and serve mainly mechanical support. These are called wood fibres. These are also elongated, narrow and spindle shaped. Cells are tapering at both the ends and their walls are lignified.

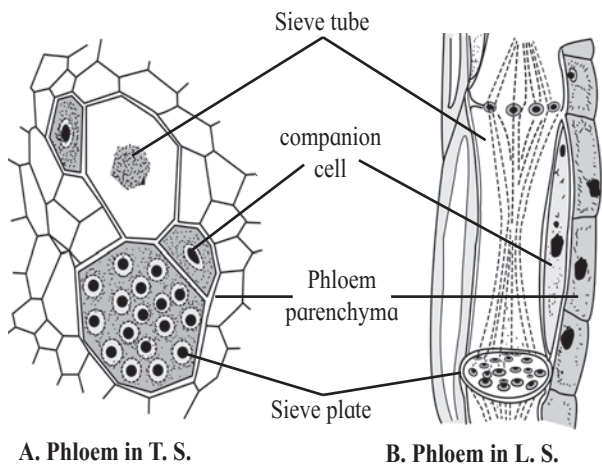
**Phloem** : This is a living tissue. It is also called as bast. Phloem is responsible for conduction of organic food material from source (leaf generally) to a sink (other plant parts). Phloem was named as leptome by Haberlandt as similar to xylem. On the basis of origin, it is proto (first formed) and meta (later formed) phloem. It is composed of sieve cells, sieve tubes, companion cells, phloem parenchyma and phloem fibres.



**Fig. 8.8 Phloem**

**Sieve tubes** are long tubular conducting channel of phloem. These are placed end to end with bulging at end walls. The sieve tube has sieve plate formed by septa having small pores. The sieve plates connect protoplast of adjacent sieve tube cells. The sieve tube cell is a living cell with a thin layer of cytoplasm but loses its nucleus at maturity. The sieve tube cell is connected to companion cell through phloem parenchyma by plasmodesmata. *Sieve cells* are found in lower plants like pteridophytes and gymnosperms. The cells are narrow, elongated with tapering ends and sieve area located laterally.

**Companion cells** are narrow elongated and living. These cells are laterally associated with sieve tube elements. Companion cells have dense cytoplasm and prominent nucleus.



**Fig. 8.9 Phloem tissue**

Nucleus of companion cell regulates functions of sieve tube cells through simple pits. From origin point of view, sieve tube cells and companion cell are derived from same cell. Death of the one results in death of the other type.

**Phloem parenchyma** cells are living, elongated found associated with sieve tube and companion cells. The chief function is to store food, latex, resins, mucilage, etc. The cells carry out lateral conduction of food material. It is absent in most of the monocots.

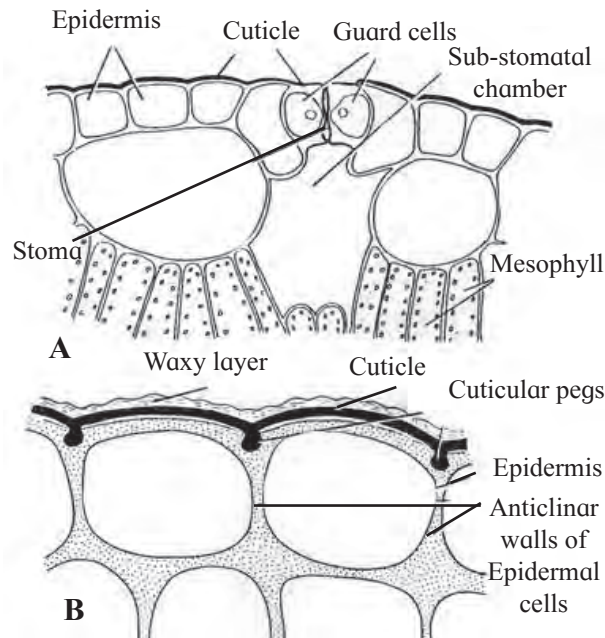
**Phloem fibres** are the only dead tissue among this unit. These are sclerenchymatous. Generally absent in primary phloem, but present in secondary phloem. These cells are with lignified walls and provide mechanical support. These are used in making ropes and rough clothes.



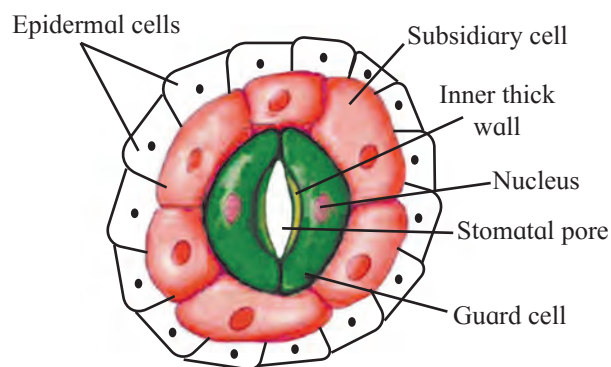
**Can you tell?**

1. Write a note on parenchyma.
2. Describe schlerenchyma fibres.
3. Sketch and label T.S. of phloem tissue.

**8.4 Tissue Systems :** Plant tissues are derived from meristems and their structure and functions depend on the position. On the basis of their structure and location, three types of tissue systems are present viz. Epidermal tissue system, ground tissue system and vascular tissue system.



**Fig. 8.10 Epidermal tissue system**



**Fig. 8.11 Epidermal cells**

**A. Epidermal tissue system :** It forms the outer covering of plant body and is derived from protoderm or dermatogen. The two types of structures are seen in epidermal tissue system viz epidermis and epidermal appendages.

**Epidermis** is the outermost protective cell layer made up of compactly arranged cells without intercellular spaces. Cells show presence of central large vacuole, thin cytoplasm and a nucleus. The outer side of the epidermis is often covered with a waxy thick layer called the cuticle which prevents the loss of water. It may bear hairs. Root epidermis has root hairs. These are unicellular elongated and involved in absorption of sap from the soil. In stem, epidermal hairs are called trichomes.

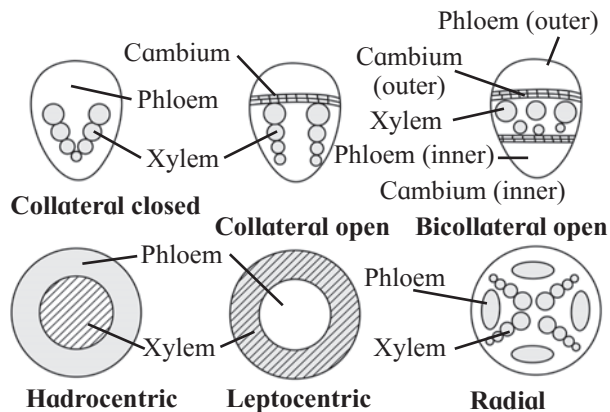
These are generally multicellular, branched or unbranched, stiff or soft or even secretory. These help in preventing water loss due to transpiration.

Small gateways in the epidermal cells are called as stoma. Such stoma are controlled or guarded by specially modified cells called guard cells. These guard cells may be kidney shaped (dicot) or dumbbell shaped (monocot), collectively called as **Stomata**. Stoma, guard cells and subsidiary cells form a unit called stomatal apparatus. Stomata are further covered by subsidiary cells. Guard cells have few chloroplasts to carry out photosynthesis. Guard cells change their turgor pressure causing opening and closing of stoma, thus they play a vital role in exchange of gases and water vapour.

**B. Ground tissue system :** All the plant tissues excluding epidermal and vascular tissues is ground tissue. It is made up of simple permanent tissue e.g. paranchyma. It is present in cortex, pericycle, pith and medullary rays in the primary stem and root. Collenchyma and sclerenchyma in the hypodermis and chloroplasts containing mesophyll tissue in leaves also constitute ground tissue.

**Vascular tissue system :** These are the distinct patches of the complex tissue viz. Xylem and phloem. On the basis of their arrangement in the plant body these are *radial* when both the complex tissue are situated separately on separate radii as separate bundle. This is a common feature of roots. In the stem, the complex tissue is collectively present as neighbours of each other on the same radius in the form where xylem is inside and phloem is outside hence called *conjoint, collateral, vascular bundles*.

These bundles may be further of **open** type (secondary growth takes place) containing cambium in between them and **closed** type if cambium is not present (secondary growth absent). When phloem is present in a vascular bundle on both the sides of xylem and intervening cambium tissue, it is called *bicollateral vascular bundle*.



**Fig. 8.12 Vascular bundles**

It is a feature of family Cucurbitaceae. When one vascular tissue is completely encircling the other, it is called as *concentric vascular bundle*, this may be leptocentric (phloem encircled by xylem) or hadrocentric (xylem encircled by phloem). When one complex tissue is encircling on both the faces of the other it is amphicribal (xylem encircled by phloem on both faces) and amphivasal (phloem encircled by xylem on both faces).

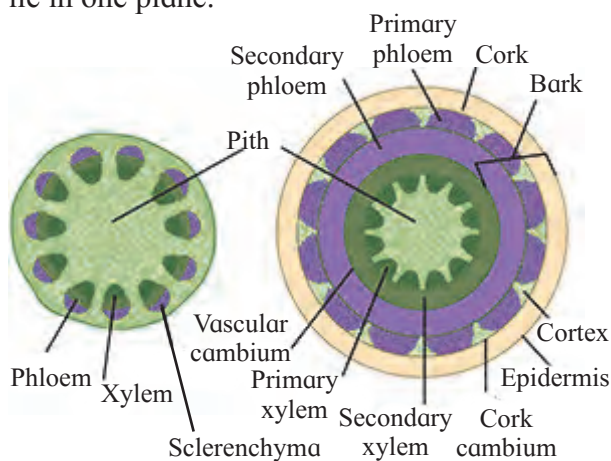
### 8.5 Secondary growth in plants :

The vertical growth of the roots and stems in length with the help of apical meristem is called as primary growth. Dicotyledonous plants and gymnosperms exhibit increase in girth of root and stem. In dicot stem, secondary growth begins with the formation of a continuous cambium ring. The cambium present between the primary xylem and primary phloem of a vascular bundle is called *intrafascicular* cambium. The cells of medullary rays adjoining these intrafascicular cambium strips become meristematic (regain the capacity to divide) and form the *interfascicular* cambium. Thus a complete and continuous ring of vascular cambium is formed.

The cambium ring cuts off new cells, towards both the sides, inner and outer. The cells that are cut-off towards pith (inner side) mature into secondary xylem and cells that are cut-off towards periphery mature into secondary phloem. Generally, amount of secondary xylem is more than the secondary phloem.

In woody plants, secondary tissues constitute the bulk of the body. This provides support, conduction of water and minerals and protection. Lateral meristems play a major role in development of secondary tissues.

**Formation of cambial ring :** With the onset of favourable season, meristematic cells of intrafascicular cambium become active. Simultaneously, the ray parenchyma cells, both fusiform initials and ray initials become meristematic. This is known as *dedifferentiation*. These form patch of cambial cells (meristematic cells) in between the adjacent bundles and produce interfascicular cambium. Now both intrafascicular and interfascicular cambium join and form a complete ring. This is known as cambial ring. This is possible because they lie in one plane.



**Fig. 8.13 Secondary growth in Dicot stem**

**Secondary growth in roots :** It is also observed in most of the dicot and gymnospermic roots by producing secondary vascular tissue and periderm. Secondary growth is produced by vascular cambium and cork cambium respectively.

Conjunctive parenchyma cells present on the inner edges of primary phloem bundles become meristematic. These cells add secondary xylem and secondary phloem on the inner and outer side respectively. These events are similar to secondary growth in stems.

## 8.6 Wood :

During favourable conditions, *spring wood* (early wood) is formed which has broader xylem bands, lighter colour, tracheids with thin wall and wide lumen, fibres are less in number, low density. Whereas, during unfavourable season *autumn wood* (late wood) is formed which has narrow xylem band, darker in colour, lumen is narrow and walls are thick with abundant fibres are present of high density. Tracheary elements of heartwood are plugged by in-growth of adjacent parenchyma cells i.e. tyloses. They are filled by oils, gums, resins, tannins called as extractives. Thus inner non-functional, durable part which is resistant to pathogens is called duramen or heartwood. Outer light, functional part of secondary xylem, cells are living, no deposition, lighter and less durable, more susceptible to pathogens and involved in conduction of sap is called as *sap wood* (alburnum).

## 8.7 Cork cambium and secondary growth:

Increase in diameter of stem by secondary growth is mainly due to the activity of vascular cambium present in the outer cortical layer. When epidermis gets ruptured, it becomes necessary to replace these cells by new cells. Phellogen (cork cambium) develops in extrastelar region of stem. The outer cortical cells of cortex become meristematic and produce a layer of thin walled, rectangular cells. These cells cut off new cells on both sides. The cells produced on outer side develop phellem (cork) where as on the inner side produce phelloderm (secondary cortex). The cork is impervious in nature and does not allow entry of water due to suberized walls.

Secondary cortex is parenchymatous in nature. Phellogen, phellem and phelloderm constitute periderm. Activity of cork cambium develops a pressure on the other cells and these cells die. Bark is non-technical term referring to all cell types found external to vascular cambium including secondary phloem. Bark of early season is soft and of the late season is hard.

Lenticles are aerating pores present (as raised scars) on the surface of bark. These are portions of periderm, where phellogen activity is more, lenticles are means for gaseous and water vapour exchange.

Monocot stems lack cambium hence secondary growth does not take place. But accessory cambium development in plants like, *Dracena*, *Agave*, Palms and root of sweet potato show presence of secondary growth. This is called as anomalous secondary growth.



### Can you tell?

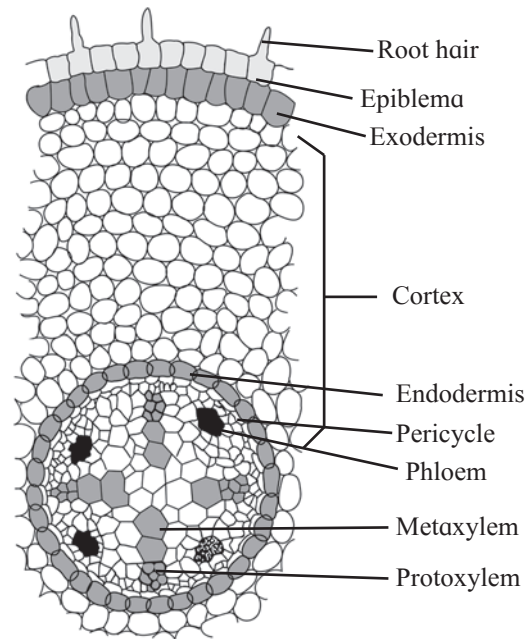
1. Concentric vascular bundles are always closed. Describe.
2. How is the arrangement of vascular bundles in dicot and monocot stem?
3. How is the structure of vascular bundles of the root?
4. Why vascular bundles of dicot stem are described as conjoint collateral and open?

## 8.8 Anatomy of Root, Stem and Leaf :

### A. Anatomy of Dicot Root :

The transverse section of a typical dicotyledonous root shows following anatomical features. The outermost single layer of cells without cuticle is **Epiblema**. Some of its cells are prolonged into unicellular root hair. Next to it on inner side is the **Cortex** which consists of several layers of typical parenchymatous cells. After the death of epiblema, outer layer of cortex become cutinized and is called **Exodermis**. The cortical cells store food and water. The innermost layer of cortex is called **Endodermis**. The cells are barrel-shaped and their radial walls bear Casparian strip or Casparian bands composed of suberin. Near the protoxylem, there are unthickened passage cells. A single layer of parenchymatous **Pericycle** is present just below endodermis which bounds the stele or vascular cylinder. **Stele** consists of 2 to 6 radial vascular bundles. Xylem is exarch. Based on the number of groups of xylem and phloem, the stele may be diarch to hexarch.

A parenchymatous connective tissue or conjunction tissue is present between xylem and phloem.

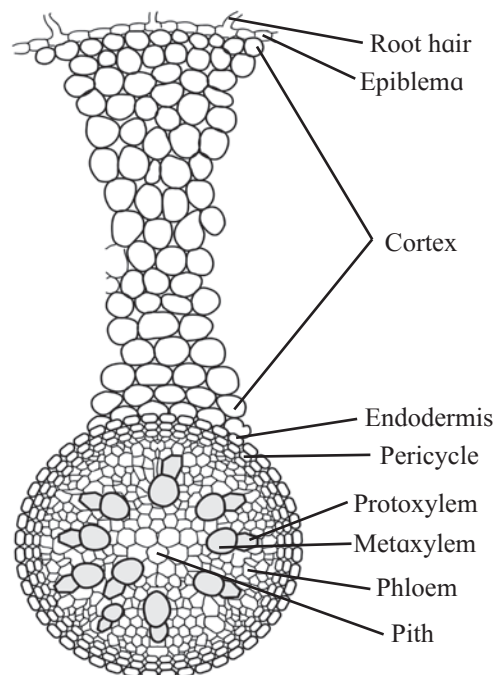


**Fig. 8.14 T. S. of dicot root**

The central part of stele or vascular cylinder is called **Pith**. It is narrow and made up of parenchymatous cells, with or without intercellular spaces. At later stage, a cambium ring develops between xylem and phloem which causes secondary growth in thickness.

### B. Anatomy of monocot root :

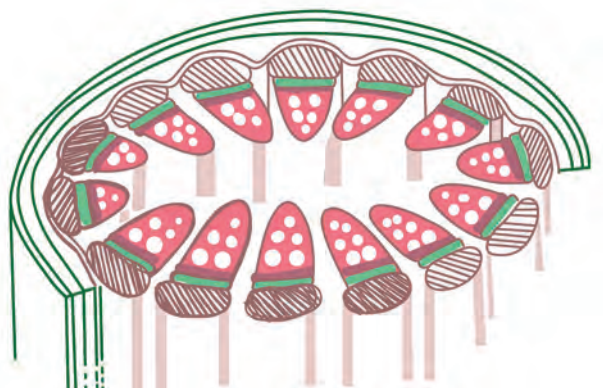
It resembles that of a dicot root in its basic plan. However, it possesses more than six xylem bundles (polyarch condition). Pith is large and well-developed. Secondary growth is absent.



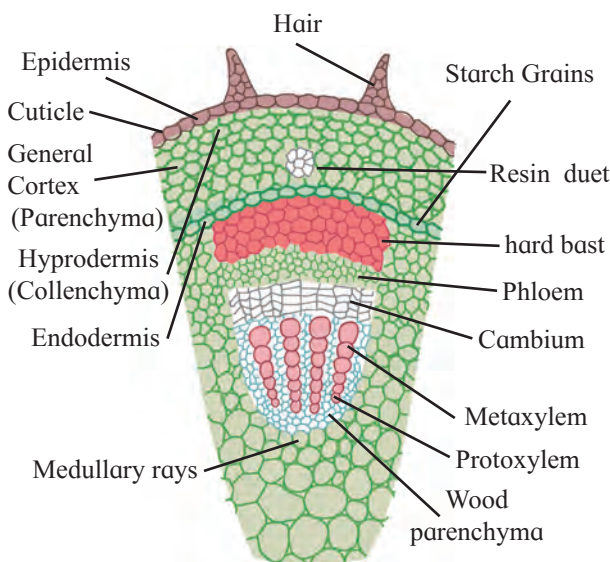
**Fig. 8.15 T. S. of Monocot root**

### C. Anatomy of Dicot Stem (Sunflower) :

A transverse section of dicot stem shows the following structures : **Epidermis** is single, outermost layer with multicellular having outgrowth called trichomes. A layer of cuticle is usually present towards the outer surface of epidermis. **Cortex** is situated inner to the epidermis and is usually differentiated into three regions namely, *hypodermis*, *general cortex* and *endodermis*. **Hypodermis** is situated just below the epidermis and is made of 3-5 layers of collenchymatous cells. Intercellular spaces are absent. **General cortex** is made up of several layers of large parenchymatous cells with intercellular spaces. **Endodermis** is an innermost layer of cortex which is made up of barrel shaped cells. It is also called starch sheath.



(Diagrammatic)



(Part enlarged)

Fig. 8.16 T. S. of Dicot stem

**Stele** is the central core of tissues differentiated into *pericycle*, *vascular bundles* and *pith*. **Pericycle** is the outermost layer of vascular system situated between the endodermis and vascular bundles. In sunflower, it is multilayered sclerenchymatous in the region of vascular bundles and it is called hard bast. **Vascular bundles** are conjoint, collateral, open, and are arranged in a ring. Each one is composed of xylem, phloem and cambium. Xylem is endarch. A strip of cambium is present between xylem and phloem. **Pith** is situated in the center of the young stem and is made up of large-sized parenchymatous cells with conspicuous intercellular spaces.

### D. Anatomy of Monocot Stem :

It differs from dicot. Epidermis is without trichomes and the hypodermis is sclerenchymatous. Vascular bundles are numerous and are scattered in ground tissue. Each vascular bundle is surrounded by a sclerenchymatous bundle sheath. Vascular bundles are conjoint, collateral and closed (without cambium). Xylem is endarch and shows lysigenous cavity. Pith is absent. Secondary growth is also absent.

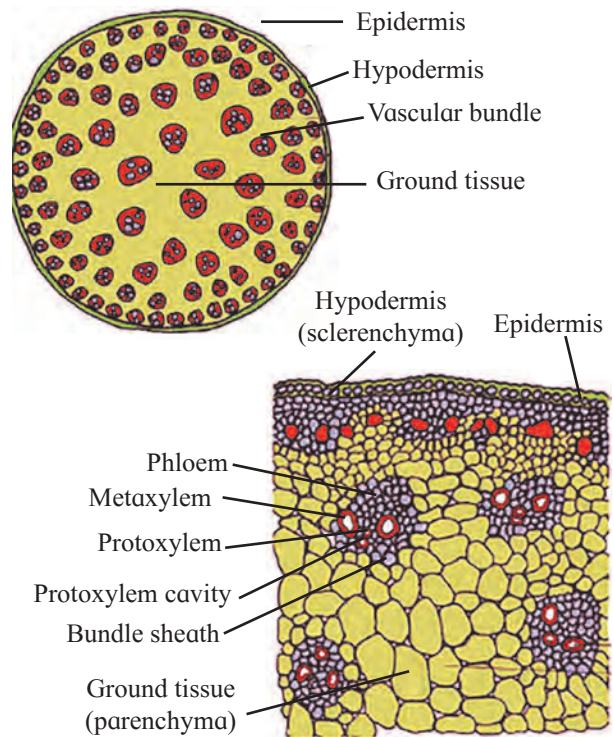


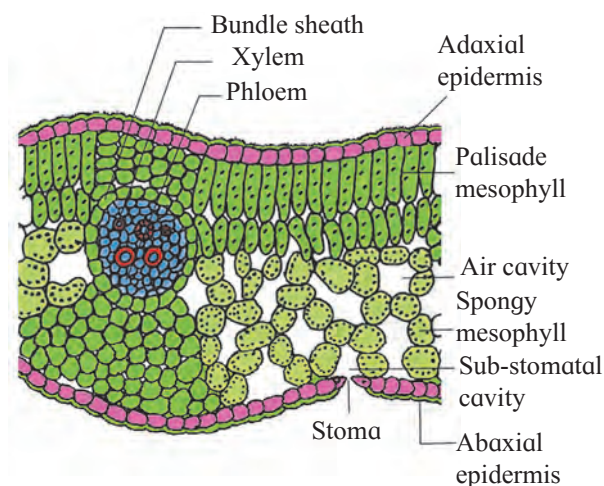
Fig. 8.17 T. S. of Monocot stem

**E. Anatomy of Leaf : Dorsiventral Leaf** is very common in dicotyledonous plants where the mesophyll tissue is differentiated into palisade and spongy parenchyma. The leaves are commonly horizontal in orientation with distinct upper and lower surfaces. The upper surface which faces the sun is darker than the lower surface.

**T. S. of Typical dicot leaf :**

**Upper epidermis** consists of a single layer of tightly packed rectangular, barrel shaped, parenchymatous cells which are devoid of chloroplast. A distinct layer of cuticle lies on the outside of the epidermis. Stomata are generally absent. Between upper and lower epidermis, there is chloroplast-containing photosynthetic tissue called **Mesophyll**.

**Mesophyll** is differentiated into palisade and spongy tissue. **Palisade parenchyma** is present below upper epidermis and consists of closely packed elongated cells. The cells contain abundant chloroplasts and help in photosynthesis. **Spongy parenchyma** is present below palisade tissue and consists of loosely arranged irregularly shaped cells with intercellular spaces. The spongy parenchyma cells contain chloroplast and are in contact with atmosphere through stomata.



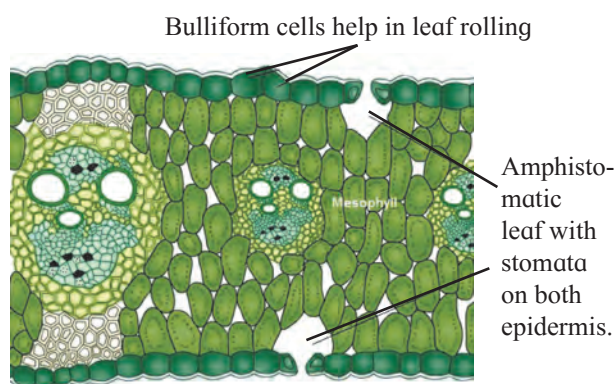
**Fig. 8.17 T. S. of dicot leaf**

**Vascular system** is made up of a number of vascular bundles of varying size depending upon the venation. Each one is surrounded by a thin layer of parenchymatous cells called bundle sheath. Vascular bundles are closed and xylem lies towards upper epidermis and phloem towards lower epidermis. Cambium is absent hence no secondary growth in the leaf.

**Lower epidermis** consists of a single layer of compactly arranged rectangular, parenchymatous cells. A thin layer of cuticle is also present. The lower epidermis contains a large number of microscopic pores called stomata. There is an air-space called sub-stomatal chamber at each stoma.

**F. Isobilateral Leaf :** In this leaf both the surfaces are equally illuminated as both the surface can face the sun, and show similar structure. The two surfaces are equally green. Generally monocotyledonous plants have isobilateral leaves.

**A typical monocot leaf :** resembles a dicot leaf in its anatomical structure. However, it shows stomata on both the surfaces and mesophyll is not differentiated into palisade and spongy tissue. It has parallel veins. These are conjoint, collateral and closed.



**Fig. 8.18 T. S. of Monocot leaf**





## Exercise

### 1. Choose the correct option

- A. Based on location or position of meristematic regions are divided into ..... types  
a. one                      b. two  
c. three                    d. none of the above
- B. Cambium is also called .....  
a. apical meristem  
b. intercalary meristem  
c. lateral meristem  
d. none of the above
- C. Collenchyma is a type of ..... tissue.  
a. living                    b. dead  
c. living and dead      d. none of the above
- D. .... is a complex permanent tissue.  
a. Parenchyma            b. Sclerenchyma  
c. Chlorenchyma        d. Xylem
- E. Mesophyll tissue is present in.....  
a. root                      b. stem  
c. leaf                      d. flower
- D. There were two cut logs of wood lying in the campus. One had growth rings and other didn't. Teacher said it is due to differences in their pattern of growth which is dependent on season. How?
- E. While on the trip to Kashmir, Pintoo observed that cut portions of large trees shows distinct rings, which he never found in Maharashtra. Why is so?
- F. A student was observing a slide with no label. The section had some vascular bundles scattered in the ground tissue. It is section of a monocot stem! He exclaimed. No! it is section of fern rachis, said the teacher. Teacher told to observe vascular bundle again. Student agreed, Why?
- G. Student found a wooden stopper in lab. He was told by an old lab attendant that it is there for many years. He kept thinking how it did not rot?
- H. Student while observing a slide of leaf section observed many stomata on the upper surface. He thought he has placed slide upside down. Teacher confirmed it is rightly placed. Explain.

### 2. Answer the following questions

- A. A fresh section was taken by a student but he was very disappointed because there were only few green and most colourless cells. Teacher provided a pink colour solution. The section was immersed in this solution and when observed it was much clearer. What is the magic?
- B. While observing a section many scattered vascular bundles could be seen. Teacher opined that in spite of this large number the stem cannot grow in girth. Why?
- C. A section of the stem had vascular bundles, where one vascular tissue was wrapped around the other. How will you technically describe it?

### 3. Write short notes on the following points

- A. Structure of stomata  
B. Secondary growth  
C. Peculiarity of a sclerenchyma cell wall

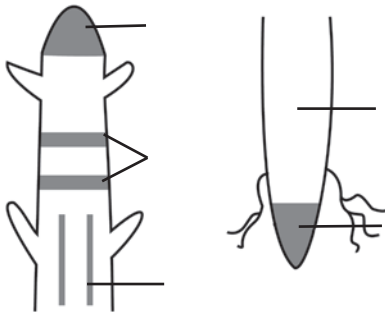
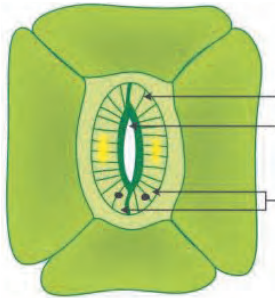
### 4. Differentiate

- A. Vascular bundle of monocot and dicot  
B. Xylem and Phloem functioning  
C. Internal or anatomical differences between monocots and dicots leaves.

**5. Draw neat labelled diagrams**

- A. T. S. of Dicot leaf.
- B. T. S. of Monocot root.
- C. T. S. of dicot stem.

**6. Write the information related parts in the diagrams given below**



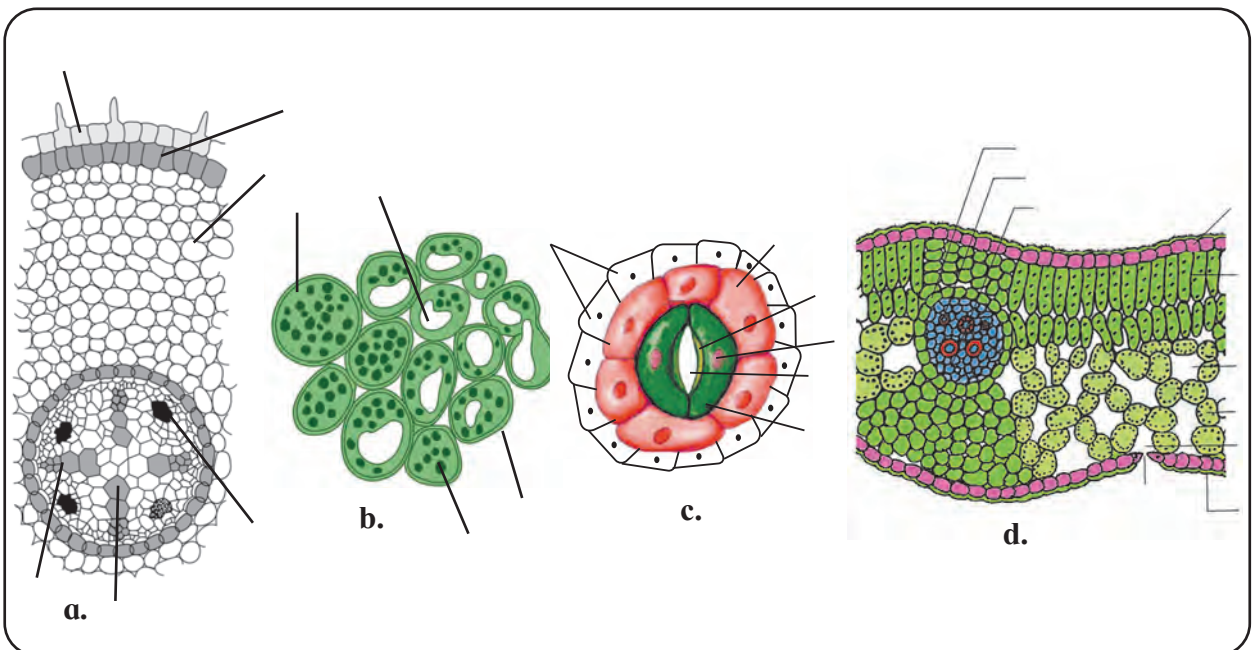
**8. Distinguish between Dicot and Monocot leaf on the basis of following characters.**

Characters	Dicot leaf	Monocot leaf
Stomata	.....	.....
Intercellular space	.....	.....
Venation	.....	.....
Vascular bundle	.....	.....
Mesophyll cells	.....	.....

**Practical / Project :**

1. Prepare detail anatomical charts with digramatic representation of dicot and monocot plants.
2. Observe different slides related to anatomy of flowering plants under the guidance of teacher.

**7. Identify the following diagrams, label it and prepare a chart of characteristics.**



## 9. Morphology of Flowering Plants



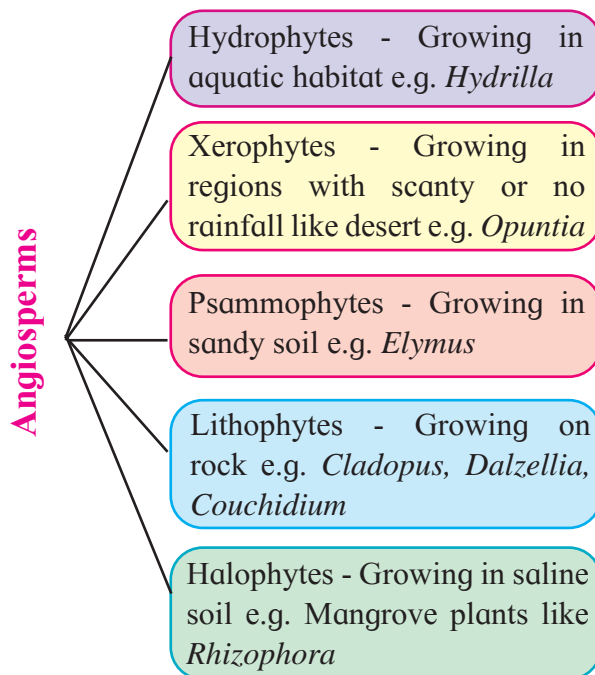
### Can you recall?

You have learnt the diversity and structure of Angiospermic plant in 6<sup>th</sup> standard.

### 9.1 Angiosperms :

Our earth has a vast diversity of plants. The flowering plants dominate the world of plants as they are well adapted to the environmental conditions. These plants show considerable variation in their general external and internal characters with respect to their habitat. Such variations help the plant body to carry out different functions. You have studied a broad classification of kingdom Plantae. Angiosperms are one of flowering plants from phanerogams.

Angiosperms can be classified into different types on the basis of habitat and it can be represented as follows :

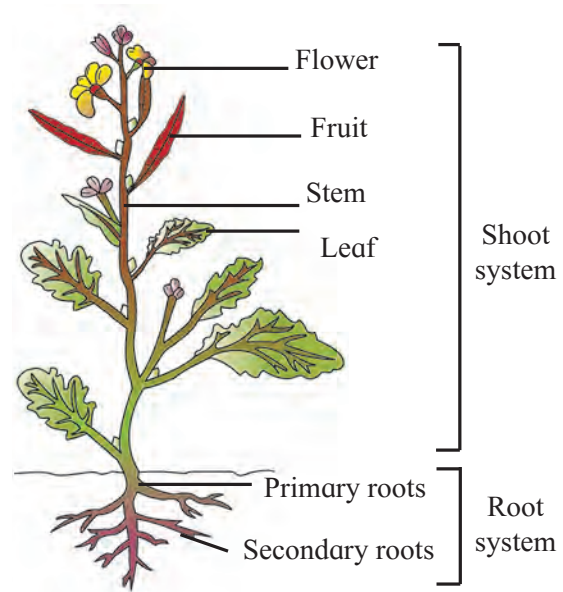


**Chart 9.1 Angiosperm classification-based on habitat**

In angiosperms seed germinates under favourable environmental conditions and produces a seedling which develops into a new plant.

### 9.2 Morphology :

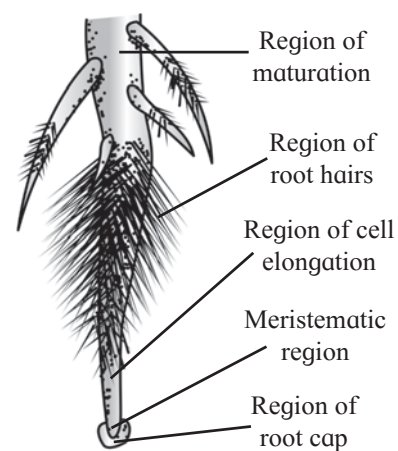
Morphologically plant shows vegetative structures like root, stem, leaf and reproductive structures such as flowers, fruits and seeds.



**Fig. 9.2 Typical Angiospermic plant**

**A. Root :** Root is descending axis of plant body which is positively geotropic and hydrotropic but negatively phototropic and aerotropic. Root grows beneath the soil surface towards gravity. Roots are generally non-green, cylindrical and without nodes and internodes.

**Typical Root Structure :** A typical root has different regions :-



**Fig. 9.3 Regions of root**

A parenchymatous multicellular structure in the form of cap, present over young growing root apex is known as **root cap**. Cell of root cap secrete mucilage for lubricating passage of root through the soil. Cells of root cap show presence of starch granules which help in graviperception and geotropic movement of root. Usually single root cap is present in plants. But in plants like *Pandanus* or screw pine multiple root caps are present. In hydrophytes root caps are replaced by root pockets e.g. *Pistia*, *Eichhornia* etc. Due to presence of root cap the growing apex of root is subterminal in position. The apex of the root is a growing point about 1 mm in length protected by root cap. This region is called as **region of cell division** or **meristematic region**. The structure is developed by compactly arranged thin walled actively dividing meristematic cells. These cells bring about longitudinal growth of root. It is followed by **Region of elongation**. This region of cells is present just above zone of cell division. The cells are newly formed and show rapid elongation to bring about increase in length of the root. The cells help in absorption of mineral salts. A **Region of root hairs / absorption/piliferous zone** is made up of numerous hair like outgrowths. The epiblema or piliferous layer produces tubular, elongated, unicellular structures known as **root hair**. They are in close contact with soil particles and increase surface area for absorption of water. Root hair are short lived or ephemeral and are replaced after every 10 to 15 days. **Region of cell maturation or differentiation** is major portion of root is developed by this region. The cells of this region are quite impermeable to water due to thick walled nature. The cells show differentiation and form different types of tissues. This region helps in fixation of plant and conduction of absorbed substances. Development of lateral roots also takes place from this region.

**Function of Root :** Roots carry out several functions which can be categorized into primary and secondary functions. Primary functions of

root are, fixation or anchorage of plant body in the soil, absorption of water and minerals from soil and conduction of absorbed materials up to the stem base etc.

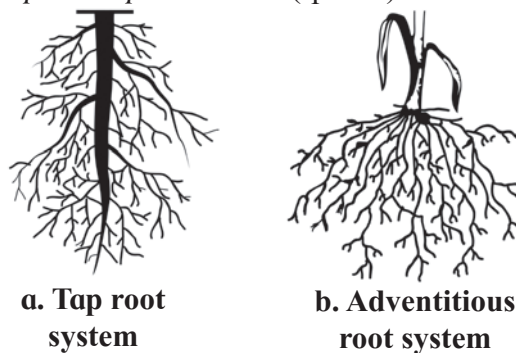
### Types of Root :

On the basis of origin, roots can be classified as **Tap roots or true roots** and **Adventitious roots**.

**a. Tap root :** The root which develops from the radicle of an embryo during seed germination is known as tap root or true root. The main root is called as primary root; its branches of first order are called as secondary roots whereas branches of second order are called as tertiary roots e.g. Pea, Bean, Sunflower etc.

The main root with all its branches constitutes tap root system. Tap root system is commonly seen in dicotyledonous plants.

**b. Adventitious roots :** A root that develops from any part other than radicle is known as **adventitious root**. Such root may develop from the base of the stem, nodes or from leaves. In monocots, radicle is short lived and from the base of stem a thick cluster of equal sized roots arise. This is adventitious root system. eg. Maize, Wheat, Sugarcane etc. It is also known as fibrous root system as they look like thin fibre. The growth of roots is superficial. Adventitious root in some plants are used for vegetative propagation. eg. *Euphorbia*, *Carapichea ipecacuanha* (Ipecac) etc.



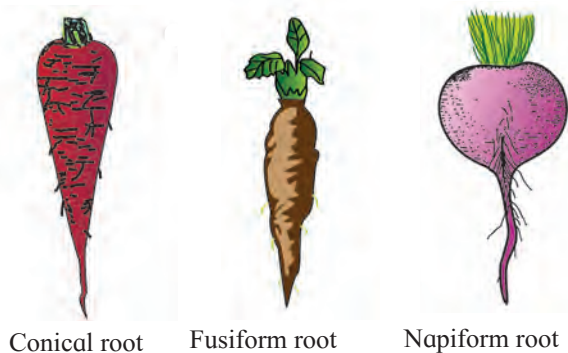
**Fig. 9.4 Types of root**

**Modification of root :** When roots have to perform some special type of function in addition to or instead of their normal function they develop some structural changes. Such roots are called as metamorphosed roots.

## Modifications of tap root

**a. Food storage :** When tap root stores food it becomes swollen fleshy and also develops definite shape. Main or primary root is the main storage organ but sometimes hypocotyl part of embryo axis also joins the main root. Secondary roots remain thin. Stem in such cases remain reduced, discoid and leaves are radicle leaves. On the basis of shape swollen tap roots are classified as **Fusiform, Conical** and **Napiform**.

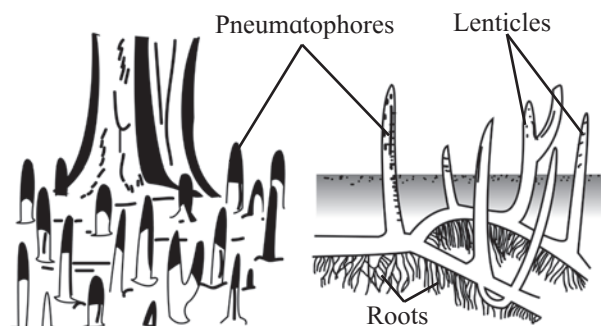
The **fusiform root** is swollen in the middle and tapering towards both ends forming spindle shaped structure. e.g. Radish (*Raphanus sativus*) The **conical root** is broad at its morphological base and narrows down towards its apex is called as conical root. e.g. Carrot (*Daucus carota*) In **napiform root**, base of root is highly swollen, almost spherical in shape and abruptly narrows down towards its apex. e.g. Beet (*Beta vulgaris*)



**Fig. 9.5 Swollen tap roots**

**b. For Respiration :** **Pneumatophores** or **Respiratory Roots** : Halophytes are the plants which grow in saline swamps, marshy places and salt lakes. These plants produce special kind of roots called as pneumatophores or breathing roots. The main root system of these plants do not get sufficient air for respiration as soil is water logged. Due to this, mineral absorption of plant also gets affected.

To overcome this problem underground roots develop special roots which are negatively geotropic; growing vertically upwards. These roots are conical projections present around main trunk of plant.

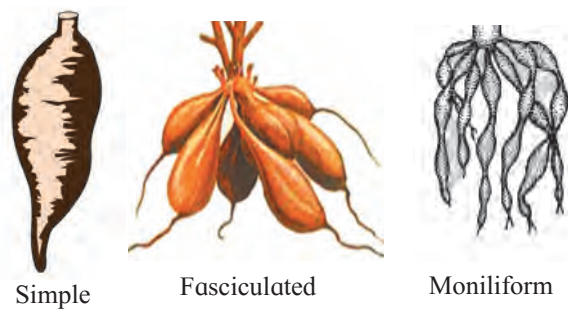


**Fig. 9.6 Respiratory roots**

The roots show presence of lenticles i.e. minute pores for gaseous exchange (Pneumatic - Hollow, phore - stalk) e.g. *Rhizophora*, *Avicennia*, *Sonneratia*, *Heritiera* (ver. *sundri*) etc.

## Modifications of Adventitious Roots :

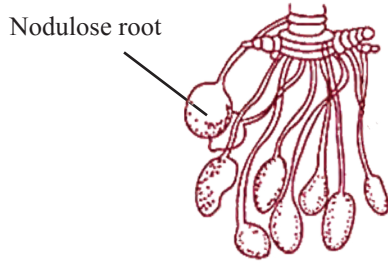
**a. Food storage :** Fibrous roots also show food storage like tap root but the main difference is that fibrous root usually do not develop definite shape. These roots are further classified as **Simple tuberous, Fasciculated tuberous, Beaded** and **Nodulose roots**.



**Fig. 9.7 Tuberous root**

Simple tuberous roots become swollen and do not show definite shape. They are produced singly. The roots arise from nodes over the stem and penetrate into the soil. E.g. sweet potato or shakarkand (*Ipomoea batatas*). A cluster of roots arising from one point which becomes thick and fleshy due to storage of food is known as **fasciculated tuberous root**. These clusters are seen at the base of the stem. E.g. *Dahlia*, *Asparagus*, etc. The beaded roots are also called as **moniliform roots**. These roots show swellings at regular intervals like beads of a necklace. e.g. *Spinacia oleracea* (Indian Spinach).

The cluster of long slender roots become enlarged at the tips forming nodules is known as **nodulose roots**. E.g. Arrow (*Maranta root*) Amhaldi (*Curcuma amada*).



**Fig. 9.8 Nodulose root**



**Do you know ?**

A banyan tree growing in the Indian Botanical Garden, howrah (Kolkata) has nearly 1700 such prop roots. The crown of tree has a large circumference. The tree is about 200 years old.

**b. For mechanical support :**

**1. Prop roots/ Columnar roots :** These roots arise from horizontal branches of tree like Banyan tree (*Ficus benghalensis*) and grow vertically downwards till they penetrate the soil. These prop roots show secondary growth, become thick, act like pillars to provide mechanical support to the heavy branches.



**Fig. 9.9 Banyan tree**

**2. Stilt roots :** These roots normally arise from a few lower nodes of a weak stem in some monocots shrubs and small trees. They show obliquely downward growth penetrating soil and provide mechanical support to the plant. In the members of family Poaceae, the plants like Maize, Jowar, Sugarcane etc. produce stilt root in whorl around the node.



**Fig. 9.10 Maize plant roots**

These roots provide additional support to the plant body. In Screw pine or *Pandanus* (Kewada), stilt roots arise only from the lower surface of obliquely growing stem for additional support. These roots show multiple root caps.

**3. Climbing roots :** Different climbers with weak stem produce roots at their nodes by means of which they attach themselves to support and thereby raise themselves above the ground e.g. Betel leaf or Pan, black pepper or *Piper nigrum* (Kali Mirch), Pothos or money plant.



**Fig. 9.11 Climbing roots (Betel leaf)**

**4. Clinging Roots :** These tiny roots develop along internodes, show disc at tips, which exude sticky substance. This substance enables plant to get attached with walls of buildings. They do not damage substratum. e.g. English Ivy (*Hedera helix*).



**Fig. 9.12 Clinging roots**

**5. Plank Roots/Buttresses :** Often develop at the base of large trees form plank like extensions around stem. e.g. Silk cotton, Pipal etc.



**Fig. 9.13 Plank roots**

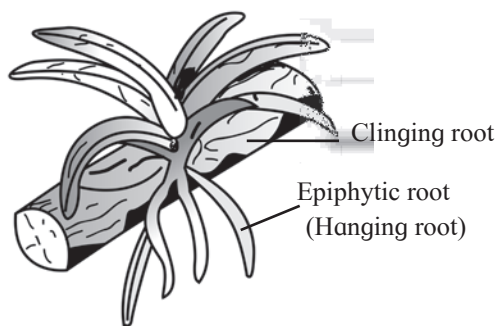
**6. Buoyant roots :** Roots developed at the nodes of aquatic herbs like (*Jussiaea repens*), become highly inflated and spongy providing buoyancy and helping the plant to float.



**Fig. 9.14 Spongy roots**

**c. For special functions :**

**1. Epiphytic roots :** Small epiphytic plants such as orchids growing on the branches of huge trees in dense rain forests are unable to obtain soil moisture. They produce specialized root to hang in the air. The roots are provided with a spongy membranous absorbent covering of the velamen tissue. The cells of velamen absorb moisture from air. Velamen tissue is hygroscopic and show porous walls. The roots may be silvery white or green but without root cap e.g. *Vanda*, *Dendrobium* etc.



**Fig. 9.15 Epiphytic roots**

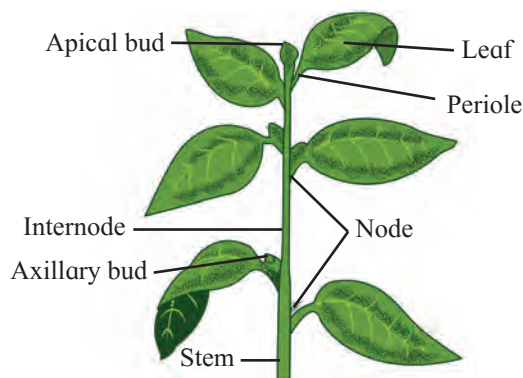
**2. Sucking roots or Haustoria :** Specialised microscopic sucking roots developed by parasitic plants to absorb nourishment from the host. *Viscum album* is a partial parasite. It develops haustoria which penetrate into xylem of host plant for absorption of water (nutrients). In *Cuscuta reflexa* or Dodder (*Amarvel*) haustoria penetrates vascular strand and suck food from phloem, water and minerals from xylem. *Cuscuta* is leafless plant with yellow stem. It is a total parasite.



**Fig. 9.16 Sucking roots**

**B. Stem :** The aerial part of the plant body is known as shoot system. Stem is the main axis of this shoot system. Stem is the ascending part of the plant body which develops from plumule and bears reproductive units i.e. buds. It is differentiated into nodes and internodes. It is usually positively phototropic, negatively geotropic and negatively hydrotropic. It shows different types of buds (axillary, apical, accessory, etc.). At nodes, it produces dissimilar lateral organs such as leaves and flowers and similar organs such as branches. Young stem is green and capable of photosynthesis.

The primary functions of the stem are to produce and support branches, leaves, flowers and fruits; conduction of water and minerals and transportation of food to plant parts.



**Fig. 9.17 Stem structure**

**Modifications of stem :** Stem develops some modifications for additional or accessory functions. To perform such function stem shows different modifications :

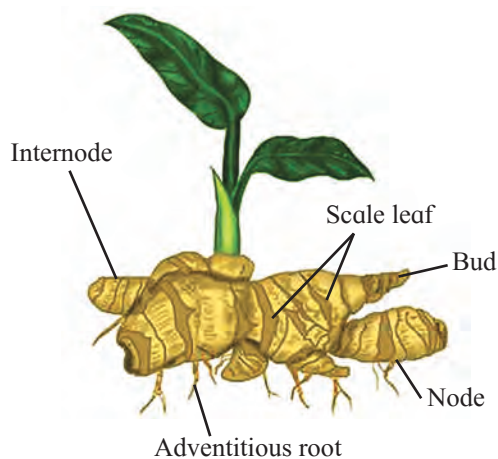
**a. Underground stem :** In some herbaceous plants stem develops below the soil surface called as underground stem. Underground stem remains dormant during unfavourable condition and on the advent of favourable condition produces aerial shoots. Underground stem is known to store food, helps in perennation and vegetative propagation.



**Use your brain power**

Why underground stem is different from roots?

**1. Rhizome :** It is prostrate, dorsiventrally thickened and brownish in colour. It grows either horizontally or obliquely beneath the soil. Rhizome shows nodes and internodes, scale leaves and bears terminal and axillary buds at nodes. Terminal bud under favourable conditions produces aerial shoot which degenerates at the end of favourable condition. Growth of rhizome takes place with lateral buds such growth is known as sympodial growth. e.g. Ginger (*Zingiber officinale*), Turmeric (*Curcuma domestica*), Canna etc. In plants where rhizomes grows obliquely, terminal bud brings about growth of rhizomes. This is known as monopodial growth. e.g. *Nymphaea*, *Nelumbo* (Lotus), *Pteris* (Fern) etc.



**Fig. 9.18 Rhizome of Ginger**

**2. Stem Tuber :** Special underground branches of stem at their tips become irregularly swollen due to storage of food material which is mostly starch. Presence of distinct nodes but not internodes classifies tuber as stem. At nodal part scale leaves are present with axillary buds commonly known as ‘eyes’. ‘Eyes’ can produce aerial shoots under favourable conditions. Tubers are propagated vegetatively e.g. Potato (*Solanum tuberosum*), Matalu (*Helianthus tuberosus*). Tuber has two distinct ends viz. apical end and basal end called as rose and heel end respectively. The number of nodes and eyes is more towards rose end.



**Fig. 9.19 Tuber of potato**

**3. Bulb :** Bulb is an underground spherical or pyriform stem. Stem is highly reduced and discoid. It bears a whorl of fleshy leaves. The scale leaves or fleshy leaves show concentric arrangement over the stem. These store food material. Some outer scale leaves become thin and dry. The reduced stem produces adventitious roots at its base. The bulb is of different types **Tunicated or layered bulb** is made up of fleshy leaves arranged in concentric manner with outer dry scale leaf. e.g. Onion. In garlic the bulb is **scaly** or **compound tunicated**. The fleshy scales (cloves) are arranged in overlapping pattern.



**a. Scaly bulb e.g. Garlic**

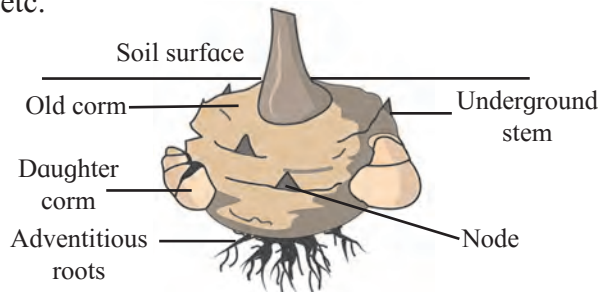


**b. Tunicate bulb e.g. Onion**

**Fig. 9.20 Bulbs**



**4. Corm :** Corm is swollen underground spherical or subspherical internode of vertically growing stem. It is condensed structure with circular or ring like nodes. Presence of axillary buds and scales is observed. Adventitious buds are produced which help in vegetative propagation. Adventitious roots are produced at lower part of stem e.g. *Colocasia* (Arbi), *Amorphophallus* (Zamikand or Elephant foot) etc.

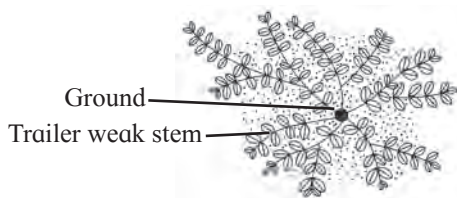


**Fig. 9.21 Corm**

**b. Sub aerial stem :** The stems are generally weak or straggling stems growing over the ground and need support for perpetuation. Sometimes these stems are found to grow beneath the soil surface also. Thus they show contact with both air and soil. Sub aerial stems are meant for perennation and vegetative propagation. Scale leaves and axillary buds are present over stem surface. The latter produces aerial shoots.

**The different types of sub aerial shoots are as follows:**

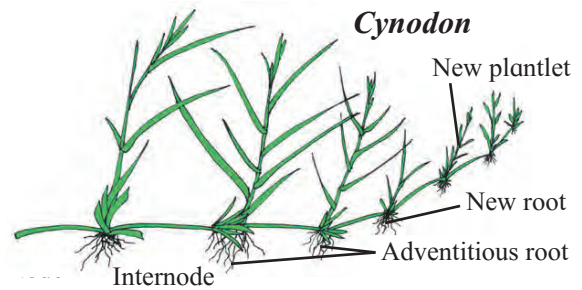
**1. Trailer :** The shoot spreads over the ground without intervals. The branches are either flat i.e. procumbent or partly vertical i.e. decumbent e.g. *Euphorbia*, *Tridax* etc.



**Fig. 9.22 Euphorbia**

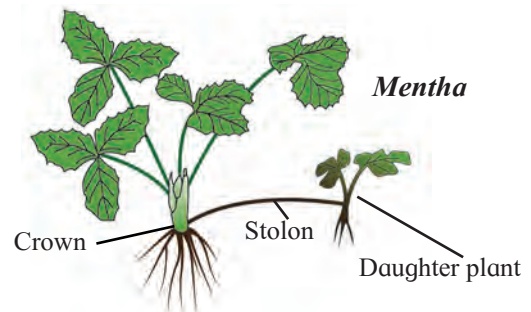
**2. Runner :** They are special narrow, prostrate or horizontal green branches which develop at the base of erect shoots known as crown. Runners spread in all directions to produce new crowns with bunch of adventitious roots.

Presence of nodes with scale leaves and axillary buds is observed. Eg. *Cynodon* (Lawn grass) *Centella* (Hydrocotyl), *Oxalis* etc.



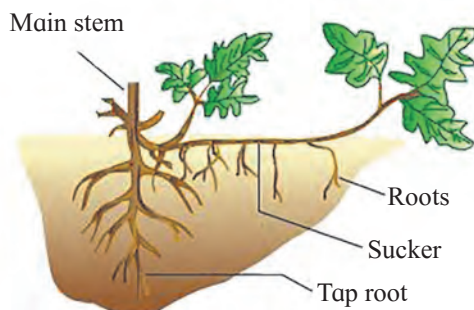
**Fig. 9.23 Runner**

**3. Stolons :** The slender lateral branch arising from the base of main axis is known as stolon. In some plants it is above ground (wild strawberry). Primarily stolon shows upward growth in the form of ordinary branch, but when it bends and touches the ground terminal bud grows into new shoot and adventitious roots e.g. *Mentha*.



**Fig. 9.24 Stolon**

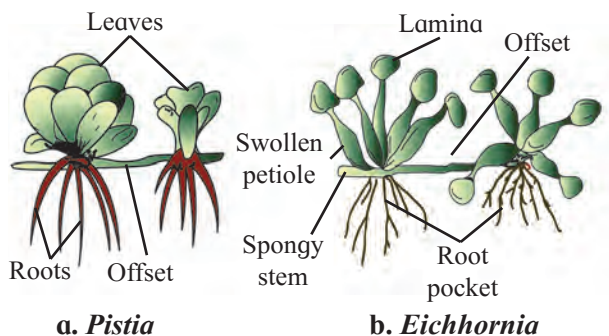
**4. Sucker :** It is non green runner like branch of stem which develops from underground base of roots. It grows horizontally below soil and finally comes above the soil surface to produce a new plant. Sucker can be termed as underground runner eg. *Chrysanthemum*, Banana etc.



**Chrysanthemum**

**Fig. 9.25 Sucker**

**5. Offset :** These are one internode long runners in rosette plants at ground or water level. Offset helps in vegetative propagation e.g. Water hyacinth or Jal kumbhi (*Eichhornia*) and *Pistia*.



**Fig. 9.26 Offset**

**c. Aerial modification :** Stem or its vegetative part modify to carry out specialized functions. They develop various modifications for this purpose. Such modified stems are called as metamorphosed stems. The different modifications can be discussed as under :

**1. Thorn :** It is modification of apical or axillary bud. Thorn is hard pointed and mostly straight structure (except *Bougainvillea* where it is curved and useful for climbing). It helps in reducing transpiration and being hard and pointed, provides protection device against browsing or marauding animals. Apical bud develops into thorn in *Carrisa* whereas axillary bud develops into thorn in *Duranta*, *Citrus*, *Bougainvillea*, etc.



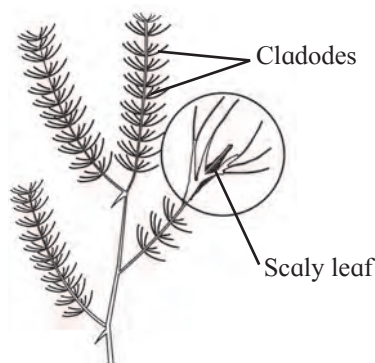
**Fig. 9.27 Thorn**

**2. Phylloclade :** Modification of stem into leaf like photosynthetic organ is known as phylloclade. Being stem, it possesses nodes and internodes. It is thick, fleshy and succulent, contains mucilage for retaining water e.g. *Opuntia*, cylindrical in *Casuarina* and ribbon like in *Muehlenbeckia*.



**Fig. 9.28 Phylloclade**

**3. Cladodes :** The branches of limited growth i.e. one internode long and performing photosynthetic function are called as cladodes. True leaves are reduced to spine or scales. E.g. *Asparagus*.



**Fig. 9.29 Cladodes**



**Use your brain power**

Why the stem has to perform photosynthesis in xerophytes?

**4. Cladophylls :** These are leaf like structures borne in the axil of scale leaf. It has floral bud and scale leaf in the middle i.e. upper half is leaf and lower half is stem. e.g. *Ruscus*.



**Fig. 9.30 Cladophylls**

**Stem tendrils :** Tendrils are thin, wiry, photosynthetic, leafless coiled structures. They give additional support to developing plant. Tendrils have adhesive glands for fixation.



Apical bud in *Vitis quadrangularis* gets modified in to tendril. The further growth is carried out by axillary bud. This branching pattern is termed dichotomous.

Axillary tendril in *Passiflora* axillary bud gets modified in tendril



Extra axillary bud is the one which grows outside the axil. This bud in *Cucurbita* gets modified in to tendril.



Normally floral buds are destined to produced flowers. But in plants like *Antigonon* they produce tendrils.

**5. Bulbils :** In plants like *Dioscorea*, axillary bud becomes fleshy and rounded due to storage of food called as bulbil. When it falls off it produces new plant and help in vegetative propagation.



**Fig. 9.31 Bulbils**

### C. Leaf :

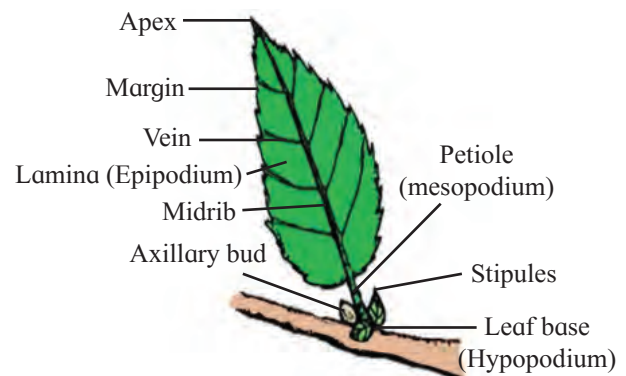
Leaves are the most important appendages as they carry out photosynthesis and also help to remove excess amount of water from plant body. Leaf develops from leaf primordium. Leaf is dorsiventrally flattened lateral appendage of stem. It is produced at nodal region. Leaf is thin, expanded and green due to presence of photosynthetic pigments. It shows exogenous origin. Axil of leaf shows presence of axillary bud. Leaf shows limited growth, does not show apical bud or a growing point.

**1. Typical leaf structure :** It shows presence of three main parts **Leaf base or Hypopodium, Petiole or Mesopodium and Leaf lamina/blade or epodium.**

**Leaf base :** The point by which leaf remains attached to stem is known as leaf base.

The nature of leaf base is varies in different plants. It may be pulvinus (swollen), sheathing or ligulate etc.

In some plants leaves possess a pair of lateral outgrowths called as **stipules**. The leaf with stipule is said to be **stipulate** and without stipule is **exstipulate**. Stipules are normally green protective structure.



**Fig. 9.32 Structure of typical leaf**

**Petiole or mesopodium :** The part of leaf which connect leaf lamina with the leaf base is known as petiole of leaf. A leaf with petiole is **petiolate** and a leaf without petiole is termed as **sessile** leaf.

Petiole helps lamina to get exposed to light and also helps in conduction.

**Lamina or epodium :** Large expanded, flat and green part of leaf. The lamina surface plays important role in photosynthesis, gaseous exchange and transpiration. Anatomically, the leaf is either dorsiventral or isobilateral. Dorsiventral leaf is common in Dicots and isobilateral in Monocots.

Centric or cylindrical leaves are those in which both the surfaces of leaf cannot be distinguished distinctly. Leaf lamina varies greatly in shape, margin and apex.

**2. Leaf venation :** Arrangement of veins and veinlets in leaf lamina, is known as venation. Veins are responsible for conduction of water and minerals as well as food. The structural framework of the lamina is developed by veins.

**Internet my friend**

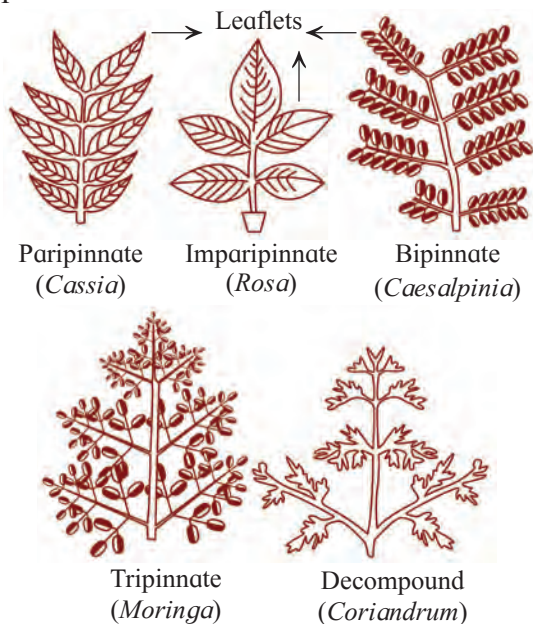
Collect information of types of leaf venation.

R	P

**3. Types of leaf :** Based on incision of lamina leaves are of two main types. i.e. simple and compound. The leaf with entire lamina is called **simple leaf** and leaf in which lamina is divided into number of **leaf lets** called as compound leaf.

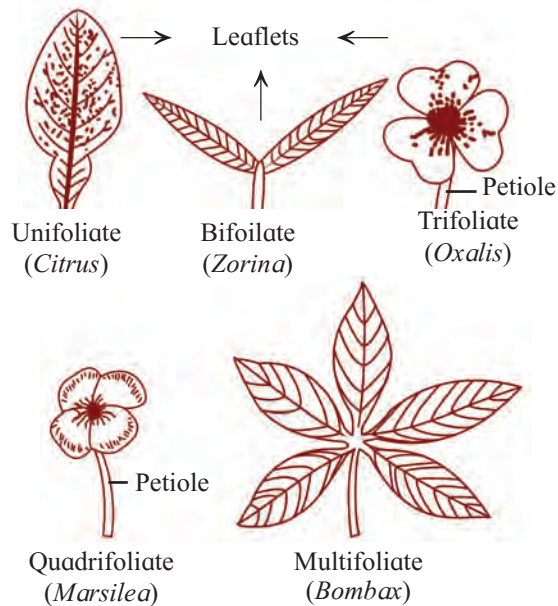
Compound leaves are of two types..

**a. Pinnately compound :** Leaflets are present laterally on a common axis called rachis, which represents the midrib of the leaf.



**Fig. 9.33 (a) Types of Compound leaf**

**b. Palmately compound :** In which all the leaflets are attached at tip of petiole.



**Fig. 9.33 (b) Types of Compound leaf**

**4. Modification of leaves :** Apart from photosynthesis, leaf also performs transpiration gaseous exchange and perception of light for flowering. However leaves may undergo modifications to perform several other functions. As per the modification their are different types of leaves shown below.

**a. Leaf spines:** Sometimes entire leaf is modified into spines (*Opuntia*) or margin of leaf becomes spiny (*Agave*) or stipule modifies into spine (*Acacia*) to check the rate of transpiration or to protect plant from grazing. E.g. *Zizyphus* etc.



**Fig. 9.34 Leaf Spines**

**b. Leaf tendril:** In some weak stems for providing additional support; leaf, leaflet or other part modifies to produce thin, green, wiry, coiled structure called as leaf tendril. It helps in climbing.



**Whole leaf tendril**  
E.g. *Lathyrus*



**Leaflet tendril**  
E.g. *Pisum sativum*



**Leaf tip tendril**  
E.g. *Gloriosa*



**Stipular tendril**  
E.g. *Smilax*

**Fig. 9.35 Leaf tendrils**

**c. Leaf hooks:** In plants like *Bignonia unguis-cati* (Cat's nail) the terminal leaflets get modified into three stiff, curved and pointed hooks used to cling over bark of tree.



**Fig. 9.36 Leaf hooks**

**d. Phyllode:** When petiole of leaf becomes flat, green and leaf like it is called as phyllode. In *Acacia auriculiformis* the normal leaf is bipinnately compound and falls off soon. The petiole modifies itself into phyllode. It is xerophytic adaptation.



**Fig. 9.37 Phyllode**

**5. Phyllotaxy :** Arrangement of leaves on the stem and branches in a specific manner is known as phyllotaxy. It enable leaf to get sufficient light.



**Alternate**  
Single leaf from each node E.g. Mango



**Whorled**  
Many leaves from each node E.g. *Nerium*



**Opposite decussate**  
A pair of leaf from each node and the consecutive pair at right angle E.g. *Calotropis*



**Opposite superposed**  
A pair of leaf from each node and the consecutive pair is arranged just above. E.g. Jamun

**Fig. 9.38 Types of phyllotaxy**

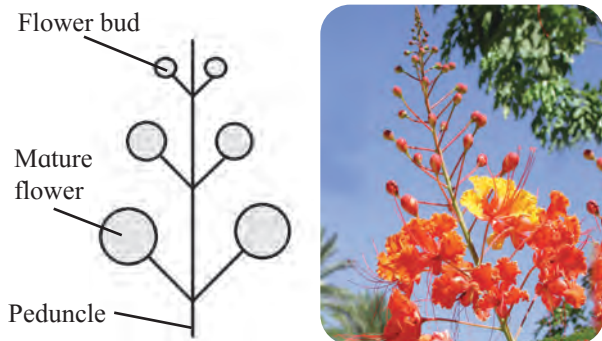
#### **D. Inflorescence :**

A specialised axis or branch over which flowers are produced or borne in definite manner is known inflorescence. Inflorescence has two parts **Peduncle and flowers**. There are basic types of inflorescence.

All the flowers do not mature at same time. Chances of pollination increase and large number of flowers can be pollinated in single visit and also makes the plant attractive.

## Types of inflorescence :

**a. Racemose :** Growth of peduncle is infinite or unlimited. Apical bud is free for continuous growth. Older flowers at the base. Flowers are borne in acropetal succession. Order of opening is centripetal, when peduncle is disc shaped.



**Fig. 9.39 Racemose**

**b. Cymose :** Growth of peduncle is finite or limited. Apical meristem terminates into flower. Oldest flower is the apex. Flowers are borne in basipetal succession. Order of opening is centrifugal, if peduncle is compressed from the top.

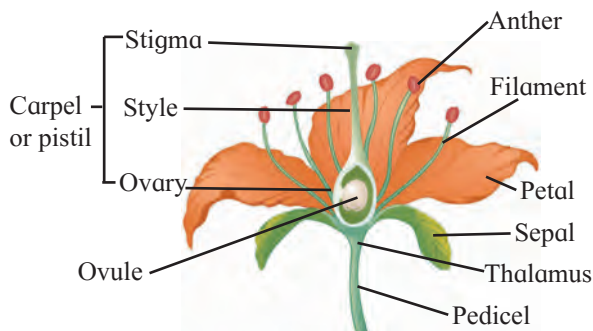


**Fig. 9.40 Cymose**

**E. Flower :** Flower is highly modified and condensed shoot meant for sexual reproduction.

On the basis of position, a flower can be axillary or terminal. In a typical flower, the thalamus (Consists of four compactly arranged nodes and three highly condensed internodes. From each node of thalamus, a circle or whorl of modified leaves is produced.

A flower may or may not show presence of bract at base of pedicel or over the pedicel, such a flower is said to be **bracteate** or **ebracteate** respectively. A flower with pedicel is said to be **pedicellate** flower and without pedicel is called as **sessile** flower.



**Fig. 9.41 Typical Flower (Diagrammatic)**

Flower with bilateral symmetry is called zygomorphic flower e.g. Sweet pea where there is only one plane along which if flower is cut, shows mirror images. Flower with radial symmetry where it can be cut along diameter in any plane and shows mirror images. It is called actinomorphic flower e.g. *Hibiscus*.

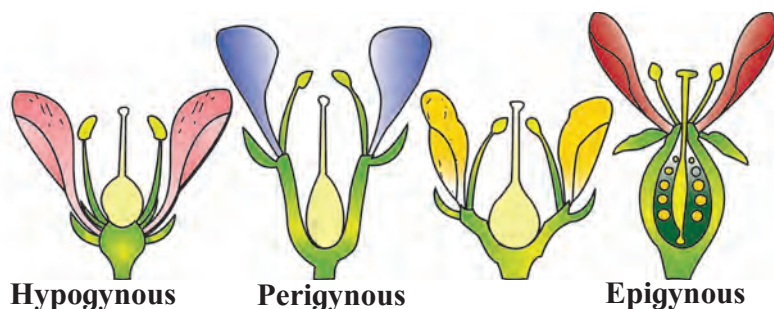


## Always Remember

### Terminologies related to flower :

1. Complete : Presence of all four floral whorls.
2. Incomplete : Absence of any one of the floral whorl.
3. Perfect : Both androecium and gynoecium are present in a flower; also called monoecious or bisexual flower.
4. Imperfect : Any one reproductive whorl is present in a flower; also called as dioecious flower or unisexual flower.
5. Unisexual : It can be either staminate (male)/ pistillate (female) flower; also called dioecy.
6. Neuter : When both reproductive whorls are absent, it is said to be neuter flower e.g. Ray florets of *Tagetes* (marigold).
7. Monoecious plant : Male and female reproductive flowers are borne on same plant. E.g. Maize.
8. Dioecious plant : Only one type of unisexual flowers are present on a plant e.g. Date palm, papaya.

**a. Insertion of floral whorls :** The position and arrangement of rest of the floral whorls with respect to gynoecium on the thalamus is known as insertion of floral whorls. In a typical flower thalamus consist of four compactly arranged



**Fig. 9.42 Insertion of floral whorls**

nodes and three internodes. Shape of thalamus decides insertion of floral whorls.

**a. Hypogyny :** When the convex or conical thalamus is present in flower, ovary occupies the highest position while other floral parts are below ovary. Ovary is said to be superior and flower is called as **hypogynous** flower. E.g. Brinjal, Mustard, China rose etc. It is denoted as  $\underline{G}$  in floral formula.

**b. Perigyny :** When cup shaped or saucer shaped thalamus is present in a flower, ovary and other floral parts occupy about same position. Such an ovary is said to be semi-superior or semi-inferior. All floral whorls are at the rim of thalamus. Flower is perigynous e.g. Rose, Pea, Bean, etc. It is denoted as  $\bar{G}$  in floral formula.

**c. Epigyny :** When closed cup like thalamus completely encloses ovary and may show fusion with wall of ovary the other floral parts occupy superior position and ovary becomes inferior. Such flower is said to be epigynous flower, e.g. Sunflower, Guava etc. It is denoted as  $\bar{G}$  in floral formula.

**b. Floral parts and their structure :** All floral parts are developed from thalamus from different nodes. From each node of thalamus circle or whorl of modified leaves is produced. Thalamus is called as **torus** or **receptacle**. Thalamus is green in colour hence it can perform the process of photosynthesis.



**Do you know ?**

Mango is polygamous plant and produces all types of flowers, staminate, bisexual and neuter.

**1. Calyx (K) :** It is outermost floral whorl and individual members are known as sepals. Sepals are usually green in colour and perform photosynthesis. If all the **sepals** are **united**, the condition is gamosepalous and if they are **free**, the condition is called as **polysepalous**. Gamosepalous calyx is found in china rose and polysepalous calyx is found in *Brassica*.

The main function of sepals is to protect inner floral parts in bud condition. Sometimes sepals become brightly coloured (petaloid sepals) and attract insects for pollination e.g. *Mussaenda*. Calyx i.e. Sepals modify into stiff, hairy structures called **pappus**. Such persistent calyx helps in wind dispersal of fruits. E.g. *Tridax*, *Sonchus*.





**2. Corolla (C):** It is second floral whorl from outer side and variously coloured. The individual member is called as **petal**. Petals may be sweet to taste, possess scent, odour, aroma or fragrance etc. The condition in which petals are free is said to be **polypetalous** (e.g. Rose) and if they are fused, it is called as **gamopetalous** (e.g. *Datura*). The main function of corolla is to attract different agencies for pollination.

**Perianth (P) :** Many times calyx and corolla remain undifferentiated. Such member is known as tepal. The whorl of tepals is known as **Perianth**.



**Do you know ?**

Type of Calyx	Nature of Sepals	Example
Caducous	Sepals fall off as soon as the flower bud opens.	e.g. <i>Argemone</i> (Poppy)
Deciduous	Sepals survive till (withering of petals) fruit formation	e.g. <i>Lotus</i> , Mustard
Persistent	Sepals remain even after fruit formation	e.g. Brinjal, Pea, etc.

	<p><b>Valvate</b> : Margins of sepals or petals remain either in contact or lie close to each other but do not overlap. e.g. Calyx of <i>Datura</i>, <i>Calotropis</i>.</p>
	<p><b>Twisted</b> : Margins of each sepal or petal is directed inwards and is overlapped. While the other margin is directed outwards and overlap the margin of adjacent. e.g. Corolla of China rose, Cotton etc.</p>
	<p><b>Imbricate</b> : One of the sepals or petals is internal and is overlapped at both the margins. One is external i.e. completely outside Rest of the members. Overlap and get overlapped. e.g. Calyx of Cassia, <i>Bauhinia</i>, etc.</p>
	<p><b>Vexillary</b> : Corolla is butterfly shaped and consists of five petals. Outermost and largest is known as standard or vexillum, two lateral partly overlapping petals are wings and two smaller inner, and fused forming boat shaped structures keel. e.g Corolla of <i>Pisum sativum</i></p>

**Table 9.43 Arrangement of sepals, petals or tepals**

If all the tepals are free the condition is called as **polyphyllous** and if they are fused the condition is called as **gamophyllous**. Sepaloid perianth shows green tepals while petaloid perianth brightly coloured tepals. E.g. *Lily*, *Amaranthus*, *Celosia*, etc. It protects other floral whorls. Petaloid tepal helps in pollination and sepaloid tepals can perform photosynthesis.

**Aestivation** : The mode of arrangement of sepals, petals or tepals in a flower bud with respect to the members of same whorl is known as aestivation. (Refer table 9.42)

**Epicalyx** : It is an additional whorl of sepal like structures formed by bractioles which occurs on the outside of calyx. These are 5-8 in number. It is a characteristic feature of family Malvaceae. They are protective in function. e.g. Ladies finger

**3. Androecium (A)**: It is third floral whorl from outer side. Androecium is male reproductive part of a flower. The individual member is known as **stamen**. If all the stamens are free the condition is **polyandrous**

**(Cohesion = Fusion between members of a same whorl.**

**Adhesion = Fusion between members of different whorls)**

**Typical stamen shows three different parts :**

**1. Anther** : It is terminal in position. Anther produces pollen grains in its locules. It is usually bilobed. Each lobe contains two locules, hence anther is tetralocular/ tetrasporangiate structure. e.g. *Datura*. In some plants there is single anther lobe having two locules. Some other times, anther lobe has only one locule. Then it is called monothealous, formed due to fusion of two locules. e.g. *Hibiscus*.

**2. Filament** : It is a stalk of stamen and bears anther at its tip. It raises anther to a proper height for easy dispersal of pollen grains.

**3. Connective** : It is in continuation of the filament. It is similar to mid rib and connects two anther lobes together and also the anther with the filament.

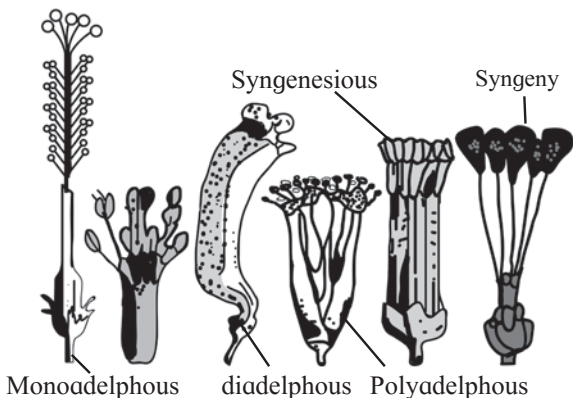
**Cohesion of stamens** : When stamens are united by filaments and anthers are free, the condition is **adelphous**.

**Adhesion of stamens** : When the stamens are united with petals or tepals they are described as epipetalous (e.g. *Datura*) or epiphyllous (e.g. *Lily*).

**Syngeneis and Synandrous** : When anthers are united and filaments are free, it is known as **syngeny**. e.g. Sunflower. Stamens are fused



by both filaments and anthers in **syndrous** conditions e.g. *Cucurbita*.



**Fig. 9.44 Cohesion of Stamens**

**4. Gynoecium (G):** It is the female reproductive part of flower and innermost in position. It is also known as **pistil**. The individual member of gynoecium is known as **carpel**. The number of carpels may be one to many. If all the carpels are fused the condition is described as **syncarpous** and if they are free the condition is described as **apocarpous**. The polycarpellary gynoecium can be bicarpellary (two carpels e.g. *Datura*) tricarpellary (three carpels e.g. *Cucurbita*), pentacarpellary (five carpels e.g. *Hibiscus*) and so on.

A typical carpel consists of three parts viz, stigma, style and ovary. Stigma is a terminal part of carpel which receives pollen grains during pollination. It helps in germination of pollen grain. Stigma shows variation in structure to suit the pollinating agent. Style is narrow thread like structure that connects ovary with stigma. Ovary is basal, swollen, fertile part of the carpel. Ovules are produced in an ovary on a soft fertile tissue called placenta.

**Placentation :** The mode of arrangement of ovules on the placenta within the ovary, is placentation.

**Types of Placentation :**

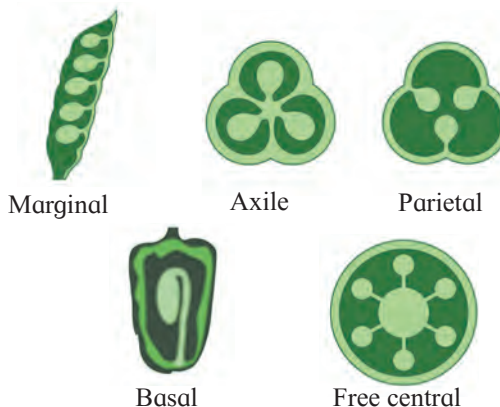
**Marginal :** Ovules are placed on the fused margins of unilocular ovary. e.g. Pea, Bean etc.

**Axile :** Ovules are placed on the central axis of a multilocular ovary. e.g. Chinarse, Cotton; etc.

**Parietal :** Ovules are placed on the inner wall of unilocular ovary of multicarpellary syncarpus gynoecium. e.g. Papaya, Cucumber,

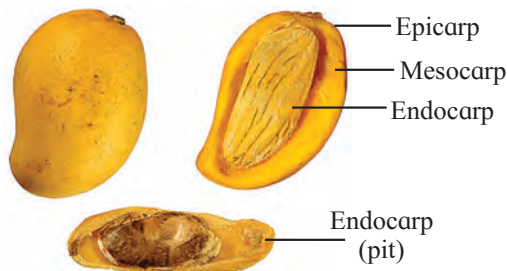
**Basal :** Single ovule is present at the base of unilocular ovary. e.g. Sunflower, Rice, Wheat.

**Free central :** Ovules are borne on central axis which is not attached to ovary wall. e.g. *Argemone*, *Dianthus*, *Celosia*.

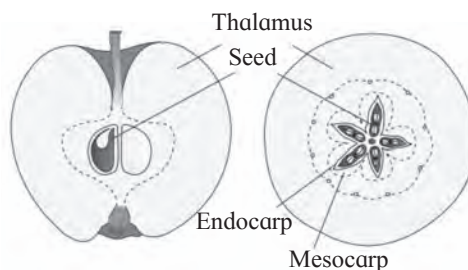


**Fig. 9.45 Types of placentation**

**F. Fruit :** Angiosperms produce fruit, after fertilization, from ovary. Sometimes fruit is produced from ovary without fertilization. Such types of fruits are called as **parthenocarpic fruits** and the phenomenon is called parthenocarpy. E.g. Cultivated varieties of Banana and seedless Grapes. The fruit that develops only from ovary, is true fruit. e.g. Mango. The fruit which develops from other floral parts than ovary, is called false fruit or pseudocarp. e.g. Apple.



**Fig. 9.46 Mango**



**Fig. 9.47 Apple**



## Observe and Discuss

### Types of fruits



A typical true fruit has a protective wall (pericarp) and seed/s. In fleshy fruits, pericarp is further divided in outer epicarp, middle mesocarp and inner endocarp. e.g. Mango

Fruits can develop from one ovary of one flower. Such fruits are **simple fruits**. Simple fruits are further classified on the basis of their pericarp. Those having thin pericarp are dry fruits but those with thick pericarp are fleshy fruits. In dry fruits, the pericarp becomes dry and thin. It breaks open (dehiscent) at maturity. But in some others, it does not break open (indehiscent). e.g. Achene (*Mirabilis*), Caryopsis (Maize) and Cypsela (Sunflower) are indehiscent fruits. Capsule (Lady's finger) and legume (Pea) are dry dehiscent fruits. In fleshy fruits berry (Tomato) has a very soft pericarp but drupe (Coconut) has stony endocarp.

Many ovaries of apocarpous gynoecium can form one fruit. Such fruits are **aggregate fruits**. Aggregate fruits are a collection (Etario) of many varieties. Accordingly they can be etario of achenes (Strawberry), etario berries (Custard apple), etario of follicles (*Calotropis*), etc.

Many ovaries of many flowers but of one inflorescence can form one fruit. Such fruits are **composite fruits**. These fruits develop from one inflorescence. The one which develops from hypanthodium inflorescence is syconus (fig). Sorosis (Pineapple) develops from Catkin inflorescence.

**G. Seed :** Seed is a reproductive unit that is developed from a fertilized, mature ovule. The

seed is composed of seed coat and embryo, with or without endosperm. Embryo contains radicle, plumule and one or two cotyledons. Outer most covering of a seed is called seed coat, shows outer layers called **testa** and inner **tegmen**. Hilum is a scar on the seed coat through which seed attaches to the fruit. Embryo of a seed enclosed within seed coat. Embryonal axis consists of **radicle** and **plumule**. The part of embryonal axis between cotyledon and plumule is **epicotyl**, while the part between cotyledons and radicle is **hypocotyl**. Endosperm formed in the seed is a nutritive tissue. The food stored in the endosperm is partially or completely used during embryo formation. When partially used up, the resultant seed is **endospermic** e.g. castor. When completely used up, the resultant seed is **non-endospermic** e.g. pea.

### 9.3 Study of some important families :

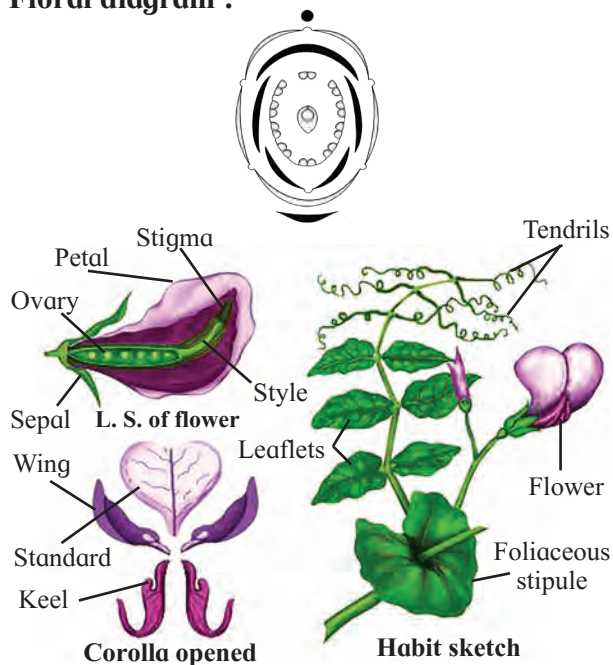
Families are group of plants having very distinguished common characters.

**Fabaceae :** The plants are either trees, shrubs or herbs. Pea plant belongs to this family. The root shows root nodules. Pea is an erect climber. The leaves are pinnately compound, arranged in alternate phyllotaxy. The inflorescence is racemose-raceme type. Flowers are bisexual and zygomorphic. Calyx has five fused sepals (gamosepalous) arranged in imbricate aestivation. Corolla has five free petals (polypetalous) arranged vexillary aestivation. The petals are unequal in size. The largest petal is vexillum, two free small petal are wings and two fused smallest petals are keel. Androecium has ten stamens arranged in

diadelphous [(g)+1] condition. Gynoecium is monocarpellary. Unilocular ovary is superior with many ovules on marginal placentation. Ovary develops in legume type of fruit. Seeds are non-endospermic.

**Floral formula :**  $\% \overset{\sigma}{\underset{\oplus}{\text{K}}}_{(5)} \text{C}_{1+2+(2)} \text{A}_{(9)+1} \underline{\text{G}}_1$

**Floral diagram :**



**Fig. 9.48** Pea plant details

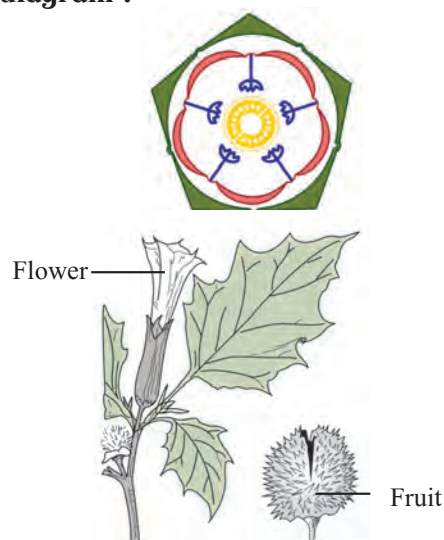
**Solanaceae :** Plants are herbs, shrubs or small trees. *Datura* plant belongs to this family. The root shows tap root system. The stem is erect, woody and branched. It is covered by hairy structures in some plants. In potato, it is underground tuber. The leaves

are simple, arranged in alternate phyllotaxy with reticulate venation. The inflorescence is Cymose- solitary type. Flowers are solitary, bisexual and actinomorphic. Calyx has five, fused sepals (gamosepalous) arranged in valvate aestivation and persistent. Corolla has five fused petals (gamopetalous) arranged in contorted aestivation. Androecium has five, free but epipetalous (adhesion) stamens. Gynoecium is bicarpellary and syncarpous.

Bilocular ovary is superior with many ovules arranged in axile placentation on swollen placenta. Ovary develops in berry or capsule type of fruit. Seeds are endospermic.

**Floral formula :**  $\oplus \overset{\sigma}{\underset{\oplus}{\text{K}}}_{(5)} \text{C}_{(5)} \text{A}_5 \underline{\text{G}}_{(2)}$

**Floral diagram :**



**Fig. 9.49** *Datura* plant



**Activity :**

Study family Liliaceae, prepare a table of following characteristics.

Character/Part	Description
Symmetry of flower	
Bisexual/Unisexual	
Calyx	
Corolla	
Androecium	
Gynoecium	
Aestivation	
a. Calyx	
b. Corolla	
Placentation	
Position of ovary	
Type of fruit	



## Exercise

### 1. Choose correct option

- A. Which one of the following will grow better in moist and shady region?
- Opuntia*
  - Orchid
  - Mangrove
  - Lotus*
- B. A particular plant had a pair of leaves at each node arranged in one plane. What is the arrangement called?
- Alternate phyllotaxy
  - Decussate phyllotaxy
  - Superposed phyllotaxy
  - Whorled phyllotaxy
- C. In a particular flower the insertion of floral whorls was in such a manner, so the ovary was below the level other three whorls, but its stigma was taller than other three whorls. What will you call such flower?
- Hypogynous
  - Perigynous
  - epigynous
  - Half superior - half inferior
- D. Beet and Arum both store food for perennation. Do these examples represent two different types?
- Beet is a stem but Arum is a root
  - Beet is a root but Arum is a stem
  - Beet is a stem but Arum is a leaf
  - Beet is a stem but Arum is an inflorescence

### 2. Answer the following questions

- A. Two of the vegetables we consume are nothing but leaf bases. Which are they?
- B. *Opuntia* has spines but *Carissa* has thorns. What is the difference?
- C. Teacher described *Hibiscus* as *solitary* Cyme. What it means?

### 3. Write notes on

- Fusiform root.
- Racemose inflorescence
- Fasciculated tuberous roots
- Region of cell maturation
- Rhizome
- Stolon
- Leaf venation
- Cymose inflorescence
- Perianth
- Vexillary aestivation
- Axile placentation

### 4. Identify the following figures and write down the types of leaves arrangement








### 5. Students were on the excursion to a botanical garden. They noted following observation. Will you be able to help them in understanding those conditions?

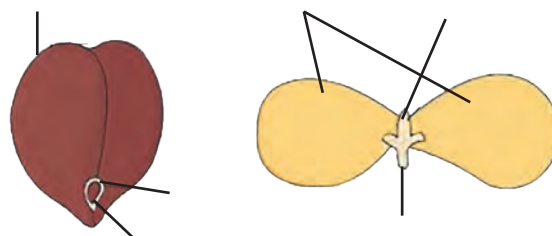
- A wiry outgrowth was seen on a plant arising from in between the leaf and stem.
- There was a green plant with flat stem, but no leaves. The entire plant was covered by soft spines.
- Many obliquely produced roots were given out from the lower nodes, apparently for extra support.
- Many plants in the marshy region had upwardly growing roots. They could be better seen during low tide.

- E. A plant had leaves with long leaf apex, which was curling around a support.
- F. A plant was found growing on other plant. Teacher said it is not a parasite. It exhibited two types of roots.
- G. While having lunch, onion slices were served to them. Teacher asked which part of the plant are you eating?
- H. Students observed large leaves of coconut and small leaves of *Mimosa*. Teacher asked it what way they are similar?
- I. Teacher showed them *Marigold* flower and said it is not one flower. What the teacher meant?
- J. Students cut open a Papaya fruit and found all the seeds attached to the sides. Teacher inquired about the possible placentation of Papaya ovary.

**6. Match the following**

	'Group A'	'Group B'
1		A Marginal
2		B Basal
3		C Axile
4		D Free central
5		E Parietal

**7. Observe the following figures and label the different parts**



**8. Differentiate with diagrammatic representation.**

- A. Racemose and cymose inflorescence
- B. Reticulate and parallel venation
- C. Tap root and Adventitious roots

**Practical / Project :**

1. Collect different leaves from nearby region and observe variation in margin, leaf base, apex etc.
2. Find out and make a note of economically important plant from family Fabaceae, Solanaceae and Liliaceae.
3. Collect different leaves from garden and observe their veins and classify it.

## 10. Animal Tissue



### Can you recall?

1. What is tissue?
2. Where is squamous epithelial tissue located?
3. Enlist functions of bone.



### Do you know ?

Number of cells in human body.

As we know tissue is a group of cells having same embryonic origin, structure and function. Various tissues combine together in an orderly manner to form large functional unit called organs. These organs combine together and form organ-system. The cells are of two types, somatic cells and germ cells. The word somatic is derived from the Greek word 'soma' means 'body'. All body cells of an organism except sperm and ova are somatic cells. The sperm and ova are germ cells. They belong to reproductive system.

Cells → Tissues → Organs → Organ systems → Body

**10.1 Histology :** The study of the structure and arrangement of tissue is called histology. There are four types of tissues present in animals namely epithelial, connective, muscular and nervous. Let us study each type in details.



### Know the scientist

Marie Francois Xavier Bichat (1771-1802), French anatomist and pathologist discovered tissue. He was known as 'Father of Histology'.



Marie Francois Xavier

### 10.2 Epithelial tissue (epi : above, thelium : layer of cells)

Epithelial tissue forms a covering on inner and outer surface of body and organs.

The cells of this tissue are compactly arranged with little intercellular matrix. Cells rest on non-cellular basement membrane.

Cells are polygonal, cuboidal or columnar in shape. Single nucleus is present at the centre or at the base. This tissue is avascular. It has good capacity of regeneration. Major function is protection and it also helps in absorption, transport, filtration and secretion. Epithelial tissue is classified into two types : Simple epithelium and Compound epithelium. Simple epithelium is made up of single layer of cells. Compound epithelium is made up of two or more layers of cells. Lowermost layer lies on basement membrane.

#### A. Simple epithelium :

**1. Squamous epithelial tissue :** Cells of this tissue are flat, thin, polygonal with serrated margin. Cells of this tissue fit together like tiles of footpath. Hence it is called pavement epithelium. Prominent spherical or oval nucleus is present at the centre of the cell. Function : Protection, absorption, transport, filtration, secretion. It is found in blood vessels, alveoli, coelom, etc.

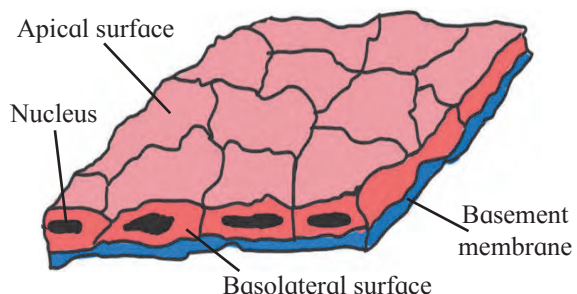
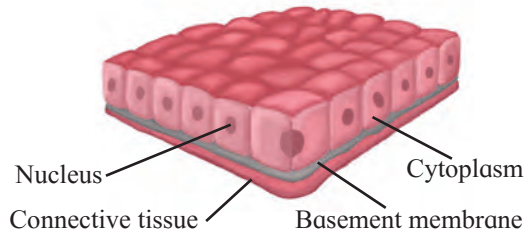


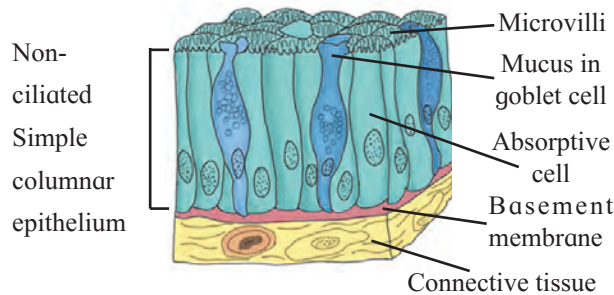
Fig. 10.1 Squamous epithelial tissue

**2. Cuboidal epithelium :** In this, the cells are cuboidal in shape with a spherical nucleus at the centre. Function : Absorption, secretion. It is found in lining of pancreatic duct, salivary duct, proximal and distal convoluted tubules of nephron.



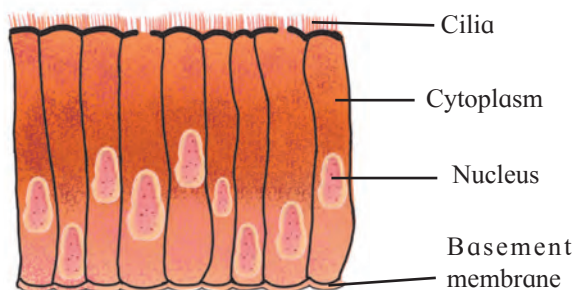
**Fig. 10.2 Cuboidal epithelium**

**3. Columnar epithelium :** Columnar epithelial cells are tall, pillar like. Inner ends of the cells are narrow while free ends are broad and flat. Free surface shows large number of microvilli. Nucleus is oval and is present in the lower half of the cell. Function : Secretion, absorption. It is found in inner lining of intestine, gall bladder, gastric glands, intestinal glands, etc.



**Fig. 10.3 Columnar epithelium**

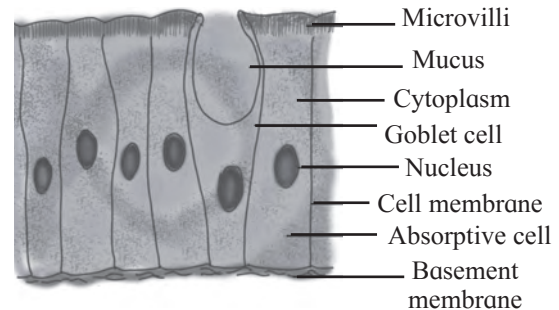
**4. Ciliated epithelium :** Cells of this tissue are cuboidal or columnar. Free ends of cells are broad while narrow ends rest on a basement membrane. Free ends show hair like cilia. Nucleus is oval and placed at basal end of cell. Function : To create a movement of materials in contact in a specific direction and thus able to prevent entry of foreign particles in the trachea, push the ovum through oviduct. It is found in inner lining of buccal cavity of frog, nasal cavity, trachea, oviduct of vertebrates, etc.



**Fig. 10.4 Ciliated epithelium**

**5. Glandular epithelium :** Here, the cells may be columnar, cuboidal or pyramidal in shape. Nucleus is large and situated towards the base. Secretory granules are present in the cytoplasm.

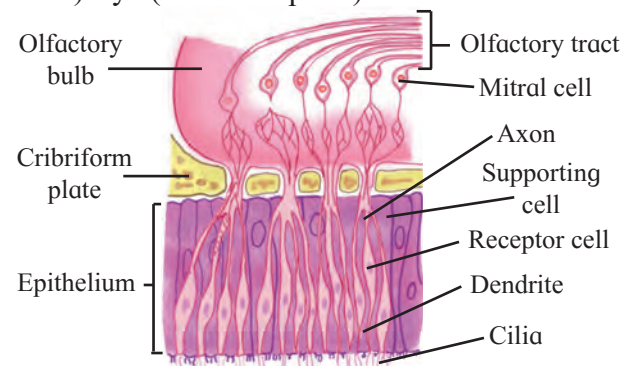
The glands may be unicellular (goblet cells of intestine) or multicellular (salivary gland) depending on the number of cells. Depending on mode of secretion, multicellular glands can be classified as duct bearing glands (exocrine glands) and ductless glands (endocrine glands).



**Fig. 10.5 Glandular epithelium**

Exocrine glands pour their secretions at a specific sites e.g. Salivary gland, sweat glands etc. Endocrine glands release their secretions directly into blood stream. e.g. thyroid gland, pituitary gland, etc. Function : Secrete the mucus that trap the dust particles, lubricates the inner surface of respiratory and digestive tracts, secretion of enzymes and hormones.

**6. Sensory epithelial tissue :** It is composed of modified form of columnar cells and elongated neurosensory cells. Sensory hairs are present at the free end of the cell. Function : It perceive external as well as internal stimuli. These are found in nose (Olfactory) Ear (Auditory hair cells) Eye (Photoreceptors).



**Fig. 10.6 Sensory epithelium**

**7. Germinal epithelium :** Cells of this epithelium divide meiotically to produce haploid gametes. Ex. : Lining of seminiferous tubules, inner lining of ovary.



**Use your brain power**

When do the transitional cells change their shape ?

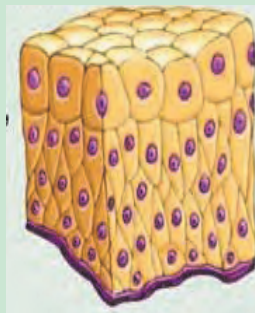
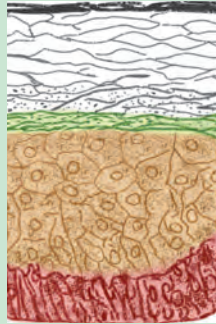
**B. Compound epithelium :**

**a. Stratified epithelium :**

Nucleus is present in stratum germinativum. Cells at free surface become flat and lack nucleus called stratum corneum.

Function : Protection

Ex. : Epidermis of skin, oesophagus cornea, vagina, rectum.



**b. Transitional epithelium:**

Structure of transitional epithelium is same like stratified epithelium. The cells can undergo a change in their shape and structure depending on degree of stretch.

Function : Distension of organ

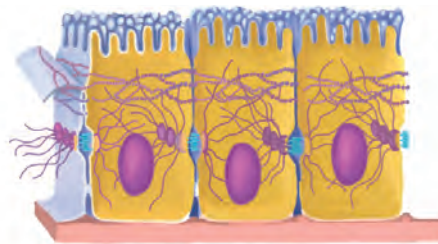
Ex. : Urinary bladder

**Fig. 10.7 Compound epithelial tissues**

**Cell junctions :** The epithelial cells are connected to each other laterally as well as to the basement membrane by junctional complexes called cell junctions.

**Tight junctions (TJs):**

These junctions maintain cell polarity, prevent lateral diffusion of proteins and ions.

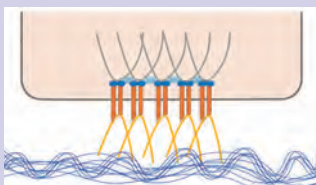


**Gap Junctions (GJs) :**

This intercellular connection allows passage of ions and small molecules between cells as well as exchange of chemical messages between cells.

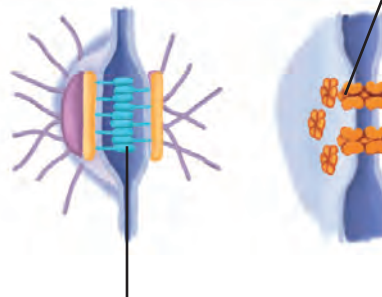
**Hemidesmosomes (HDs) :**

Allow the cells to strongly adhere to the underlying basement membrane. These maintain tissue homeostasis by signaling.



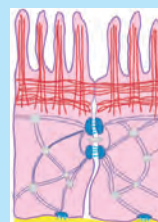
**Desmosomes (Ds) :**

These provide mechanical strength to epithelial tissue, cardiac muscles and meninges.



**Adherens Junctions (AJs) :**

It is involved in various signaling pathways and transcriptional regulations.



**Chart 10.8 Types of Cell junction :**





### Can you tell?

1. Explain basic structure of epithelial tissue and mention its types.
2. Epithelial tissue has good capacity of regeneration. Give reason.
3. Write a note on glandular epithelial tissue.
4. How do cell junctions help in functioning of epithelial tissue?

**10.3 Connective tissue :** It is most widely spread tissue in the body. It binds, supports and provides strength to other body tissues and organs. It consists of a variety of cells and fibres. These are embedded in the abundant intercellular substance called matrix. Connective tissue protects the vital organs of the body. It is highly vascular except cartilage. It acts as packing material and also helps in healing process.

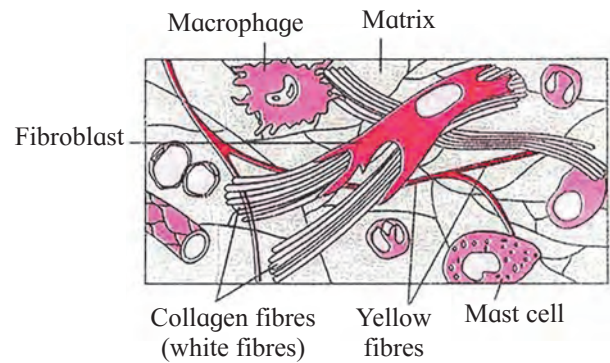
Connective tissue is classified on the basis of matrix present, as connective tissue proper, supporting connective tissue and fluid connective tissue. Connective tissue proper is further classified as loose connective tissue (ex. areolar connective tissue and adipose tissue) and dense connective tissue (ex. ligament and tendon). Supporting connective tissue also called skeletal tissue includes cartilage and bone. Fluid connective tissue includes blood and lymph.

#### A. Connective Tissue Proper

**Loose connective tissue :** Matrix of loose connective tissue is semisolid, jelly like, viscous matter made up of gelatin.

##### 1. Areolar tissue (Areola : air pockets):

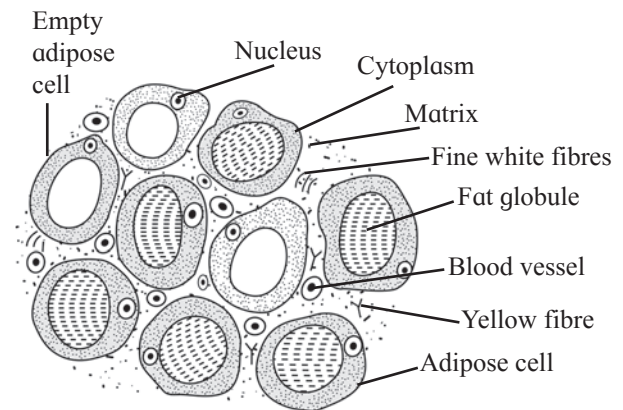
Matrix of this tissue contains two types of fibres namely white fibres and yellow fibres. White fibres are made up of collagen. They give tensile strength to the tissue. Yellow fibres are made up of elastin and are elastic in nature. The tissue also contains four different types of cells; fibroblast the large flat cells having branching processes.



**Fig. 10.9 Areolar tissue**

They produce fibres as well as polysaccharides that form the ground substance or matrix of the tissue. Mast cells are oval cells that secrete heparin and histamine. Macrophages are amoeboid, phagocytic cells. Fat cells, also called adipocytes have eccentric nucleus. These cells store fat. This tissue acts as packing material, helps in healing process and connects different organs or layers of tissues. It is found under the skin, between muscles, bones, around organs, blood vessels and peritoneum.

**2. Adipose tissue (Adipo : fat) :** In this tissue large number of adipocytes are present. Cells are rounded or polygonal. Nucleus is shifted to periphery because fats are stored in the cell in the form of droplets. Matrix is less and fibres and blood vessels are few in number.



**Fig. 10.10 Adipose tissue**

There are two types of adipose tissue : white adipose tissue appears opaque due to presence of large number of adipocytes. It is commonly seen in adults. Brown adipose tissue is reddish brown in colour due to presence of large number of blood vessels.

**Function :** Adipose tissue is a good insulator, acts as a shock absorber and a good source of energy because it stores fat. The tissue is found in sole and palm region as well as around organs like kidney.



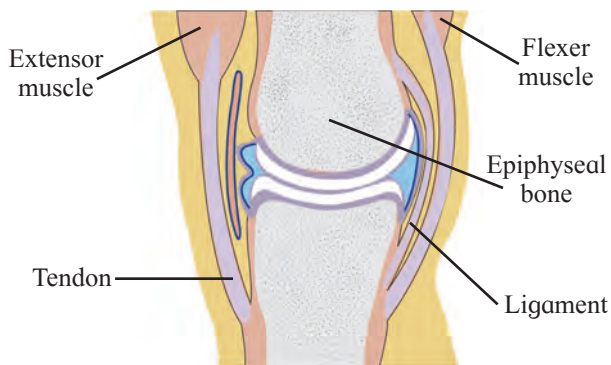
### Know your body

**Achilles Tendon :** Achilles Tendon connects the calf muscles to heel bone. Pain at the back of ankle or lower calf may signal a problem with an Achilles Tendon. Athletes who participate in track and field may face Achilles tendon injury. Most tendon injuries occur near joints such as the shoulder, elbow, knee and ankle.

### B. Dense Connective Tissue

In this tissue, fibres and fibroblasts are compactly arranged. There are two types, namely dense regular and dense irregular tissue.

In dense regular connective tissue, collagen fibres are arranged in parallel manner. Two major examples of this tissue are tendons and ligaments. Tendons connect skeletal muscles to bones. To give tensile strength to the tissue, tendons contain bundles of white fibres. E.g. Achilles tendon, Hamstring tendon.



**Fig. 10.11 Ligament**

Ligaments are made up of elastic or yellow fibres arranged in regular pattern. These fibres make ligaments elastic. They are present at joints. They prevent dislocation of bones.

In dense irregular connective tissue fibres and fibroblast are not arranged in orderly manner. This tissue is found in dermis of skin.

### C. Supporting Connective Tissue

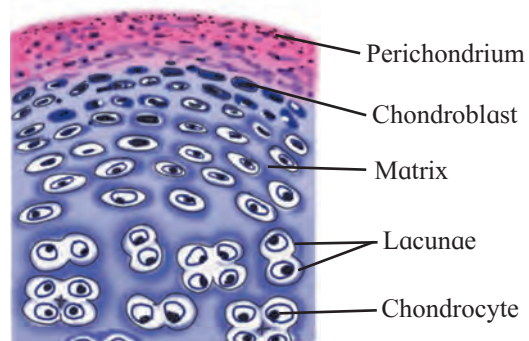
It is characterized by presence of hard matrix. It is classified into two types cartilage and bone.

**Cartilage :** This is a pliable yet tough tissue. It forms endoskeleton of cartilaginous fishes like shark. It is widely distributed in vertebrate animals. In cartilage, abundant matrix is delimited by a sheath of collagenous fibres called perichondrium. Matrix is called chondrin. Just below the perichondrium, immature cartilage forming cells called chondroblast are present. Chondroblasts mature and get converted into chondrocytes. Chondrocytes are seen scattered in the matrix. They are enclosed in lacunae. Each lacuna contains 2-8 chondrocytes.

Based upon the type of matrix, there are four types of cartilage as explained below.

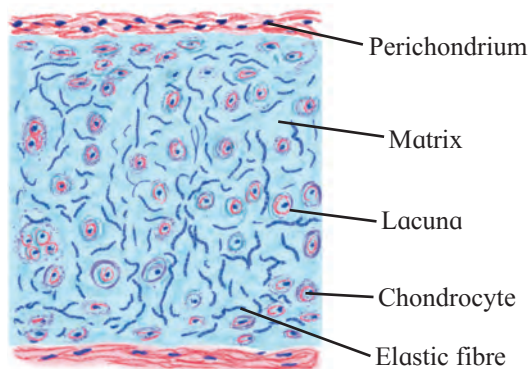
**Hyaline cartilage (Hyaline : Glass like) :** In this type of cartilage, perichondrium is present. Matrix is bluish white and gel like.

Very fine collagen fibres and chondrocytes are present. Hyaline cartilage is elastic and compressible in nature. It acts as a good shock absorber as well as provide flexibility. It reduces friction. It is found at the ends of long bones, epiglottis, trachea, ribs, larynx and hyoid.



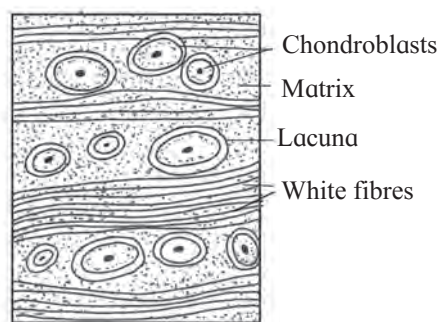
**Fig. 10.12 Hyaline Cartilage**

**Elastic cartilage :** In elastic cartilage perichondrium is present. Matrix contain elastic fibres. Chondrocytes are few in number. It gives support and maintains shape of the body part. It is found in ear lobe, tip of nose, etc.



**Fig. 10.13 Elastic cartilage**

**Fibrocartilage :** Perichondrium is absent in fibrocartilage. Matrix contains bundles of collagen fibres and few chondrocytes, scattered in fibres. Fibrocartilage is most rigid cartilage. It maintains position of vertebrae. Intervertebral discs are made up of fibrocartilage. It is also found at pubic symphysis.

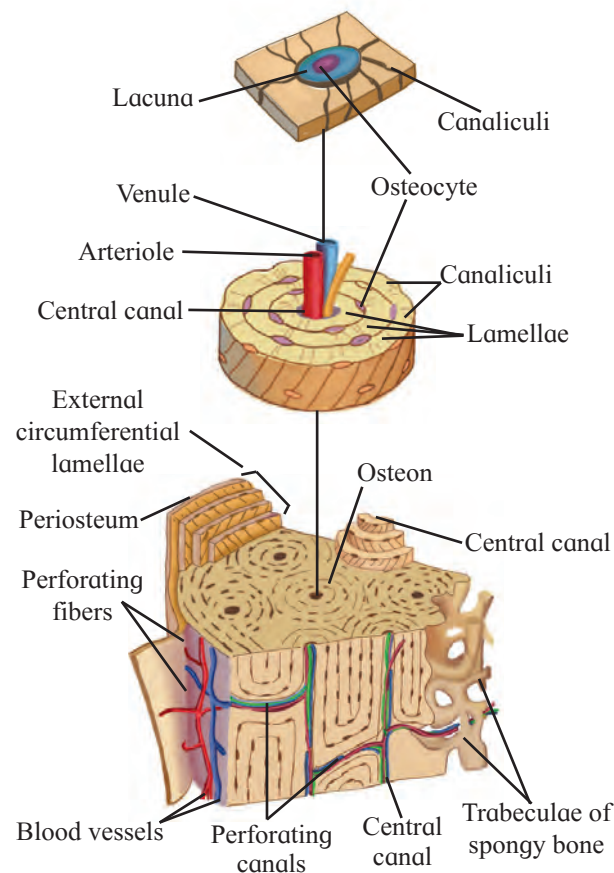


**Fig. 10.14 White fibrous cartilage**

**Calcified cartilage :** This type of cartilage becomes rigid due to deposition of salts in the matrix. This reduces flexibility of joints in old age e.g. Head of long bones.

**Bone :** Bone is characterised by hard matrix called Ossein. Ossein is made up of mineral salt hydroxy-apatite ( $\text{Ca}_{10}(\text{PO}_4)_6(\text{OH})_2$ ). Outer tough membrane called periosteum encloses the matrix. Blood vessels and nerves pierce through periosteum. Matrix is arranged in the form of concentric layers called lamellae.

Each lamella contains fluid filled cavities called lacunae. Fine canals that radiate from each lacuna are called canaliculi. Canaliculi of adjacent lamellae connect with each other as they traverse through the matrix. In the lacunae osteoblasts, active bone cells and osteocytes, the inactive bone cells and osteoclasts are present. Mammalian bone shows peculiar haversian system. Haversian canal encloses an artery, vein and nerves. Observe figure 10.15 to understand haversian system. According to presence of matrix there are two types of bones present in human body. In **spongy** bones, haversian system is absent. Reticular matrix is arranged in the form of trabeculae. It contains red bone marrow. In **compact** bones, matrix shows haversian system without any space between lamellae.



**Fig. 10.15 Bone detailed structure**



### Can you tell?

1. Give reason.
  - a. Bone is stronger than cartilage.
  - b. As we grow old, cartilage becomes rigid.
2. Explain histological structure of mammalian bone.

### D. Fluid Connective tissue (Vascular)

Blood and lymph are fluid connective tissue present in the body of an animal. You will study these tissues in details in chapter 'Circulation' in class XII.



### Can you recall?

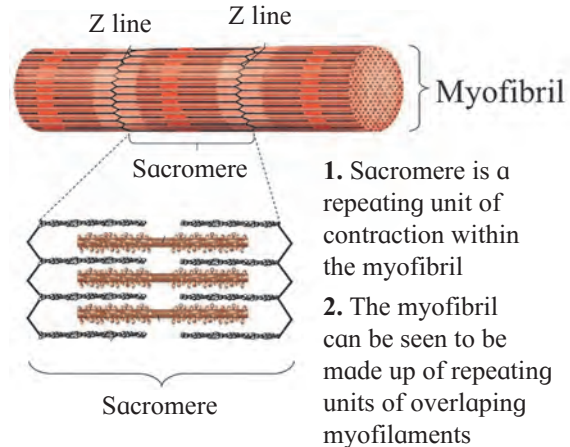
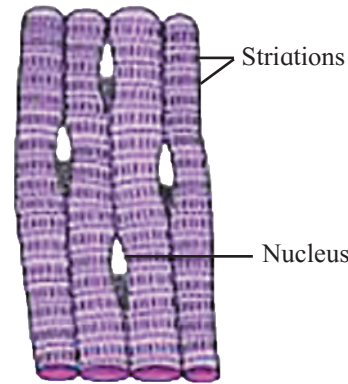
1. How many skeletal muscles are present in human body ?
2. How can exercise improve your muscular system ?

### 10.4 Muscular tissue :

The cells of this tissue are elongated and are called muscle fibres. Each muscle fibre is covered by a membrane sarcolemma. Cytoplasm of muscle cell is called sarcoplasm. Large number of contractile fibrils called myofibrils are present in sarcoplasm. One or many nuclei are present in muscle cell depending on the type. Myofibrils are made up of proteins, actin and myosin. Muscle fibres contract and decrease in length on stimulation. Hence, muscular tissue is known as contractile tissue. It is vascular tissue and is innervated by nerves too. Muscle cells contain large number of mitochondria.

### A. Types of Muscular Tissue

**1. Skeletal muscles :** These muscles are found attached to bones. Skeletal muscles consists of large number of fasciculi which are wrapped by connective tissue sheath called epimysium or fascia. Each individual fasciculus is covered by perimysium. Each fasciculus in turn consists of many muscle fibres called myofibres.



**Fig. 10.16 Muscular tissue**

Each muscle fibre is a syncytial fibre that contains several nuclei. The cell membrane called sarcolemma delimits the cytoplasm called sarcoplasm. Sarcoplasm contains large number of parallelly arranged myofibrils hence nuclei get shifted to periphery. Each myofibril is made up of repeated functional units called sarcomeres. Each sarcomere has a dark band called anisotropic or 'A' band in the centre. In the centre of 'A' band is light area called 'H' zone or 'Hensen's Zone'. In the centre of 'H' zone there is 'M' line. 'A' bands are made up of myosin as well as actin. On either side of 'A' band are light bands called isotropic or 'I' bands that contain only actin. Myosin are thick and dark coloured while actin filaments are thin and light coloured. Adjacent light bands are separated by 'Z' line (Z - Zwischenscheibe line). Dark and light bands on neighbouring myofibrils correspond with each other hence the muscle gets striated appearance.

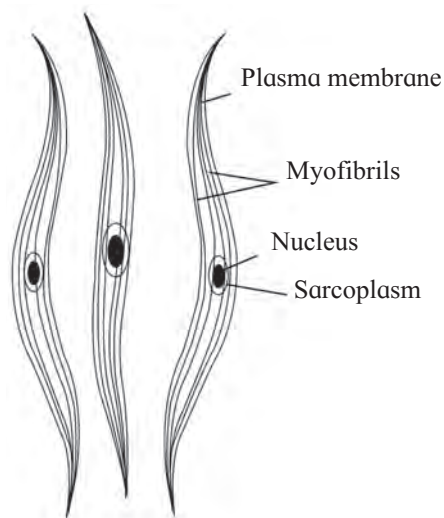
Skeletal muscles show quick and strong voluntary contractions. They bring about voluntary movements of the body. You will study about working of skeletal muscles in the chapter movement and locomotion.

**Red and white muscles :** On the basis of amount of a red pigment, skeletal muscles are of two main types – Red and white. Red muscles contain very high amount of myoglobin while white muscles contain very low amount of this pigment.

Myoglobin is an iron containing red coloured pigment only in muscles. It consists of one haeme and one polypeptide chain. It can carry one molecule of oxygen. Due to presence of myoglobin, the muscles can obtain their oxygen from two sources, myoglobin and haemoglobin.

## 2. Smooth or Non-striated muscles :

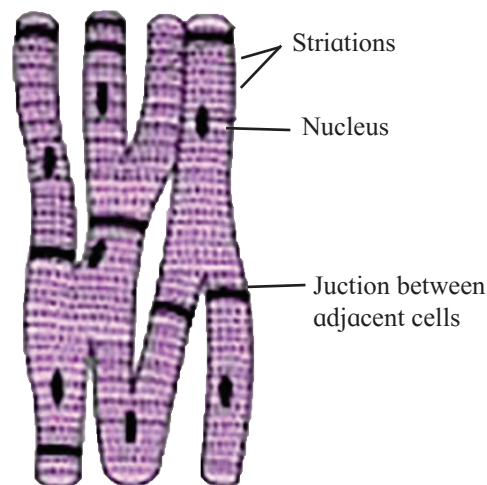
These muscles are present in the form of sheets or layers. Each muscle cell is spindle shaped or fusiform. The fibres are unbranched having single nucleus at the centre. Sarcoplasm contains myofibrils. Myofibrils are made up of contractile proteins actin and myosin. Smooth muscles contain less myosin and more actin as compared to skeletal muscles. Striations are absent. These muscles undergo slow and sustained involuntary contractions. They are innervated by autonomous nervous system.



**Fig. 10.17 Smooth muscle**

These are found in the walls of visceral organs and blood vessels. Hence they are also called as visceral muscles. They may be arranged lengthwise (longitudinal muscles) or around circumference (circular muscles) of any organ.

**3. Cardiac Muscles :** Muscles of this tissue show characters of both striated and non-striated fibres. Sarcolemma is not distinct. Hence uni-nucleate muscle fibres appear to be multi-nucleate. Adjacent muscle fibres join together to give branched appearance to the tissue. Points of adhesion of muscle fibres are formed by transverse thickenings of sarcolemma called intercalated discs.



**Fig. 10.18 Cardiac muscles**

These junctions at places allow cardiac muscles to contract as a unit. i.e. It helps in quick transfer of stimulus. The cardiac muscles are striated involuntary muscles.

Some mammalian cardiac muscles are modified and are capable of generating impulse on their own. Hence mammalian heart is a myogenic heart. In some animals, cardiac muscles need neural stimulus to initiate the contraction. Such a heart is called neurogenic heart. Cardiac muscles form myocardium of the heart wall.



### Can you tell?

Compare and contrast between various types of muscles.

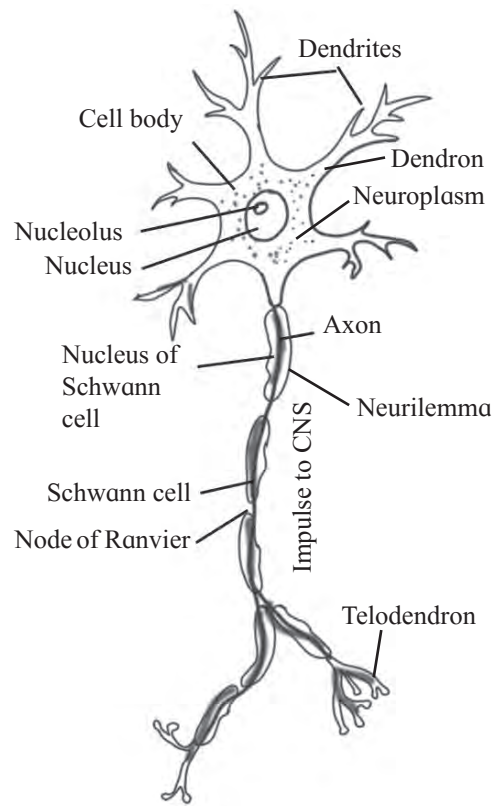
## B. Nervous Tissue :

Nervous tissue is composed of nerve cells or neurons and neuroglia. Neuron is the structural and functional unit of nervous system. Neuroglial cells are non-nervous supporting cells that fill in the interneuronal space. The neuroglial cells are capable of regeneration and division but neurons are not capable of regeneration because of lack of centriole. Intercellular matrix is absent in the neural tissue. Neuron is an impulse generating and impulse conducting unit. They bring about quick communication within the body. Neurons change action potential of their membrane on receiving any external stimulus. This property of neuron is called excitability. They also carry a wave of electric impulse from dendron to axon, the processes of neuron. This is called conductivity.

A **neuron** is made up of cyton or cell body. It contains granular cytoplasm called neuroplasm and centrally placed nucleus. Neuroplasm contains mitochondria, Golgi apparatus, RER and granules called Nissl's granules. They are made up of RNA. Cell body gives out two types of processes namely dendron and axon. Dendrons are short, branched, processes. The fine branches of dendron are called dendrites. They carry impulse towards cyton.

An axon is single, elongated, cylindrical process. Axon is bounded by axolemma. The protoplasm of the axon is axoplasm. It contains large number of mitochondria and neurofibrils. Axon is enclosed in a fatty sheath called myelin sheath. Outer covering of myelin sheath is neurilemma. Myelin sheath and neurilemma are parts of another cell called Schwann's cell. Schwann cell shows nucleus at periphery. The myelin sheath is absent at intervals along the axon and the place is called Node of Ranvier. The terminal arborization of an axon is called telodendron.

**Based on their functions, Neurons are classified into three types**



**Fig. 10.19 Structure of Multipolar Neuron**

**Afferent Neuron :** It carries impulses from sense organ to central nervous system (CNS). Hence it is also called sensory neuron. It is found in dorsal root of spinal cord.

**Efferent Neuron :** It carries impulses from CNS to effector organ. Hence it is also called motor neuron. It is found in ventral root of spinal cord.

**Interneuron or association neuron :** These are located between sensory and motor neurons. These perform processing, integration of sensory impulses and activate appropriate motor neuron to generate motor impulse.

Depending on the presence or absence of myelin sheath, neurons are classified into two types. i.e. myelinated and non-myelinated nerve fibre.

Myelinated or medullated nerve fibres have a insulating fatty layer called myelin sheath around the axon. This makes the fibre appear white in colour. This sheath is secreted by Schwann cells. The sheath is not continuous. It is interrupted at nodes of Ranvier. Neurilemma surrounds the axon.

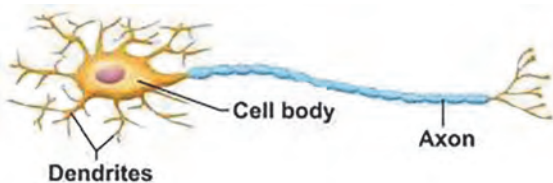
The impulse is conducted at a faster rate in such nerve fibres because it jumps from one node to the next. Such transmission of impulse is called saltatory conduction. Myelin sheath prevents the loss of the impulse during conduction. Cranial nerves of vertebrates are myelinated. Schwann cell of a non-medullated nerve fibre does not secrete myelin sheath. These fibres are grey in colour due to absence of fatty layer. Conduction of impulse in a non-myelinated fibre is slower as compared to myelinated nerve fibre. Nerves of autonomous nervous system are non-myelinated. Functional contact between axonal ends and dendrites of adjacent neurons is called a synapse. You will learn about synapse in chapter control and coordination, class-XII.

- 1. Unipolar/Monopolar Neuron :** It has a single process originating from cyton. Both axon and dendron arise from cyton at one point. They conduct impulses to central nervous system. Ex. Neurons of dorsal root ganglion of spinal nerve.
- 2. Bipolar Neuron :** It has two processes. A single dendron and an axon are given off from opposite poles of the cyton. They bring about transmission of special senses like sight, smell, taste, hearing etc. Ex. Neurons of retina of eye, olfactory epithelium.
- 3. Multipolar Neuron :** Cyton is star shaped and gives out more than two processes. There is only one axon and remaining are dendrons. Axon initiates from a funnel shaped area called axon-hillock.



### Internet my friend

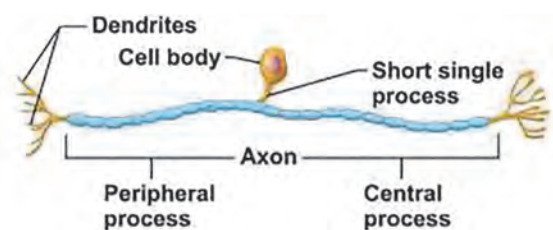
Learn about transmission of impulse from one neuron to another.



a. Multipolar neuron



b. Bipolar neuron



c. Unipolar neuron

**Fig. 10.19 Nervous tissue**

Based on the number of processes given out from cyton, neurons are classified into three types.



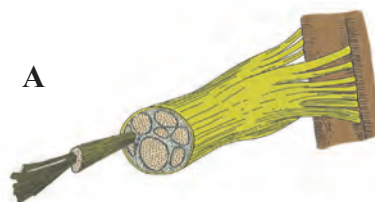
### Can you tell?

1. Differentiate between medullated and non medullated fibre.
2. Classify neuron on the basis of number of processes given out from cyton with examples.

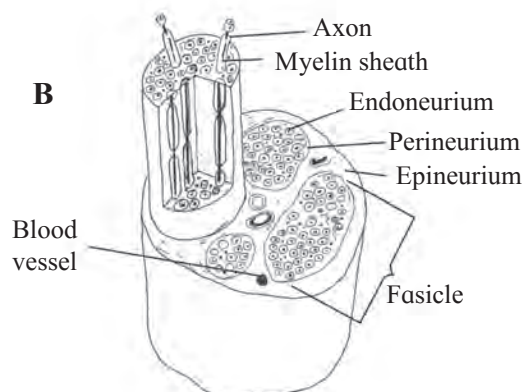


### Observe and Discuss

Explain the structure of nerve.



Covering of a spinal nerve





## Exercise

### 1. Choose correct option

- A. The study of structure and arrangement of tissue is called as \_\_\_\_\_  
 a. anatomy      b. histology  
 c. microbiology    d. morphology
- B. \_\_\_\_\_ is a gland which is both exocrine and endocrine.  
 a. Sebaceous    b. Mammary  
 c. Pancreas      d. Pituitary
- C. \_\_\_\_\_ cell junction is mediated by integrin.  
 a. Gap              b. Hemidesmosomes  
 c. Desmosomes    d. Adherens
- D. The protein found in cartilage is \_\_\_\_\_.  
 a. ossein          b. haemoglobin  
 c. chondrin        d. renin
- E. Find the odd one out  
 a. Thyroid gland    b. Pituitary gland  
 c. Adrenal gland    d. Salivary gland

### 2. Answer the following questions:

- A. Identify and name the type of tissues in the following:  
 a. Inner lining of the intestine  
 b. Heart wall  
 c. Skin  
 d. Nerve cord  
 e. Inner lining of the buccal cavity
- B. Why do animals in cold regions have a layer of fat below their skin?
- C. What enables the ear pinna to be folded and twisted while the nose tip can't be twisted?
- D. Sharad touched a hot plate by mistake and took away his hand quickly. Can you recognize the tissue and its type responsible for it?
- E. Priya got injured in an accident and hurt her long bone and later on she was also diagnosed with anaemia. What could be the probable reason?

- F. Supriya stepped out into the bright street from a cinema theatre. In response, her eye pupil shrunk. Identify the muscle responsible for the same.

### 3. Answer the following questions

- A. What is cell junction? Describe different types of cell junctions.
- B. With help of neat labelled diagram, describe the structure of areolar connective tissue.
- C. Describe the structure of multipolar neuron.
- D. Distinguish between smooth muscles and skeletal muscles.

### 4. Complete the following table

	Cell / Tissue / Muscles	Functions
1.	Cardiac muscles	-----
2.	-----	Connect skeletal muscles to bones.
3.	Chondroblast cells	-----
4.	-----	Secrete heparin and histamine

### 5. Match the following and rewrite:

#### 'A' Group

- Muscle
- Bone
- Nerve cell
- Cartilage

#### 'B' Group

- Perichondrium
- Sarcolemma
- Periosteum
- Neurilemma

### Practical / Project :

- To study the different tissues with the help of permanent slides in your college laboratory.
- Collect the information about the exercise to keep muscles healthy and strong.



## 11. Study of Animal Type - Cockroach



### Can you recall?

1. How many different types of animals are present around us?
2. Can a person complete detailed study of each of those animals?
3. Which phylum is most diverse and populous?

### 11.1 Habit and habitat :

Cockroaches are omnipresent i.e. present everywhere, all over the world. It prefers damp and moist places, crevices to live. It is omnivorous, nocturnal and cursorial.

*Periplaneta americana*, *Blatta orientalis* and *Blatta germanica* are the three common species of cockroach found in India.

### 11.2 Systematic Position :

**Kingdom :** Animalia (Cell wall absent, heterotrophic nutrition.)

**Phylum :** Arthropoda (Jointed appendages are present, segmented body, chitinous exoskeleton.)

**Class :** Insecta (Two pairs of wings and three pairs of walking legs are present.)

**Genus :** *Periplaneta* (Nocturnal, straight wings.)

**Species :** *americana* (Origin is in Continent of America)

### Curiosity box:

1. Why do insects need moulting?
2. What is the difference between simple and compound eyes?

### 11.3 External morphology :

**Shape and size :** Cockroach has an elongated, bilaterally symmetrical and dorso-ventrally flattened body. They are triploblastic, eucoelomate and truly segmented animals. Body cavity is called as haemocoel, filled with haemolymph.

**Coloration :** Cockroach is glistening brown or red brown in colour.

**Exoskeleton :** Body of cockroach is protected by hard, waxy, tough, non-living exoskeleton. Exoskeleton is formed by a nitrogenous polysaccharide-chitin that provides strength, elasticity and surface area for attachment of muscles. Each body segment of cockroach is covered by four chitinous plates (sclerites) namely, dorsal tergum, ventral sternum and two lateral pleurons.

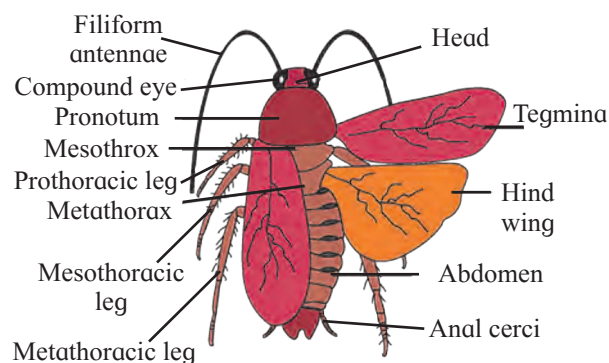


Fig. 11.1 Dorsal view

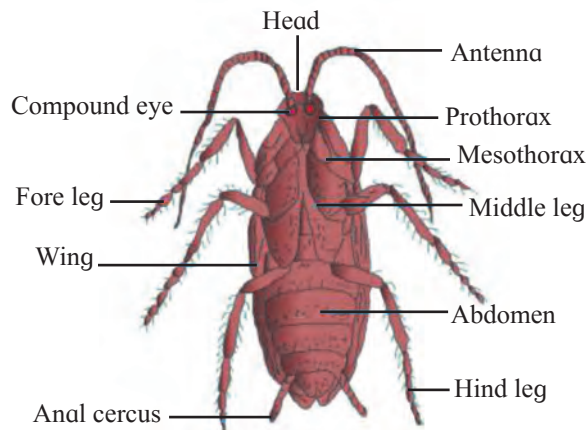
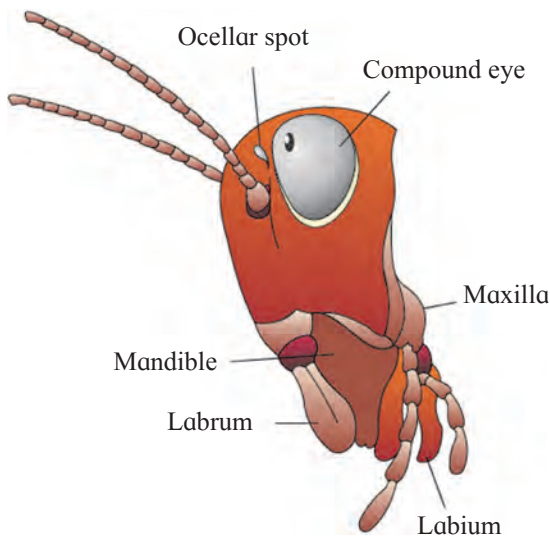


Fig. 11.2 Ventral view

**Body Division :** Body is divided into three regions namely head, thorax and abdomen. Head is attached at right angles to thorax by a thin, narrow, movable neck or cervix.

**Head :** It is formed by the fusion of six segments. It is triangular or ovate in shape. It is highly mobile due to flexible neck. It bears a pair of long antennae, a pair of compound eyes and mouth parts adapted for chewing and biting of food.



**Fig. 11.3 Head**

**1. Antennae :** Also called as feelers. There are filamentous, long, segmented structures that can be moved in all directions. They are lodged in membranous pits called antennal sockets. They are tactile (touch) as well as olfactory (smell) organs, useful in locating the food material in the vicinity.

**2. Fenestrae** are also called as ocellar spots situated at the base of each antenna and they appear as white spots.

**3. Compound eyes :** They are paired, dark, kidney shaped structures placed on lateral sides of the head and are made up of large number of ommatidia (singular ommatidium). **Ommatidia** are structural and functional units of compound eye, each forming an image of very small part of visual field. Collectively, compound eye produces a mosaic image.

**4. Mouth parts :** Cockroach has pre-oral cavity in front of mouth in which food is received. It is bounded by chewing and biting type of mouth parts. These are movable, segmented appendages which assist in ingestion of food. Mouth parts of cockroach comprise of...

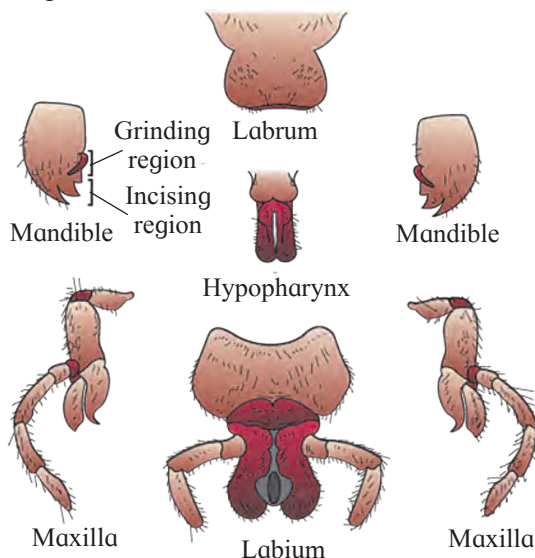
**i. Labrum (Upper lip) :** It is single flap-like movable part which covers the mouth from upper side. It forms an anterior wall of pre-oral cavity. It is useful in holding of the food during feeding.

**ii. Mandibles (True jaws) :** These are two dark, hard, chitinous structures with serrated median margins. They are present on either side, behind the labrum. They perform coordinated side-wise movements to cut and crush the food. This movement is effected with the help of adductor and abductor muscles

**iii. Maxillae (Accessory jaws) :** These are also called as first pair of maxillae. These are situated on the either side of mouth behind the mandibles. Each maxilla consist of sclerites like cardo, stipes, galea, lacinia and maxillary palps. Maxillary palps act as tactile organs. The maxillae hold food, help the mandibles for mastication. Maxillae are also used for cleaning the antennae and front legs.

**iv. Labium (lower lip) :** It is also called as second maxilla which covers the pre-oral cavity from ventral side and is firmly attached to the posterior part of head. It has labial palps which is three jointed and sensory in function. It is useful in pushing the chewed food in the pre-oral cavity and also prevents the loss of food falling from the mandibles during the chewing.

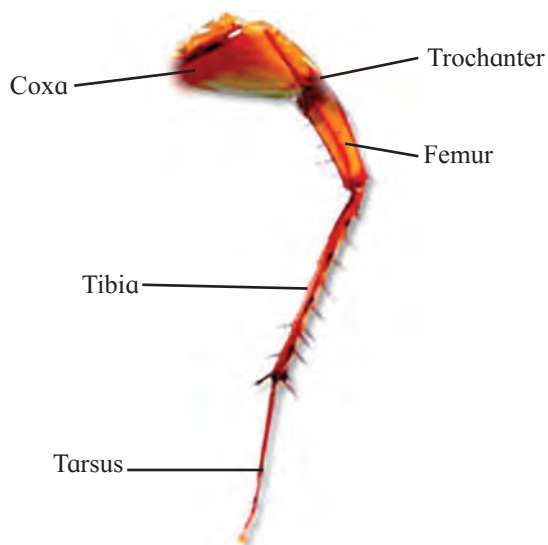
**v. Hypopharynx (Tongue) :** In front of the labium and between first maxillae, there is a some what cylindrical single structure called hypopharynx or lingua. A salivary duct opens at the base of this structure. Lingua bears comb-like plates called super-lingua on either side. It is useful in the process of feeding and mixing of saliva with food.



**Fig. 11.4 Mouth parts**

**Thorax :** Thorax is three segmented. Anterior segment is prothorax, middle mesothorax and posterior metathorax. Thorax bears three pairs of walking legs ventrally (one at each segment) and two pairs of wings dorsally (attached to mesothoracic and metathoracic segment).

**Legs :** Three pairs of walking legs are present on ventral side. Each leg has five podomeres namely coxa, trochanter, femur, tibia and tarsus. Tarsus is the last segment and is made up of five movable segments or tarsomeres. Last tarsomere bears a pair of claws and cushion-like arolium helpful in clinging.



**Fig. 11.5 Leg of cockroach**

**Wings :** Two pairs of wings as forewings and hindwings are present on dorsal side. Forewings are first pair of dark, opaque, thick, leathery wings which are protective in function. Hindwings are thin, broad, membranous, delicate and transparent. These are attached to tergum of metathorax. These are helpful in flight and hence are also called as true wings.

**Spiracles :** These are a series of slit-like openings on either side the body. In all, there are ten pairs - two on thorax and eight on abdomen. The spiracles let the air into and out of the tubes called trachea.

**Abdomen :** The abdomen is elongated and made up of ten segments. Each segment has a dorsal tergum and ventral sternum.

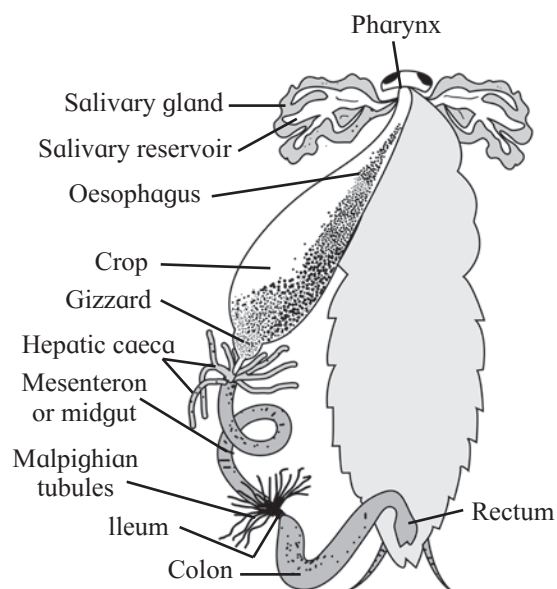
Laterally, tergum is jointed to sternum by soft cuticle called pleura. The posterior segments are telescoped in. Due to this, eighth and ninth terga get overlapped by the seventh. The tenth tergum projects backward. It is deeply notched. The tenth tergum also bears a pair of small, many jointed anal cerci. In the male, the abdomen is narrow and tapering than that in female. In male, the ninth sternum also bears a pair of short, unjointed anal style.

**11.4 Body cavity :** A body cavity or true coelom is present around the viscera. Because of the open type of circulation, the body cavity is filled up with blood. Hence, it is called haemocoel. In the haemocoel, fat bodies are seen. It is in the form of loose, whitish mass of tissue. The fat body is made up of large, polygonal cells which contain fat globules, proteins and sometimes glycogen.

#### 11.5 Digestive system of cockroach :

Digestive system of cockroach consists of mouth parts, alimentary canal and a pair of salivary glands.

Alimentary canal is a long (6-7 cm) tube of different diameters and with two openings. Alimentary canal is divisible into three regions as Foregut (stomodaeum), Mid-gut (mesenteron) and Hindgut (proctodaeum).



**Fig. 11.6 Digestive system of Cockroach**

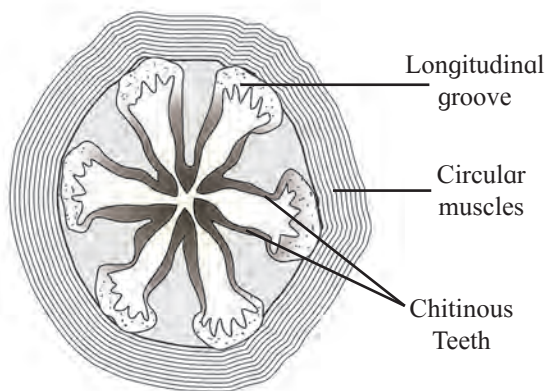
**Mouth :** Mouth / pre-oral chamber is a narrow space bounded by mouth parts. Hypopharynx is present at the centre of mouth. Salivary duct opens at the base of hypopharynx. Mouth opens into foregut.

**Fore-gut (Stomodaeum) :**

Foregut consists of pharynx, oesophagus, crop and gizzard. Pharynx is very short, narrow but muscular tube. It contains taste sensillae. It leads to oesophagus.

Oesophagus is slightly long and narrow tube. It opens in crop. Crop is large, pear-shaped sac like organ. It temporarily stores the food and then sends it to gizzard.

Gizzard (Proventriculus) is small, spherical organ. Internally, it is provided with a cirlet of six chitinous teeth and backwardly directed bristles. Teeth are responsible for crushing the food. Bristles help in filtering the food. Foregut ends with gizzard.



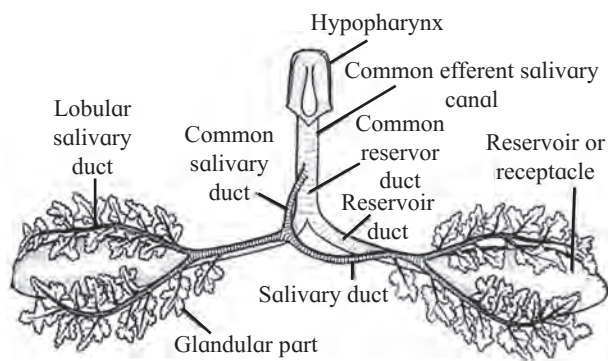
**Fig. 11.7 T. S. of Gizzard**

**Mid-gut (Mesenteron) :** Midgut consists of stomach and hepatic caecae. Stomach (**ventriculus**) is straight, short and narrow. It is lined by glandular epithelium. Which secretes digestive enzymes. Hence, stomach is mainly responsible for digestion and absorption. Hepatic caecae are thin, transparent, short, blind (closed) and hollow tubules. Hepatic caecae secrete digestive enzymes and thus help in digestion of food.

**Hind-gut (Proctodaeum) :** Hindgut consists of **ileum, colon** and **rectum**. Ileum is short and narrow part of hind-gut. Malpighian tubules open in the anterior lumen of ileum, near the junction of mid-gut with hind-gut. Posterior region of ileum contains sphincter. Ileum sends nitrogenous wastes and undigested food towards colon.

Colon is longer and wider part of hind-gut. It sends the waste material towards rectum. It reabsorbs water from wastes as per need. Rectum is oval or spindle-shaped, terminal part of hind-gut. It contains six rectal pads along internal surface for absorption of water. Rectum opens outside by anus. Anus is present on ventral side of 10<sup>th</sup> segment. Anus is last/posterior opening of digestive system. It gives out undigested food.

**Salivary Glands :** Cockroach has a pair of salivary glands which secrete saliva. Each gland consists of two glandular lobes and one receptacle or reservoir. Glandular lobes consists of many irregular-shaped white lobules. These lobules secrete saliva. Each gland has a salivary duct. Both ducts unite together to form a common salivary duct. Receptacle of each gland is thin-walled, elongated, sac-like structure. Each receptacle has a duct. These ducts unite to form common reservoir duct. Both common ducts i.e. common salivary duct and common reservoir duct unite together to form common efferent salivary duct. Efferent salivary duct opens at the base of tongue or hypopharynx.



**Fig. 11.10 Salivary glands of Cockroach**

**Food and digestion :** Cockroach is omnivorous. It feeds upon plant and animal material. It has chewing and biting type of mouth parts, that chew the food and push it into alimentary canal. As food passes through the alimentary canal, it is digested and finally undigested food is eliminated through anus.



### Do you know?

Cockroaches eat young cockroach. Such tendency is called Cannibalism.

## 11.6 Circulatory system or blood vascular system:

Cockroach has open type of circulatory system that consists of colourless blood (haemolymph), a dorsal blood vessel (heart and dorsal aorta) and haemocoel.

**A. Haemolymph :** Haemolymph of cockroach is without any pigment; hence it is colourless. It consists of plasma and seven types of blood cells / haemocytes. Plasma consists of water with some dissolved organic and inorganic solutes. It is rich in nutrients and nitrogenous wastes like uric acid.



### Use your brain power

Why body cavity of cockroach is called as haemocoel?

**B. Haemocoel :** Body cavity (coelom) of cockroach is divided into three sinuses due to two diaphragms i.e. dorsal and ventral diaphragm.

Dorsal and ventral diaphragms are thin fibromuscular septa (sing.—septum). It remains attached to terga along lateral sides at intermittent points.

Dorsal diaphragm has 12 pairs (2 thoracic and 10 abdominal) of fan like alary muscles. Alary muscles are triangular with pointed end attached to terga at lateral side and broad end lies between heart and dorsal diaphragm. Ventral diaphragm is flat and present just above the ventral nerve cord. Laterally, it is attached to sterna at intermittent points.

**Sinuses :** Coelom of cockroach is gets divided into three sinuses as pericardial, perivisceral and perineural sinus. Pericardial sinus is dorsal, very small and contains dorsal vessel. Perivisceral sinus is middle and largest. It contains fat bodies and almost all major visceral organs of alimentary canal and reproductive system. Perineural sinus is ventral, small and contains ventral nerve cord. It is continuous into legs. All the three sinuses communicate with each other through pores present between two successive points of attachments of diaphragms.

**Dorsal blood vessel :** This is present in pericardial sinus, just below the tergum. It is divisible into posterior heart and anterior aorta (dorsal aorta / cephalic vessel). Heart is about 2.5cm long, narrow, muscular tube that is open anteriorly and closed posteriorly. It starts from 9<sup>th</sup> abdominal segment and extends anteriorly upto 1<sup>st</sup> thoracic segment. It is divisible into thirteen chambers. Ten chambers are in abdominal region and three are in thoracic region. Each chamber has a pair of vertical slit like incurrent aperture / opening called ostium (pl. - ostia). Ostia are present along lateral side in posterior region of first 12 chambers.

Each ostium has lip-like valves that allow flow of blood from sinus to heart only. Heart is continued by a short, thin walled vessel called as dorsal aorta. It lies in head region and opens in the haemocoel.

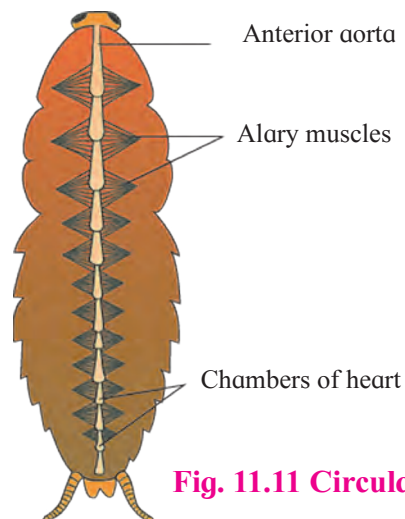


Fig. 11.11 Circulatory System

### Blood circulation in cockroach :

Blood circulates between sinuses and heart due to contraction and relaxation of heart and alary muscles. Heart alternately contracts (systole) and relaxes (diastole). After diastole, there is a third phase in the heart cycle known as diastasis. Heart remains in expanded state during diastasis.

During diastole, alary muscles contract, making the dorsal diaphragm flat. As a result blood passes from perivisceral to pericardial sinus through fenestrae and finally to the heart through ostia. During systole, contraction starts at posterior end and wave of contraction passes anteriorly. Due to this, blood is pushed towards cephalic vessel i.e. dorsal aorta. During systole, ostia remain closed with the help of valves. As a result of systole, blood is flushed into head region from where it goes to perivisceral and perineural sinus.

Alary muscles are relaxed during systole. Due to this, dorsal diaphragm becomes convex, reducing the volume of pericardial sinus. This makes the blood to move from pericardial sinus to perivisceral sinus through fenestrae.

### 11.7 Respiratory system or tracheal system :

Cockroach has an internal respiratory system of air tubes called tracheal system, by which air is brought into the body and is in contact with every part of body. It allows exchange of gases directly between the air and tissues without the need of blood.

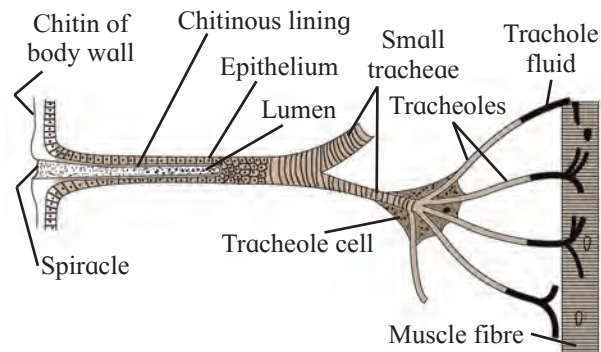


Fig. 11.12 Respiratory System

**Spiracles :** Spiracles are respiratory openings. They are paired, present on ventro-lateral side of body, in pleural membrane. Cockroaches have two pairs of thoracic and eight pairs of abdominal spiracles. The spiracles open into a series of air sacs from which the tubes called trachea arise.

**Trachea :** The trachea form a definite pattern of branching tubes arranged transversely as well as longitudinally. They are about 1mm thick and have spiral or annular thickening of chitin. The inner lining of chitin prevents the trachea from collapsing. Each trachea branches into number of smaller tubes called tracheoles.

**Tracheole :** These are fine intracellular tubes that penetrate deep into tissues. They are thin and not lined with chitin. They end blindly in the cells. Each tracheole at the blind end is filled with a watery fluid through which exchange of gases takes place. The content of this fluid keeps changing. At high muscular activity, a part of fluid is drawn into the tissues to enable more and rapid oxygen intake. The rhythmic movements of thoracic and abdominal muscles renew the air in the tracheal system. The body fluid does not distribute the gases but simply acts as a stationary medium for diffusion.

### 11.8 Excretory System :

Malpighian tubules are main excretory organs of cockroach. They are attached to the alimentary canal between the midgut and hindgut. They are thin, yellow coloured, ectodermal thread-like structures hanging freely in the haemocoel. They are about 150 in number.

**Malpighian Tubule :** Each Malpighian tubule is lined with a single layer of glandular epithelial cells having microvilli. Their distal portion is secretory and proximal part is absorptive in function. They extract water and nitrogenous wastes from the haemocoel and convert them into uric acid and pass them into ileum. As the cockroach excretes uric acid, it is said to be uricotelic. In addition, the fat bodies, nephrocytes and uricose glands (in male cockroach only) also help in excretion.

In cockroach, urate cells (nephrocytes) associated with fat bodies and cuticle are also believed to be excretory in function. The nephrocytes are cells present along with the fat bodies or present along the heart and store nitrogenous wastes. The excretory products later are removed in the haemocoel. Some nitrogenous wastes are deposited on the cuticle and eliminated during moulting.

### 11.9 Nervous system :

The nervous system of cockroach consists of Central Nervous System (CNS), Peripheral Nervous System (PNS), and Autonomus Nervous System (ANS). Nervous system of cockroach is ventral, solid and ganglionated.

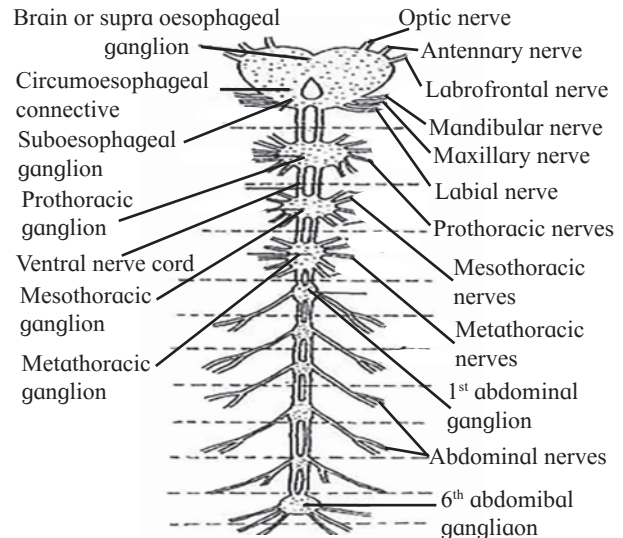
#### A. Central Nervous System (CNS):

CNS consists of nerve ring and ventral nerve cord. **Nerve ring** is made up of supra-oesophageal ganglia, circum-oesophageal connective and sub-oesophageal ganglion. A pair of supra-oesophageal / cerebral ganglia is collectively known as brain. Brain is present in head, above the oesophagus and between antennal bases. Each cerebral ganglion is formed by fusion of three small ganglia- protocerebrum, deutocerebrum and tritocerebrum.

Sub-oesophageal ganglion is bilobed; present below the oesophagus in head. It is also formed by fusion of 3 pairs of ganglia.

Cerebral ganglia are connected to sub-oesophageal ganglion by a pair of lateral nerves called as circum-oesophageal connectives. Connectives arise from cerebral ganglia.

**Ventral nerve cord (VNC) :** It arises from sub-oesophageal ganglion. It is present along mid-ventral position, in perineural sinus. It is double nerve cord and consists of nine segmental, paired ganglia. First three pairs of segmental ganglia are large and known as thoracic ganglia. Six pairs of segmental ganglia are in abdomen. Sixth abdominal ganglion is largest and it is present in 7<sup>th</sup> abdominal segment. There is no ganglion in 6<sup>th</sup> segment.



**Fig. 11.13 Central Nervous System**

#### B. Peripheral Nervous System (PNS):

Peripheral nervous system consists of nerves arising from various ganglia of CNS. Six pairs of nerves arise from cerebral ganglia. They go to eyes, antennae and labrum. Nerves arising from sub-oesophageal ganglion go to mandibles, maxillae and labium. Nerves arising from thoracic ganglia go to the wings, legs and internal thoracic organs. Nerves from abdominal ganglia go to the abdominal organs of respective abdominal segments.

#### C. Autonomus Nervous System (ANS):

It consists of four ganglia and a retrocerebral complex. These ganglia are as follows.

- 1. Frontal ganglion :** It is present above the pharynx and in front of brain.
- 2. Hypocerebral ganglion :** It is present on the anterior region of oesophagus.
- 3. Inguivial ganglion :** It is present on crop. It is also called as visceral ganglion.
- 4. Ventricular ganglion :** It is present on gizzard.

#### Sense organs :

**Collect the information and complete the chart:**

Sense Organ	Location	Function
1. Antennae		
2. Eyes		
3. Maxillary palp		
4. Labial palp		
5. Anal Cerci		

**Knowledge Enhancer :** Compound eyes are present in the cockroach, situated on the dorsal surface of the head. Each eye consists of about 2000 hexagonal ommatidia (singular : Ommatidium). Each ommatidium is like a simple eye, forming image independently, hence with the help of several ommatidia, a cockroach receives several images of an object. Compound eye gives mosaic or hazy vision, but the animal is able to detect even a slightest movement of the object. This kind of vision is with more sensitivity but less resolution.

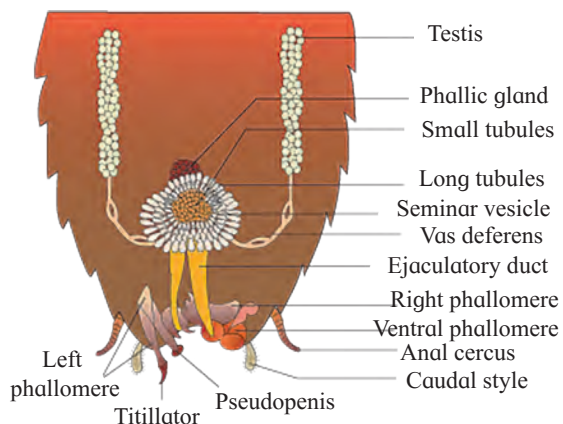
### 11.10 Reproduction system :

Cockroach is dioecious organism i.e. male and female individuals are separate.

**1. Male Reproductive System :** Male reproductive system consists of primary and secondary reproductive organs. Primary sex organs (male gonads) are called testes which are paired and located in the 4<sup>th</sup> to 6<sup>th</sup> abdominal segments. They produce sperms which are carried by vasa deferentia. It is a pair of thin tubular structure arising from the testes and opening into the ejaculatory duct through seminal vesicle. They carry sperms to the ejaculatory duct. Ejaculatory duct opens into male gonopore situated ventral to anus.

Mushroom shaped gland or Utricular gland is accessory reproductive gland. It is present in the 6<sup>th</sup> to 7<sup>th</sup> abdominal segments.

Male gonapophyses or phallomere are external genitalia of male. These are three asymmetrical chitinous structures surrounding the male gonophore.



**Fig. 11.14 Male Reproductive System**

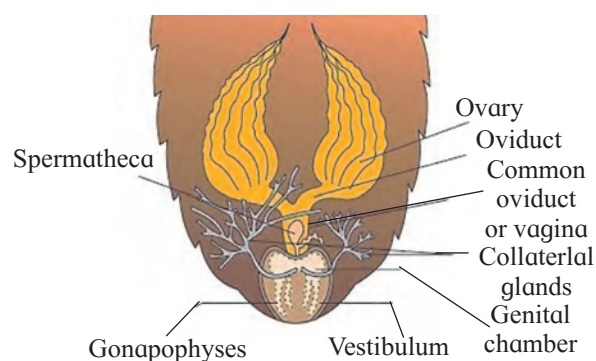
The sperms produced by the testes are stored in seminal vesicles and are glued together in the form of bundles called spermatophores. These spermatophores are deposited in female reproductive tract during copulation.

**2. Female Reproductive System :** Female reproductive system consists of primary and secondary reproductive organs. Primary reproductive organs are ovaries. There is a pair of large ovaries, lying laterally in the 2<sup>nd</sup> to 6<sup>th</sup> abdominal segments. Each ovary is formed of a group of 8 ovarian tubules or ovarioles, containing a chain of developing ova.

All ovarioles of an ovary open in lateral oviduct of respective side. Both lateral oviducts unite to form common oviduct or vagina. Common oviduct or vagina opens into the genital chamber (bursa copulatrix), the female organ of copulation.

A sperm storing structure called spermatheca is present in the 6<sup>th</sup> segment that open into the genital chamber. Besides, paired accessory glands-collateral glands are also present that open in genital chamber.

Female gonapophyses consist of six chitinous plates surrounding the genital pore.



**Fig. 11.15 Female Reproductive System**

### Fertilization and formation of ootheca :

Male and female cockroaches come together by their posterior ends and with the help of phallomeres. The spermatophores are transferred to the genital chamber of female cockroach.



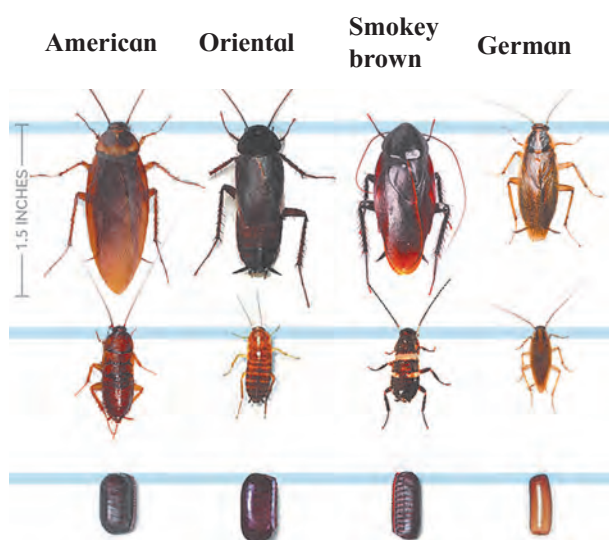
The sperms are released from spermatophore and they reach the spermatheca. The eggs are discharged from both the ovaries alternately into the common oviduct and pass into the genital chamber where they are fertilized by the sperms coming from the spermatheca. The process of fertilization is internal.

**Ootheca :** The secretion of collateral glands forms a capsule around them is called as ootheca or egg case. Ootheca is dark reddish to blackish brown capsule about 8 mm long, containing 14 to 16 fertilized eggs in two rows. Ootheca are dropped or glued to a suitable surface like a crack or crevice of good humidity near the food source. On an average, a female produces 9 to 10 oothecae.

**Development of Eggs :** The development of *Periplaneta americana* is paurometabolous i.e. there is development through nymphal stage. Embryonic period varies as per temperature and humidity. At 24°C, duration is about 58 days and at 30°C, the duration is about 32 days.

**Fertilized egg → Nymph → Adult**

The nymph looks like the adult but far smaller and is sexually immature. After sufficient growth, nymph undergoes moulting and enters into next instar (a stage between two successive moults).



**Fig. 11.16 Cockroach Development stages**

Cockroach may undergo moulting for about 13 times before reaching the adult stage. The nymphal stages have wing pads but only adult cockroaches have wings.

### 11.11 Interactions with mankind :

1. Cockroach causes damage to the household materials like clothes, shoes, paper etc. They also eat and destroy the food stuff.
2. They contaminate food which gives typical smell and make it unpalatable.
3. As they live in sewage pipes and gutter holes, they carry with them harmful pathogens causing diseases like cholera, diarrhoea, tuberculosis, typhoid, etc.
4. Cockroach serves as a part of food chain also. Many amphibians, birds, lizards and rodents prey upon them making them a part of food chain. They are eaten by certain groups of people in South America, China and Myanmar.
5. Cockroach is used as experimental animal in laboratories and for biological research, as they can be obtained easily without causing damage to ecological balance.

**Control Measures :** As cockroach is economically harmful organism it must be controlled in an efficient way. Some of the measures are as follows :

**1. Good Sanitation :** Dark and humid places of kitchen, cupboards, trolleys must be cleaned regularly. Cracks and crevices and such areas must be filled. There should not be any place in a home, where accumulation of garbage may take place.

Cockroaches frequently enter home by migrating up from sewer connections if the drain trap is dry. So always keep the drain trap filled with water.

**2. Chemical control :** Organophosphates, carbamates, pyrethroids and boric acid are efficient poisons of cockroaches, various types of their formulations are available in market, under various brand names.



### Do you know ?

Cockroaches are considered as bio-indicators! Their presence indicate unhygienic conditions.



### Internet my friend

Collect the information about techniques and objectives of rearing the cockroaches in countries like China and make a powerpoint presentation including video clips.

### Interesting information :-

Different insects feed upon different types of food materials. Ex : Butterflies feed upon nectar, mosquito (female) and bedbugs on human blood, mantis on other animals, etc.

**Depending upon nature of food and feeding habits, different insects have different types of mouthparts. Collect images of different mouthparts and paste in appropriate boxes.**

Siphoning mouth parts  
(Butterfly)

Sponging mouthpart  
(Housefly)

Piercing and sucking  
mouthpart  
(female mosquito)

Piercing and sucking  
(bed bug)

Chewing and biting  
(praying mantis)

Chewing and lapping  
(honey bee)



## Exercise

### 1. Choose correct option

- A. Chemical nature of chitin is .....  
a. protein.      b. carbohydrate.  
c. lipid.          d. glycoprotein.
- B. Cockroach has ..... type of mouthparts.  
a. sponging  
b. chewing and biting  
c. piercing and Sucking  
d. lapping
- C. Spiracle is a part of ..... system of cockroach.  
a. circulatory                      b. respiration  
c. reproductive                    d. nervous
- D. .... is a part of digestive system.  
a. Trachea      b. Hypopharynx  
c. Haemocyte   d. Seminal vesicle
- E. .... is also called as brain of cockroach.  
a. Supra-oesophageal ganglion  
b. Sub-oesophageal ganglion  
c. Hypo-cerebral ganglion  
d. Thoracic ganglion

### 2. Answer the following questions

- A. Describe the digestive system of cockroach.
- B. Give an account on tracheal system of cockroach?
- C. Describe nervous system of cockroach.
- D. With help of neat labelled diagram, describe female reproductive system of cockroach.
- E. With help of neat labelled diagram, describe the digestive system of cockroach.
- F. A student observed that the cockroaches are killed for dissection by simply putting them in soap water. He inquired whether soap is so poisonous. Teacher said it is due to its peculiar respiratory system. How?

- G. Describe the circulatory system of cockroach.

### 3. Answer the following questions

- A. How will you identify male or female cockroach?
- B. Write a note on : Gizzard of cockroach.
- C. Give the systematic position of cockroach.
- D. What would have happened if cockroach did not had gizzard?
- E. What is the functional difference between eyes of cockroach and human being?
- F. What is the functional difference between respiratory systems of cockroach and human being?

### 4. Explain the following in short

- A. What are anal cerci?
- B. What is the ganglion?
- C. What is the role of hypopharynx?
- D. What is mesenteron?
- E. Location of turgum.
- F. What is ootheca?
- G. How many chambers are present in heart of cockroach?

### Practical / Project :

Visit to nearest sericulture farm and study the life cycle of silk worm.

## 12. Photosynthesis



### Can you recall?

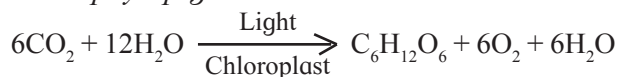
1. Why energy is essential in different life processes?
2. How do we get energy?



### Use your brain power

Justify: All life on earth is 'bottled solar energy'.

Photosynthesis is the only process on earth by which solar energy is trapped by green plants and converted into food. Photosynthesis is defined as *synthesis of carbohydrates (glucose) from inorganic materials as CO<sub>2</sub> and H<sub>2</sub>O with the help of solar energy trapped by chlorophyll pigments.*



This process is unique to green plants and is the final light energy trapping process on which all life ultimately depends. It is one of the most massive chemical processes going on earth.

Atmosphere contains only about 0.03 percent carbon dioxide by volume. This small percentage represents 2200 billion tons of CO<sub>2</sub> in the atmosphere. The oceans contain over 50 times by amount of atmospheric CO<sub>2</sub> in the form of dissolved gas or carbonates. From these two sources, about 70 billion tons of carbon is fixed by the green plants annually.

### 12.1 Chloroplast :

These are mainly located in the mesophyll cells of leaves. The CO<sub>2</sub> reaches them through the stomata and water reaches them through veins. In higher plants, the chloroplasts are discoid or lens-shaped. Each chloroplast is bounded by double membrane. Inside the membranes is found a ground substance, the *stroma*. Inside the stroma is found a system of chlorophyll bearing double-membrane sacs or lamellae. These are stacked one above the other to form *grana* (singular, granum). Individual sacs in each *granum* are known as *thylakoids*.

All the pigments chlorophylls, carotenes and xanthophylls are located in the thylakoid membranes. These pigments absorb light of a specific wave lengths in the visible region. The pigments are fat soluble and located in the lipid part of the membrane. With the help of certain enzymes, they participate in the conversion of solar energy into ATP and NADPH<sub>2</sub>. The enzymes of stroma utilize ATP and NADPH<sub>2</sub> to produce carbohydrates.

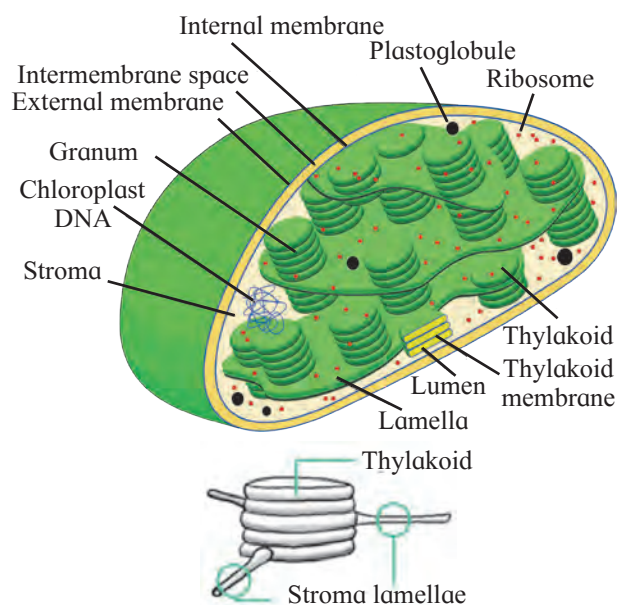


Fig. 12.1 Ultrastructure of Chloroplast

### Two predominant types of chlorophylls :

Chlorophyll *a* and *b* differ in the nature of side groups. Chlorophyll *a* has a methyl group (-CH<sub>3</sub>) while chlorophyll *b* has an aldehyde group (-CHO). Chemically chlorophyll molecule consists of two parts head of tetrapyrrol the *Porphyrin ring* and a long hydrocarbon tail called *phytyl attached* to the porphyrin group. Carotenoids are lipid compounds present universally in almost all the higher plants and several micro-organisms. They are usually red, orange, yellow, brown, and are associated with chlorophyll. They are of two types - the *carotenes* and *xanthophylls*. The carotenes (C<sub>40</sub>H<sub>56</sub>) are orange red and xanthophylls contain oxygen. The light energy absorbed by the carotenoids is transferred to chlorophyll *a* to be utilized in photosynthesis.



### Internet my friend

**Collect information :** Why does chlorophyll appear red in reflected light and green in transmitted light?



### Activity 1

Grind the spinach leaves in small quantity of acetone / nail paint remover. Mix the contents properly and filter with filter paper in test-tube. Test-tube contains green filtrate. Take the test-tube in dark-room and put a flash of torch on it. Now, solution appears red. Why does this occur? Which phenomenon is this? Discuss this with your physics, chemistry and biology teachers.



### Activity 2

To separate the chloroplast pigments by paper chromatography. Concentrate the extracted chlorophyll solution by evaporation. Apply a drop of it at one end, 2cm away from edge of a strip of chromatography paper and allow it to dry thoroughly. Take a mixture of petroleum ether and acetone in the ratio of 9 : 1 at temperature of 40 to 60°C. Hang the strip in the jar with its loaded end dipping in the solvent. Close the jar tightly and keep it for an hour. The pigments separate into distinct green and yellow bands of chlorophyll and carotenoid respectively.



### Can you tell?

Tomatoes, carrots and chillies are red in colour due to presence of pigments. Name the pigment.

All photosynthetic plants have these pigments that absorb light between the red and blue region of the spectrum. Carotenoids found mainly in higher plants absorb primarily in the violet to blue regions of the spectrum. They not only absorb light energy and transfer it to chlorophyll but also protect the chlorophyll molecules from photo-oxidation.

## 12.2 Nature of Light :

Light is a form of electromagnetic radiation. According to quantum theory, it travels as stream of tiny particles called photons. A photon contains a quantum of light. According to wave theory, light travels in the form of waves of different wavelengths having different colors. One can see electromagnetic radiation with wavelengths ranging from 390nm to 730nm. This part of the spectrum is called the Visible light. It lies between wavelengths of ultraviolet and infra-red.

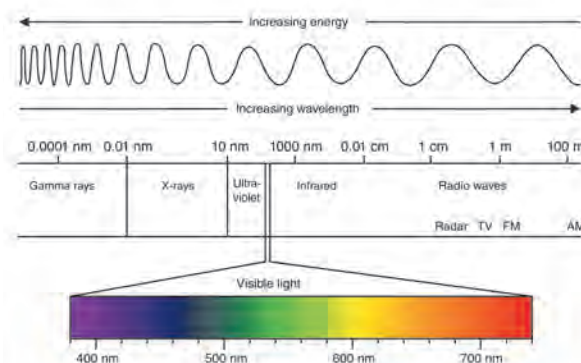
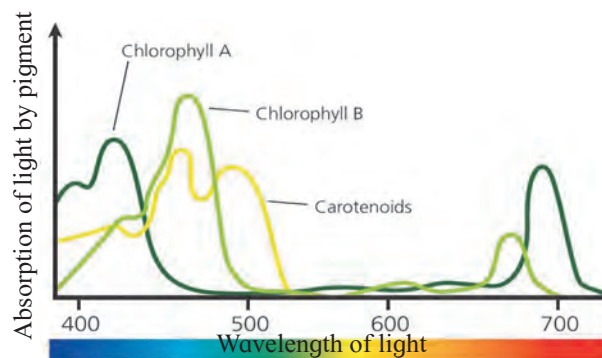


Fig. 12.2 Electromagnetic spectrum of light

### Absorption and Action spectrum :

All the photosynthetic pigments have ability to absorb different wavelengths of light. The light absorbed at each wavelength by different pigments, can be shown in the form of a graph. Such a graph showing the absorption of light at different wavelengths by different pigments, is termed as *Absorption spectrum*.

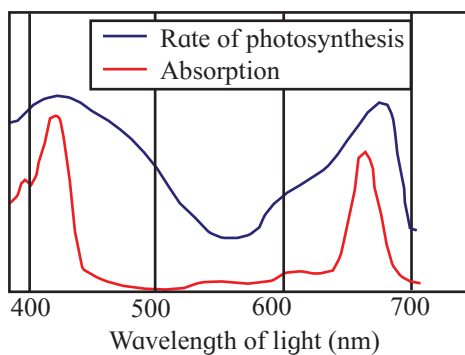


Graph 12.3 Absorption spectrum

The absorption spectrum of chlorophyll *a* and *b* clearly shows that more light is absorbed at blue, violet and red wavelengths of the visible spectrum. Graph showing the rate of photosynthesis at different wavelengths of light is called *Action Spectrum*.

The relative rate of photosynthesis at different wavelengths indicates close relationship with absorption spectrum of chlorophyll *a* and *b*.

Comparison of absorption spectrum for chlorophyll pigments and the action spectrum for chlorophyll pigments shows that wavelengths of light absorbed (red and blue) by chlorophyll pigments are very similar to the wavelengths that caused photosynthesis. Thus, absorption and action spectra overlap each other. In other words, the absorption and the action spectra for chlorophyll *a* and *b*, coincide.



**Graph 12.4 Action spectrum for photosynthesis**



### Can you tell?

1. What made Hill to perform his experiment?
2. Distinguish between action spectrum and absorption spectrum.
3. Draw well labelled diagram of chloroplast.



### Use your brain power

The photosynthetic lamellae taken out from a chloroplast and suspended in a *nutrient medium* in the presence of  $\text{CO}_2$  and light. Will they synthesize sugar or not?

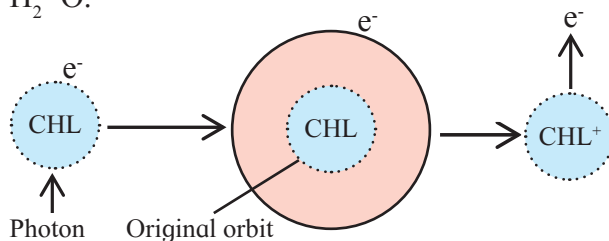
## 12.3 Mechanism of Photosynthesis :

In 1931, Van Niel proved that bacteria

used  $\text{H}_2\text{S}$  and  $\text{CO}_2$  to synthesize carbohydrates as follows :



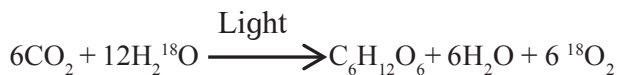
This led Van Niel to postulate that in green plants, water is utilized in place of  $\text{H}_2\text{S}$  and  $\text{O}_2$  is evolved in place of sulphur. Ruben (in 1941) confirmed it in *Chlorella*. He used water labeled with heavy isotope of oxygen ( $^{18}\text{O}_2$ ) i.e.  $\text{H}_2^{18}\text{O}$ .



**Ground state    Excited state    Ionized chlorophyll-a**

### Fig. 12.5 Photoexcitation of chlorophyll-a

The oxygen evolved contain  $^{18}\text{O}_2$  thereby proving Van Neil's hypothesis that oxygen evolved in photosynthesis comes from water. This leads to the currently accepted general equation of photosynthesis -



In 1937, R. Hill cultured the isolated chloroplasts in a medium containing water (devoid of any trace of dissolved  $\text{CO}_2$ ) and ferric compound. On illumination (exposure to light), he observed that there was change in the colour of ferric compound due to reduction, caused by  $\text{H}_2$ , removed from water through its photolysis. The source of evolved  $\text{O}_2$  must be from water and not from  $\text{CO}_2$ . This observation directly proves that  $\text{H}_2$  comes from water as a result of photolysis and  $\text{O}_2$  is evolved. Later Ruben and Kamen, by using isotopic oxygen ( $^{18}\text{O}_2$ ) confirmed Hill's findings.

By adding haemoglobin in the culture medium, one can directly prove that the source of evolving oxygen is water. This is because due to action of evolved oxygen, haemoglobin turns red in colour forming oxyhaemoglobin. This observation confirmed that  $\text{H}_2\text{O}$  must have been oxidized, releasing  $\text{O}_2$  that reacted with haemoglobin. Hill indirectly proved that the source of evolving  $\text{O}_2$  is  $\text{H}_2\text{O}$  and not  $\text{CO}_2$ .

Therefore, it is called Hill reaction.

Thus Hill reaction proves that :

- In photosynthesis, oxygen is released from water.
- Electrons for the reduction of  $\text{CO}_2$  are obtained from water.



### Think about it

Large number of gas bubbles are evolved during day time in a pond of water.

According to Arnon, in this process light energy is converted to chemical energy. This energy is stored in ATP and  $\text{NADPH}_2$  is formed as hydrogen donor. This ATP formation is known as photophosphorylation.



### Think about it

Does moon light support photosynthesis?

In modern concept, the process of photosynthesis is an oxidation and reduction process in which water is oxidized (to release  $\text{O}_2$ ) and  $\text{CO}_2$  is reduced to form sugar. Process consists of two major reactions viz, i. light reaction (photochemical) that requires light and ii. the other reaction is dark reaction which is independent of light (also called biochemical reaction). These two reactions occur successively i.e. light reaction is followed by dark reaction (also called Blackman's reaction).

## 12.4 Light reaction :

In light reaction, solar energy is trapped by chlorophyll and stored in the form of chemical energy as ATP and in the form of reducing power as  $\text{NADPH}_2$ . Oxygen is evolved in the light reaction by splitting of water.

When a photon is absorbed by chlorophyll molecule, an electron is boosted to higher energy level. To boost an electron, a photon must have a certain minimum quantity of energy called *quantum energy*. A molecule that has absorbed a photon is in energy rich *excited state*. When the light source is turned off, the high energy electrons return rapidly to their normal low energy orbitals as the excited molecule reverts to its original stable condition, called the *ground state*.

**Reaction centre :** The light absorbing pigments are located in the thylakoid membranes. They are arranged in clusters of chlorophyll and accessory pigments along with special types of chlorophyll molecules  $\text{P}_{680}$  and  $\text{P}_{700}$  (the letter P stands for Pigment and 680 and 700 for the wavelengths of light at which these molecules show maximum absorbance).  $\text{P}_{680}$  and  $\text{P}_{700}$  molecules form the *Reaction centers* or *Photocenters*.

The accessory pigments and other chlorophyll molecule harvest solar energy and pass it on the reaction centers. These are called *Light harvesting* or *Antenna molecules*. They function to absorb light energy, which they transmit at a very high rate to the reaction center where the photochemical act occurs.

**Photosystems I and II :** The thylakoid membranes of chloroplasts have two kinds of photosystems, each with its own set of light harvesting chlorophyll and carotenoid molecules. Chlorophyll and accessory pigments help to capture light energy and pass it on to the photocenters. Thus, a photon absorbed anywhere in the harvesting zone of a  $\text{P}_{680}$  center, can pass its energy to the  $\text{P}_{680}$  molecule. The cluster of pigment molecules which transfer their energy to  $\text{P}_{680}$  absorb at or below the wavelength 680nm. Together with  $\text{P}_{680}$  they form *Photosystem-II* or *PS-II*. Likewise,  $\text{P}_{700}$  forms *Photosystem-I* or *PS-I* along with pigment molecule which absorbs light at or below 700nm.

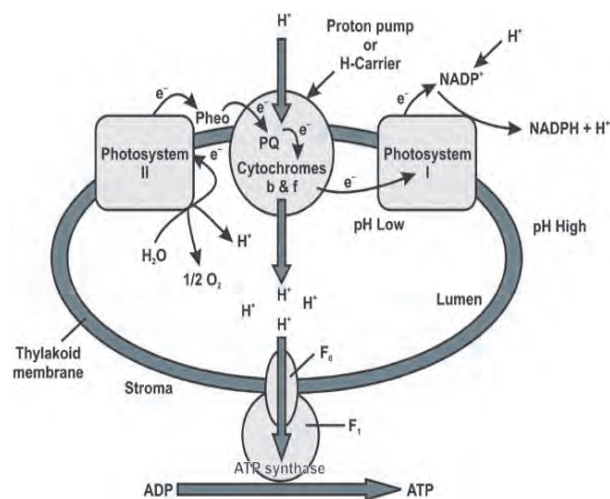
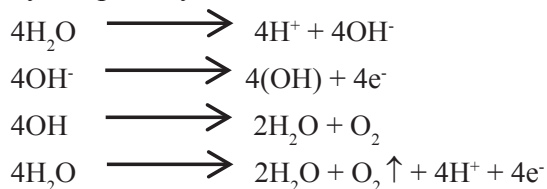


Fig. 12.6 ATP synthesis through chemiosmosis

**Photosystem II :** This system brings about photolysis of water and release of oxygen. In this act, when PS-II absorbs light, electrons are released and chlorophyll molecule is oxidized. The electrons emitted by  $P_{680}$  (PS-II) are ultimately trapped by  $P_{700}$  (PS-I).

The oxidized  $P_{680}$  regains its electrons by the photolysis of water as follows:



Oxygen is given out as byproduct by the photosynthesizing plants. Protons ( $H^+$ ) accumulate inside the thylakoid resulting in a *Proton gradient*.

The energy released by the protons when they diffuse across the thylakoid membrane into the stroma against the  $H^+$  concentration gradient is used to produce ATP.

**Photosystem I :** When light quanta are absorbed by photosystem I ( $P_{700}$ ), energy rich electrons are emitted from the reaction center. These flow down a chain of electron carriers to NADP along with the proton generated by splitting of water. This results in the formation of  $NADPH_2$ .

Hydrogen attached to  $NADPH_2$  is used for reduction of  $CO_2$  in dark reaction. This is also called *Reducing power of the cell*.

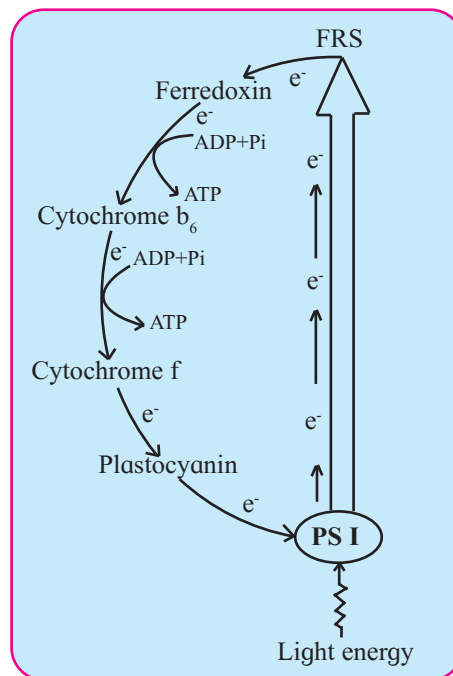
## 12.5 Photophosphorylation :

Formation of ATP in the chloroplasts in presence of light is called photophosphorylation. It takes place in the two forms.

### i. Cyclic photophosphorylation :

Illumination of photosystem-I causes electrons to move continuously out of the reaction center of photosystem-I and back to it.

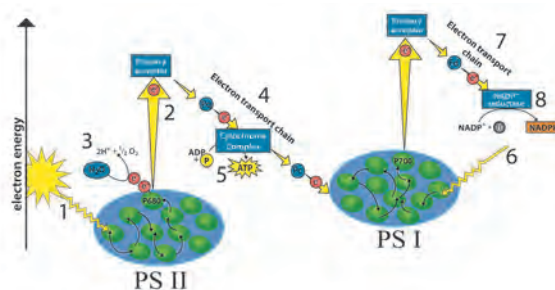
The cyclic electron-flow is accompanied by the photophosphorylation of ADP to yield ATP. This is termed as *Cyclic photophosphorylation*. Since this process involves only pigment system I, photolysis of water and consequent evolution of oxygen does not take place.



**Fig. 12.7 Cyclic photophosphorylation**

### ii. Non-cyclic photophosphorylation :

It involves both PS-I and PS-II photosystems. In this case, electron transport chain starts with the release of electrons from PS-II. In this chain high energy electrons released from PS-II do not return to PS-II but, after passing through an electron transport chain, reach PS-I, which in turn donates it to reduce  $NADP^+$  to  $NADPH$ . The reduced  $NADP^+$  ( $NADPH$ ) is utilized for the reduction of  $CO_2$  in the dark reaction.



**Fig. 12.8 Non-cyclic photophosphorylation (For details, refer page no. 216 of the book)**

Electron-deficient PS-II brings about oxidation of water-molecule. Due to this, protons, electrons and oxygen atom are released. Electrons are taken up by PS-II itself to return to reduced state, protons are accepted by  $NADP^+$  where as oxygen is released.



As in this process, high energy electrons released from PS-II do not return to PS-II and it is accompanied with ATP formation, this is called *Non-cyclic photophosphorylation*.

Thus, during the photochemical reactions, photolysis of water takes place,  $O_2$  is released and ATP and  $NADPH_2$  are synthesized. ATP and  $NADPH_2$  molecules function as vehicles for transfer of energy of sunlight into dark reaction leaving to carbon fixation. In this reaction  $CO_2$  is reduced to carbohydrate.

The light reaction gives rise to two important products : i. A reducing agent  $NADPH_2$  and ii. An energy rich compound ATP. Both these are utilized in the dark phase of photosynthesis.

### 12.6 Dark reaction :

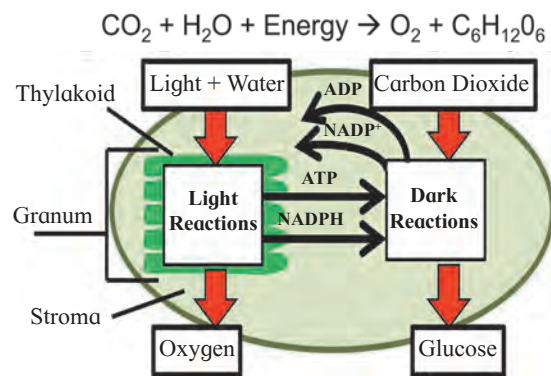
Carbon fixation occurs in the stroma by a series of enzyme catalyzed steps. Molecules of ATP and  $NADPH_2$  produced in the thylakoids (light reaction) come in the stroma where carbohydrates are synthesized.

The path of carbon fixation in dark reaction through intermediate compounds leading to the formation of sugar and starch was worked out by **Calvin, Benson** and their co-workers. For this, *Calvin* was awarded *Nobel Prize* in 1961.

Path of carbon was studied with the help of radioactive tracer technique using *Chlorella*, a unicellular green alga and radioactive  $^{14}CO_2$ . With the help of radioactive carbon, it becomes possible to trace the intermediate steps of fixation of  $^{14}CO_2$ . The various steps in the dark reactions (Calvin cycle / C-3 pathway, fig. 12.10) are as follows:

**1. Carboxylation :**  $CO_2$  reduction starts with a 5-carbon sugar, ribulose-1,5-bisphosphate (RuBP). It is a 5-carbon sugar (pentose) with two phosphate groups attached to it.

RuBP reacts with  $CO_2$  to produce unstable- 6-carbon intermediate in the presence of an enzyme *RuBP carboxylase* or *Rubisco* and immediately splits into 3-carbon compound, 3-phosphoglyceric acid (3-PGA). Rubisco is a large protein molecule and comprises 16% of the chloroplast proteins.



**Fig. 12.9 Relation between light and dark reaction**

**2. Glycolytic Reversal :** Molecules of 3-PGA form 1,3-diphosphoglyceric acid utilizing ATP molecules. These are reduced to glyceraldehyde-3-phosphate (3-PGAL) by  $NADPH_2$  supplied by the light reactions of photosynthesis.

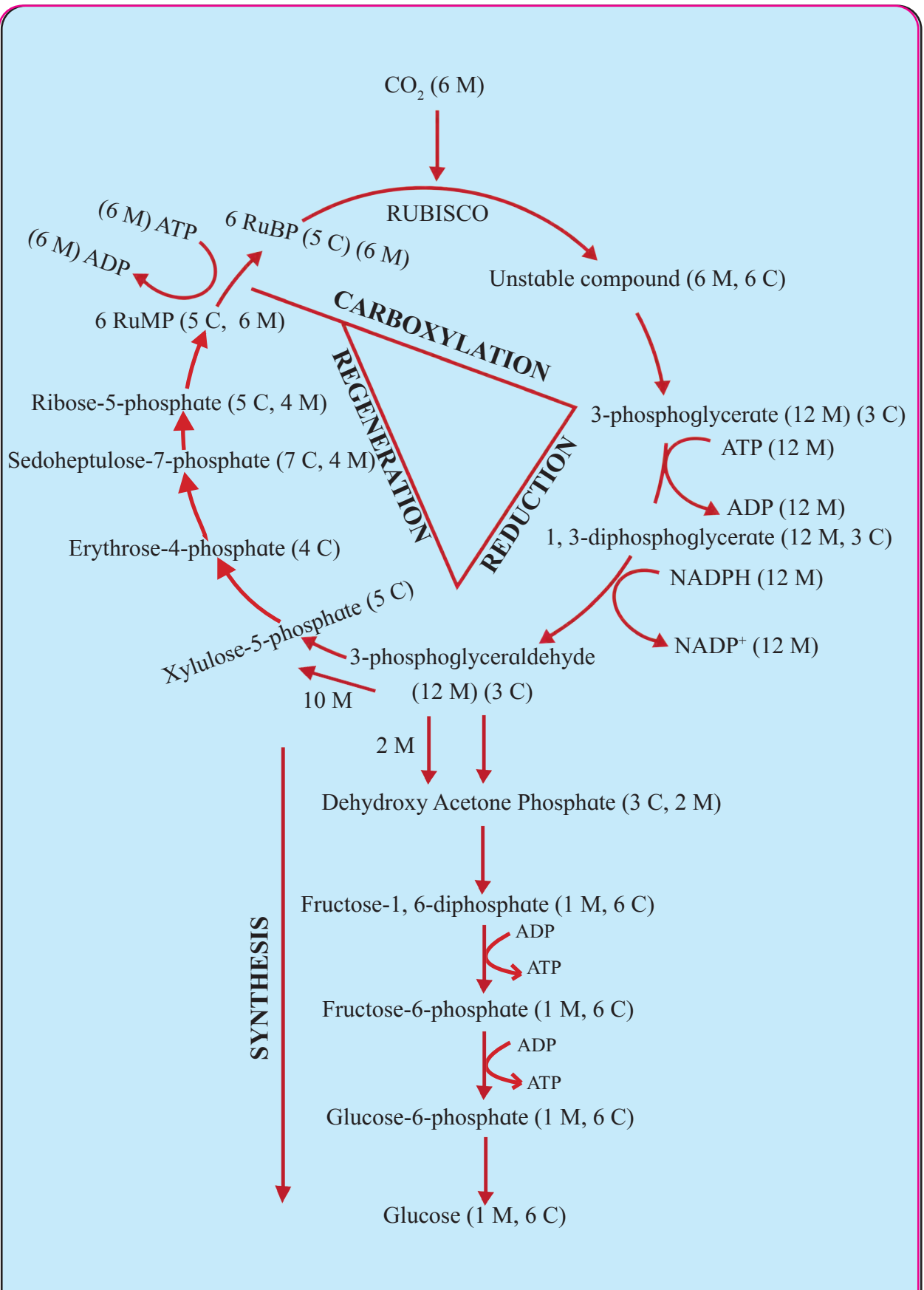
For the Calvin cycle to run continuously, there must be sufficient amount of RuBP which accepts  $CO_2$  and a regular supply of ATP and  $NADPH_2$ . Out of each of 12 molecules of 3-phosphoglyceraldehyde (3-PGAL), 2 molecules are used for synthesis of one glucose molecule and remaining 10 molecules are used for regeneration of 6 molecules of RuBP.

**3. Regeneration of RuBP :** Through a series of complex reactions, 10 molecules of 3-PGAL are used for regeneration of six molecules of RuBP at the cost of 6 ATP. For this purpose, six turns of Calvin cycle are needed to be operated so that a molecule of glucose can be synthesized.

Plants form a variety of organic compounds required for its structure and function through these complex reactions.

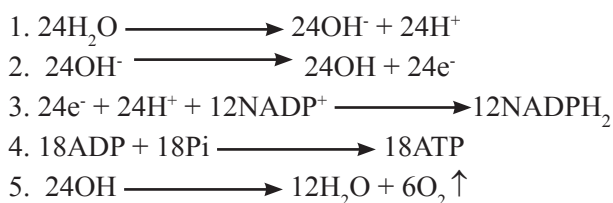
Thus, for every 6 molecules of  $CO_2$  and Ribulose-1, 5-biphosphate used, 12 molecules of 3-phosphoglyceraldehyde are produced. Out of these 12 molecules, only two are utilized for the formation of a molecule of glucose; the other 10 molecules are converted into ribulose-1, 5-biphosphate which combines with fresh  $CO_2$ .

Thus, the Calvin cycle regenerates ADP and NADP required for the light reaction.

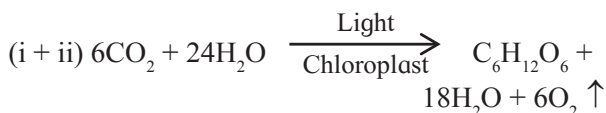
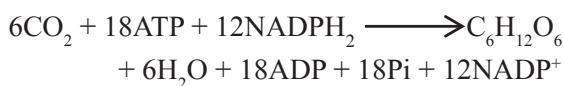


**Fig. 12.10 Calvin cycle and regeneration of RuBP**  
[C<sub>3</sub> pathway / cycle]

i. Light Reaction (in granum) :



ii. Dark reaction (in stroma) :



**Can you tell?**

1. How chlorophyll - a is excited? Show it with a diagram.
2. Describe Calvin's cycle.
3. Draw a flowchart of non-cyclic photophosphorylation.

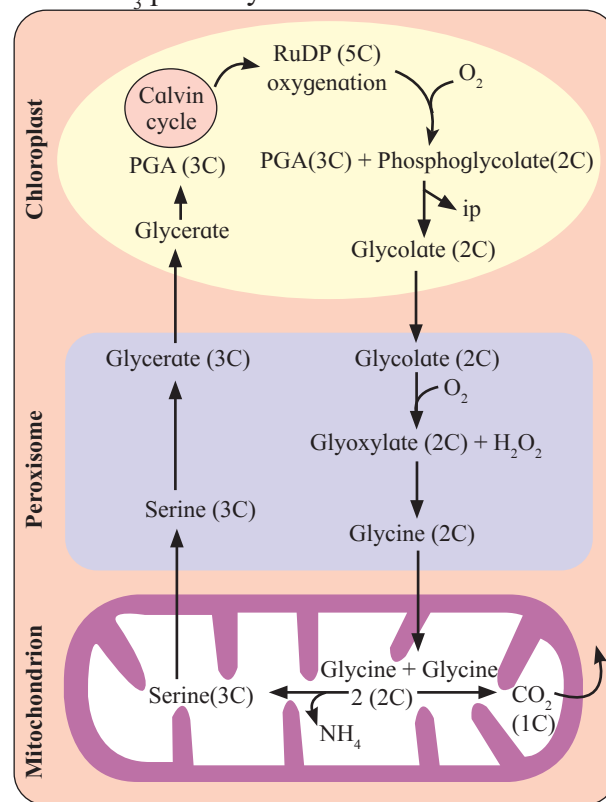
### 12.7 Photorespiration :

Photorespiration occurs under the conditions like high temperature, bright light, high oxygen and low  $\text{CO}_2$  concentration. It is a wasteful process linked with  $\text{C}_3$ -Cycle, where instead of fixation of  $\text{CO}_2$ , it is given out.

It involves three organelles chloroplast peroxisomes and mitochondria, and occurs in a series of cyclic reactions which is also called PCO cycle. Enzyme Rubisco acts as oxygenase at higher concentration of  $\text{O}_2$  and photorespiration begins. When RuBP reacts with  $\text{O}_2$  rather than  $\text{CO}_2$  to form a 3-carbon compound (PGA) and 2-carbon compound phosphoglycolate. Later is converted to glycolate which is shuttled out of the chloroplast into the peroxisomes.

In peroxisomes, enzyme glycolate oxidase converts glycolate into glyoxylate, which is converted into amino acid glycine by transamination. In mitochondria, two molecules of glycine are converted into serine (amino acid) and  $\text{CO}_2$  is given out. Thus, it loses 25% of photosynthetically fixed carbon. Serine is transported back to peroxisomes and

converted into glycerate. It is shuttled back to chloroplast to undergo phosphorylation and utilized in formation of 3-PGA, which is then used in  $\text{C}_3$  pathway.



**Fig. 12.11 Photorespiration**

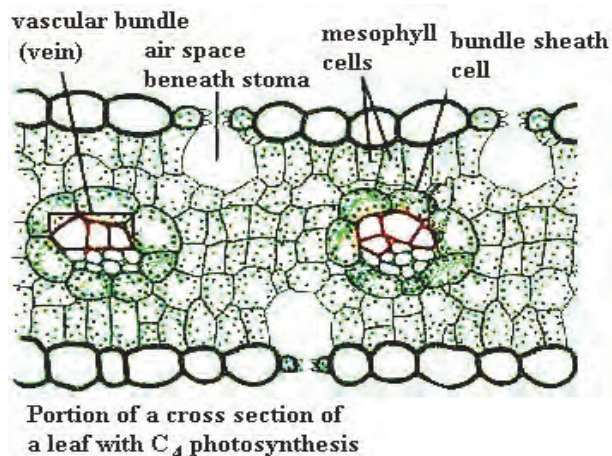
### 12.8 $\text{C}_4$ pathway or Hatch-Slack pathway :

M. D. Hatch and C. R. Slack while working on sugarcane, found four carbon compound (dicarboxylic acid) as the first stable product of photosynthesis. It has been also found to occur in tropical and sub-tropical grasses and some dicotyledons. Some of the important plants are sugarcane, maize, *Sorghum* etc.

The plants in which  $\text{CO}_2$  fixation takes place by Calvin cycle are called  $\text{C}_3$  plants, because first product of  $\text{CO}_2$  fixation is a 3-carbon compound, phosphoglyceric acid. But in Hatch-Slack pathway, first product of  $\text{CO}_2$  fixation is a 4-carbon compound, oxaloacetic acid. Hence such plants are called  $\text{C}_4$  plants.

Anatomy of leaves of  $\text{C}_4$  plants is different from leaves of  $\text{C}_3$  plants.  $\text{C}_4$  plants show *Kranz anatomy*. In the leaves of such plants, there is a bundle sheath around the vascular bundles. The chloroplasts in the

bundle - sheath cells are large and almost without or less developed grana, where as in the mesophyll cells, the chloroplasts are small but with well-developed grana.



**Fig. 12.12 Kranz anatomy of  $C_4$  plant**

$CO_2$  taken from atmosphere is accepted by a 3-carbon compound, phosphoenolpyruvic acid in the chloroplasts of mesophyll cells, leading to the formation of 4-C compound, oxaloacetic acid with the help of enzyme PEPCase. It is converted to another 4-C compound, the malic acid. It is transported to the chloroplasts of bundle sheath cells. Here, malic acid (4-C) is converted to pyruvic acid (3-C) with the release of  $CO_2$  in the cytoplasm. Thus concentration of  $CO_2$  increases in the bundle sheath cells.

Chloroplasts of these cells contain enzymes of Calvin cycle. Because of high

concentration of  $CO_2$ , RuBP carboxylase participates in Calvin cycle and not in photorespiration. Sugar formed in Calvin cycle is transported into the phloem.

Pyruvic acid generated in the bundle sheath cells re-enters mesophyll cells and regenerates phosphoenolpyruvic acid by consuming one ATP.

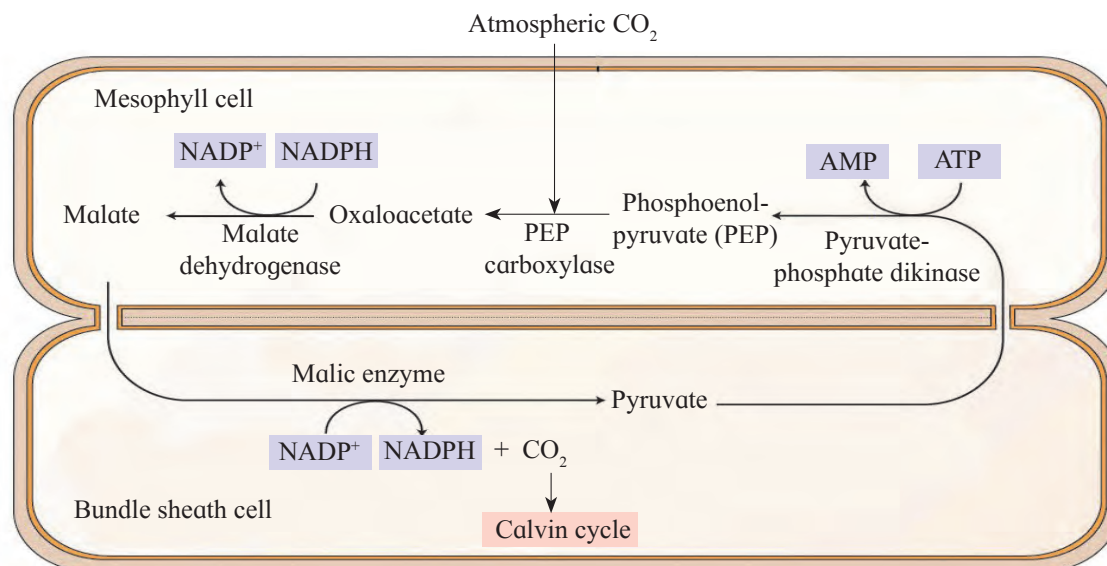
Since this conversion results in the formation of AMP (not ADP), two ATP are required to regenerate ATP from AMP. Thus  $C_4$  pathway needs 12 additional ATP. The  $C_3$  pathway requires 18 ATP for the synthesis of one glucose molecule, whereas  $C_4$  pathway requires 30 ATP.

Thus,  $C_4$  plants are better photosynthesizers as compared to  $C_3$  plants, as there is no photorespiration in these plants. Moreover,  $C_4$  plants can fix  $CO_2$ , even if concentration of  $CO_2$  in atmosphere is very low.

### 12.9 CAM-Crassulacean Acid Metabolism:

It is one more alternative pathway of carbon fixation found in desert plants. It was first reported in the family Crassulaceae, so called as CAM (Crassulacean Acid Metabolism).

In CAM plants, stomata are scotoactive i.e. active during night, so initial  $CO_2$  fixation occurs in night.



**Fig. 12.13  $C_4$  Pathway**

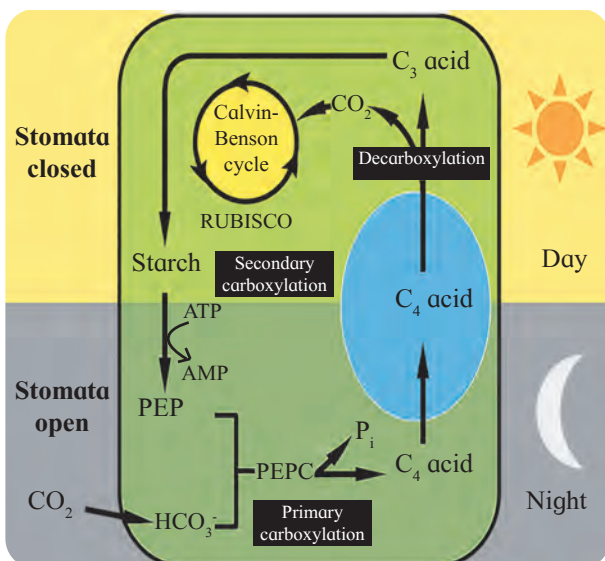
Thus C<sub>4</sub> pathway fix CO<sub>2</sub> at night and reduce CO<sub>2</sub> in day time via the C<sub>3</sub> pathway by using NADPH formed during the day. PEP carboxylase and Rubisco are present in the mesophyll cell (no Kranz anatomy).

Formation of malic acid during dark is called acidification (phase I).

Malate is stored in vacuoles during the night. Malate releases CO<sub>2</sub> during the day for C<sub>3</sub> pathway within the same cell is called deacidification (phase II).

Examples of CAM plants : *Kalanchoe*, *Opuntia*, *Aloe* etc.

The Chemical reactions of the carbon di-oxide fixation and its assimilation are similar to that of C<sub>4</sub> plants.



**Fig. 12.14 Crassulacean acid metabolism**



**Can you tell?**

1. C<sub>4</sub> plants are more productive. Why?
2. Xerophytic plants survive in high temperature. How?
3. Summarise the photosynthetic reaction.
4. Compare C<sub>4</sub> plants and CAM plants.

**12.10 Factors affecting Photosynthesis :**

Like all other physiological processes, photosynthesis is also influenced by a number of factors.

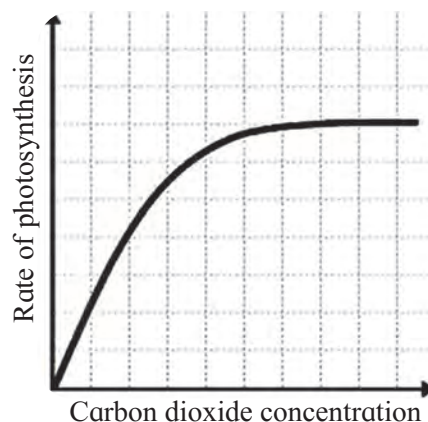
**A. External Factors :**

**Light :** It is an essential factor as it supplies

the energy necessary for photosynthesis. Both quality and intensity of light affect photosynthesis. Highest rate of photosynthesis takes place in the red wave length and then come the blue wave length. In a forest canopy the rate of photosynthesis decreases considerably in plants growing under it.

In most of the plants, photosynthesis is maximum in bright diffused sunlight. It decreases in strong light and again slows down in the light of very low intensity. It has also been found that uninterrupted and continuous photosynthesis for relatively long periods of time may be sustained without any visible damage to the plant.

**Carbon dioxide :** The main source of CO<sub>2</sub> in land plants is the atmosphere, which contains only 0.03% of the gas. Under normal conditions of temperature and light, carbon dioxide acts as a limiting factor in photosynthesis. An increase in concentration of CO<sub>2</sub> increases the photosynthesis. The increase in CO<sub>2</sub> to about 1% is generally advantageous to most of the plants. Higher concentration of the gas has an inhibitory effect on photosynthesis.



**Graph. 12.15 Effect of CO<sub>2</sub> concentration**

**Temperature :** Like all other physiological processes, photosynthesis also needs a suitable temperature. In the presence of plenty of light and carbon dioxide, photosynthesis increases with the rise of temperature till it becomes maximum. After that there is a decrease or fall in the rate of the process.

The optimum temperature at which the photosynthesis is maximum is  $25 - 30^{\circ}\text{C}$ , though in certain plants like *Opuntia*, photosynthesis takes place at as high as  $55^{\circ}\text{C}$ . This is known as the maximum temperature. The temperature at which the process just starts is the minimum temperature.

**Water :** Being one of the raw material, water is also necessary for the photosynthetic process. An increase in water content of the leaf results in the corresponding increase in the rate of photosynthesis. Thus the limiting effect of water is not direct but indirect. It is mainly due to the fact that it helps in maintaining the turgidity of the assimilatory cells and the proper hydration of their protoplasm.

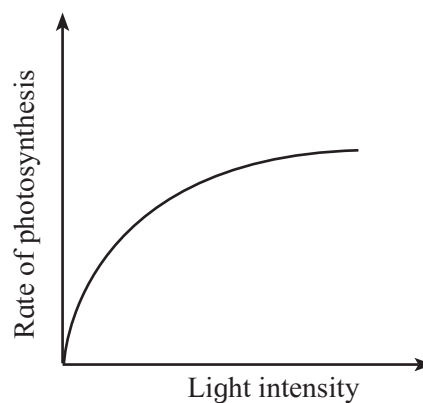
**B. Internal Factors :** Though the presence of chlorophyll is essential for photosynthesis but the rate of photosynthesis is proportional to the quantity of chlorophyll present. It is because of the fact that chlorophyll merely acts as a biocatalyst and hence a small quantity is quite enough to maintain the large bulk of the reacting substances.

The final product in the photosynthesis reaction is sugar and its accumulation in the cells slows down the process of photosynthesis. The thickness of cuticle and epidermis of the leaf, the size and distribution of intercellular spaces and the distribution of the stomata and the development of chlorenchyma and other tissues also affect the rate of photosynthesis.

#### **Blackman's law of limiting factors :**

The Blackman's law of limiting factors states that when a process is conditioned as to its rapidity by a number of separate factors, the rate of the process is controlled by the pace of the "slowest factor".

The slowest factor is that factor which is present in the lowest or minimum concentration in relation to others. The law of limiting factor can be explained by taking two external factors such as carbon dioxide and light. Suppose a plant photosynthesizing at a fixed light intensity sufficient to utilize 10mg of  $\text{CO}_2$  per hour only.



**Graph. 12.16 Light intensity and Photosynthesis**

On increasing the  $\text{CO}_2$  concentration, the photosynthetic rate also goes on increasing. Now, if the  $\text{CO}_2$  concentration is further increased, no increase in the rate of photosynthesis will be noted. Thus in this case light becomes the limiting factor. Under such circumstances, the rate of photosynthesis can be increased only by increasing the light intensity.

This evidently shows that the photosynthetic rate responds to one factor alone at a time and there would be a sharp break in the curve and a plateau formed exactly at the point where another factor becomes limiting. If any one of the other factors which is kept constant (say, light) is increased, the photosynthetic rate increases again reaching an optimum where again another factor become limiting.

**Significance :** This anabolic process uses inorganic substances and produces food for all life directly or indirectly. This process transforms solar energy into chemical energy. The released byproduct  $\text{O}_2$  is necessary not only for aerobic respiration in living organisms but also used in forming protective ozone layer around earth. This process is also helping us in providing fossil fuels, coals, petroleum and natural gas.



## Exercise

### 1. Choose correct option

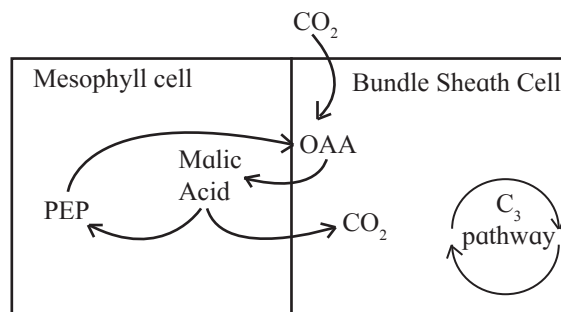
- A. A cell that lacks chloroplast does not  
a. evolve carbon dioxide  
b. liberate oxygen  
c. require water  
d. utilize carbohydrates.
- B. Energy is transferred from the light reaction step to the dark reaction step by  
a. chlorophyll    b. ADP  
c. ATP            d. RuBP
- C. Which one is wrong in photorespiration  
a. It occurs in chloroplasts  
b. It occurs in day time only  
c. It is characteristic of  $C_4$ -plants  
d. It is characteristic of  $C_3$ -plants
- D. Non-cyclic photophorylation differs from cyclic photophosphorylation in that former  
a. involves only PS I  
b. Include evolution of  $O_2$   
c. involves formation of assimilatory power  
d. both 'b' and 'c'
- E. For fixation of 6 molecules of  $CO_2$  and formation of one molecule of glucose in Calvin cycle, requires  
a. 3 ATP and 2  $NADPH_2$   
b. 18 ATP and 12  $NADPH_2$   
c. 30 ATP and 18  $NADPH_2$   
d. 6 ATP and 6  $NADPH_2$
- F. In maize and wheat the first stable products formed in bundle sheath cells respectively are  
a. OAA and PEPA  
b. OAA and OAA  
c. OAA and 3PGA  
d. 3PGA and OAA
- G. The head and tail of chlorophyll molecule are made up of  
a. porphyrin and phytin respectively  
b. pyrrole and tetrapyrrole respectively  
c. prophyrin and phyrol respectively  
d. tetrapyrrole and pyrrole respectively
- H. The net result of photo-oxidation of water is release of .....  
a. electron and proton  
b. proton and oxygen  
c. proton, electron and oxygen  
d. electron and oxygen
- I. For fixing one molecule of  $CO_2$  in Calvin cycle ..... are required  
a. 3ATP + 1 $NADPH_2$   
b. 3ATP + 2 $NADPH_2$   
c. 2ATP + 3 $NADPH_2$   
d. 3ATP + 3 $NADPH_2$
- J. In presence of high concentration of oxygen, RuBP carboxylase converts RuBP to .....  
a. Malic acid and PEP  
b. PGA and PEP  
c. PGA and malic acid  
d. PGA and phosphoglycolate
- K. The sequential order in electron transport from PSII to PSI of photosynthesis is  
a. FeS, PQ, PC and Cytochrome  
b. FeS, PQ, Cytochrome and PC  
c. PQ, Cytochrome, PC and FeS  
d. PC, Cytochrome, FeS, PQ

### 2. Answer the following questions

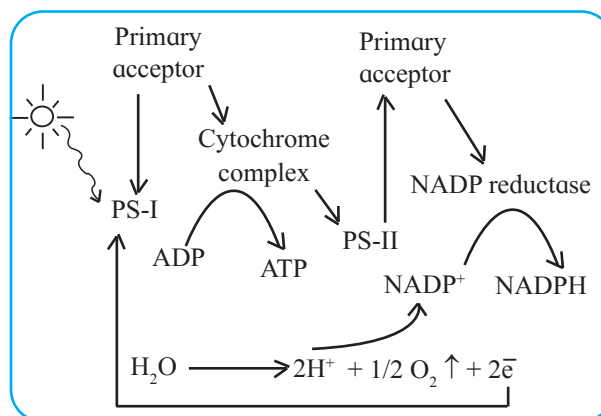
- A. Describe the light-dependent steps of photosynthesis. How are they linked to the dark reactions?
- B. Distinguish between:  
a. respiration and photorespiration  
b. absorption spectrum and action spectrum  
c. cyclic photophosphorylation and non-cyclic photophosphorylation

- C. What are the steps that are common to  $C_3$  and  $C_4$  photosynthesis?
- D. Are the enzymes that catalyse the dark reactions of carbon fixation located inside the thylakoids or outside the thylakoids?
- E. Calvin cycle consists of three phases, what are they? Explain the significance of each of them.
- F. Why are the plants that consume more than the usual 18 ATP to produce 1 molecule of glucose favoured in tropical regions?
- G. What is the advantage of having more than one pigment molecule in a photocentre?
- H. Why does chlorophyll appear green in reflected light and red transmitted light? Explain the significance of these phenomena in terms of photosynthesis.
- I. Explain why photosynthesis is considered the most important process in the biosphere.
- J. Why is photolysis of water accompanied with non-cyclic photophosphorylation?
- K. In  $C_4$  plants, why is  $C_3$  pathway operated in bundle sheath cells only?
- L. What would have happened if  $C_4$  plants did not have Kranz anatomy?
- M. Why does RUBISCO carry out preferentially carboxylation than oxygenation in  $C_4$  plants?
- N. What would have happened if plants did not have accessory pigments?
- O. How can you identify whether the plant is  $C_3$  or  $C_4$ ? Explain / Justify.
- P. In  $C_4$  plants, bundle sheath cells carrying out Calvin cycle are very few in number, even then,  $C_4$  plants are highly productive. Explain.
- Q. What is functional significance of Kranz anatomy?

### 3. Correct the pathway and name it



### 4. Is there something wrong in following schematic presentation? If yes, correct it so that photosynthesis will be operated



### Practical / Project :

1. Draw schematic presentation of different processes / cycles / reactions related to photosynthesis.
2. Check the effects of different factors on photosynthesis under the guidance of teacher.



## 13. Respiration and Energy Transfer



### Can you recall?

1. Which nutrients are used for energy production?
2. Which is most preferred nutrient among carbohydrate, protein and fat for energy production? Why?
3. Why do organisms take up oxygen and release carbondioxide?
4. What is aerobic and anaerobic respiration?
5. Which steps are involved in aerobic respiration?



### Always Remember

1. Maintenance of life requires continuous supply of energy.
2. Respiration fulfills the continuous need of energy.

### 13.1 Formation of ATP :

Formation of ATP is called as phosphorylation. In nature, phosphorylation occurs in three different ways as - **photophosphorylation**, **substrate-level phosphorylation** and **oxidative phosphorylation**. You have already learnt the photophosphorylation in the photosynthesis.

Substrate-level phosphorylation is a direct phosphorylation of ADP by transfer of a phosphate group from any suitable substrate. It occurs in cytoplasm of the cells and matrix of mitochondria.

Oxidative phosphorylation is phosphorylation of ADP at the cost of energy released during oxidation of substrates like  $\text{NADH} + \text{H}^+$  and  $\text{FADH}_2$ . This occurs on the inner mitochondrial membrane only.

When energy is required for any metabolic process, ATP is hydrolysed. ATP hydrolysis releases the energy which is used for the metabolic activities.

Respiration is a catabolic process wherein complex organic substrate is oxidized to simple components to generate biological energy. Cellular respiration occurs in two different ways as anaerobic and aerobic respiration.

### 13.2 Anaerobic respiration :

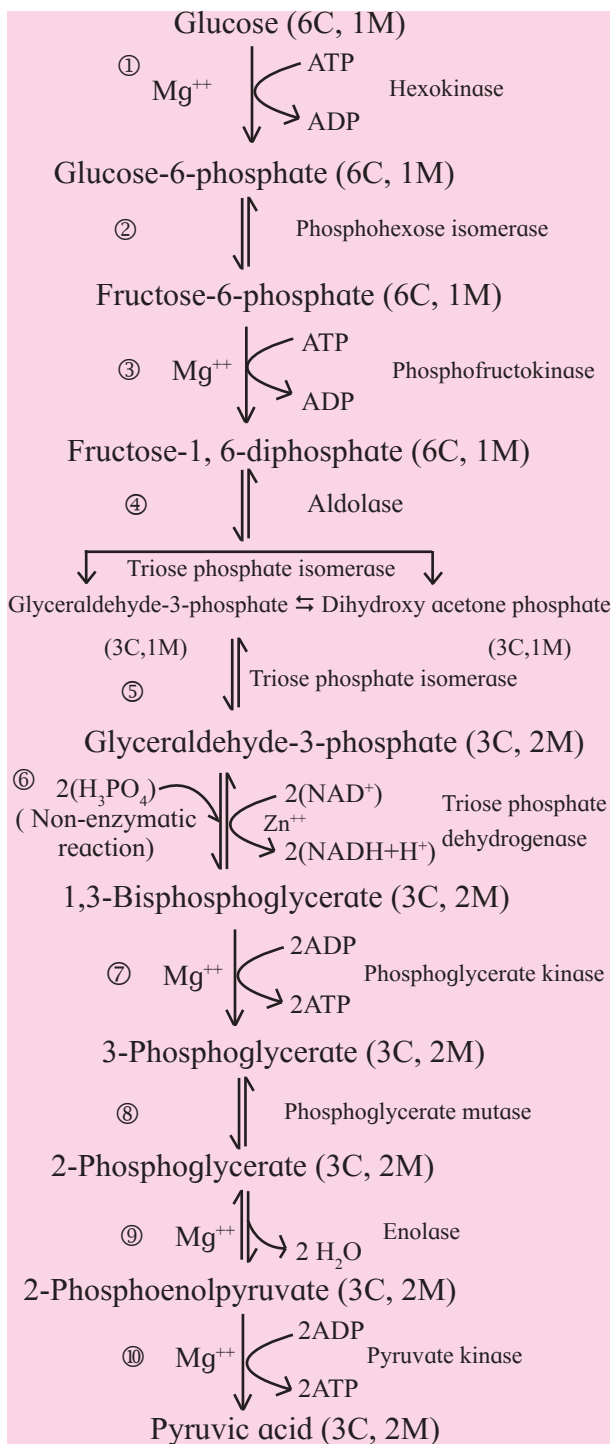
Anaerobic respiration is the cellular respiration that does not involve the atmospheric oxygen. It is also called fermentation. It is completed through steps viz. glycolysis and incomplete conversion of glycolytic products into lactic acid/ ethanol.

#### Glycolysis :

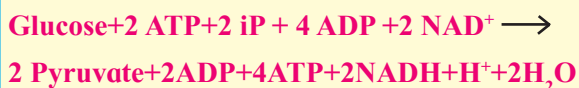
Glycolysis involves the breakdown of glucose molecule into two pyruvic acid molecules. Hence known as glycolysis. This is a common step in anaerobic as well as aerobic respiration. It occurs in cytoplasm of cell. It is completed in two phases as **preparatory phase** and **pay-off phase**.

Overall process of glycolysis is completed through ten steps. First five steps constitute the preparatory phase through which glucose is phosphorylated twice at the cost of two ATP molecules and a molecule of fructose 1, 6-bisphosphate is formed. This molecule is then split to form a molecule of glyceraldehyde 3-phosphate and a molecule of dihydroxyacetone phosphate. Both of these molecules are 3-carbon carbohydrates (trioses) and are isomers of each other. Dihydroxy acetone phosphate is isomerised to second molecule of glyceraldehyde-3-phosphate. Thus, two molecules of glyceraldehyde-3-phosphate are formed and here, first phase i.e. preparatory phase of glycolysis ends.

In the pay-off phase, both the molecules of glyceraldehyde-3-phosphate are converted to two molecules of 1, 3-bis phosphoglycerate by oxidation and phosphorylation. Here, phosphorylation is brought about with the help of inorganic phosphate and not ATP.



### Overall reaction of glycolysis:



Both molecules of 1, 3-bisphosphoglycerate are converted into two molecules of pyruvic acid through series of reactions accompanied with release of energy. This released energy is used to produce ATP (4 molecules) by substrate-level phosphorylation.

Glycolysis is under tight control. Its rate depends upon the requirement of ATP and many other factors. Glycolytic rate control is achieved by complex interplay between ATP consumption,  $\text{NADH}_2$  regeneration and regulation of various glycolytic enzymes like hexokinase, PFK-1, pyruvate kinase, etc. Besides, it is also controlled by hormones like glucagon, epinephrine and insulin.



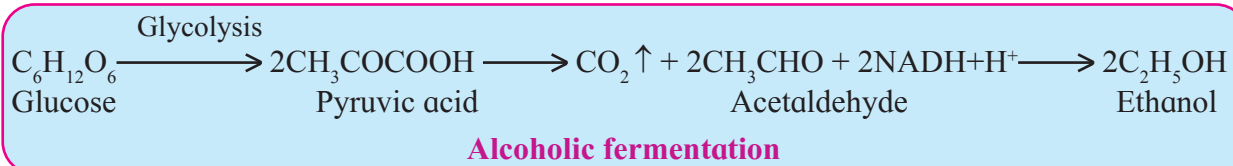
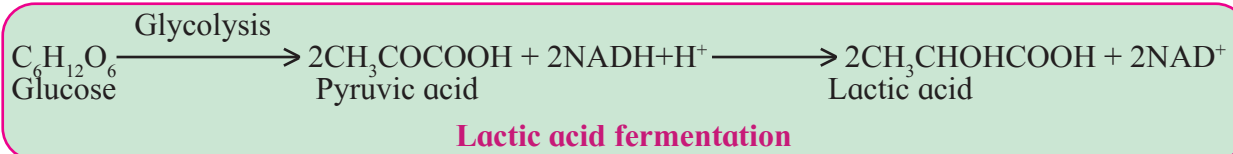
### Use your brain power

1. What is role of  $Mg^{++}$ ,  $Zn^{++}$  in various steps of glycolysis?
2. Why some reactions of glycolysis are reversible and some irreversible?
3. Why is glycolysis considered as biochemical proof of evolution?
4. Why do athletes like sprinters have higher proportion of white muscle fibers?



### Do you know?

1. Glycolysis is only source of energy production in erythrocytes, renal medulla, brain and sperm.
2. Some plant tissues which are modified to store starch (like potato) mainly depend upon glycolysis for energy production.
3. In chapter 3, Biomolecules, you have read about the oxygen storing and transporting pigment myoglobin of skeletal muscles. Red (dark) muscles are richer in myoglobin than the white (pale) muscles. Therefore, red fibers can utilize the oxygen stored in myoglobin to continue energy production over prolonged period by aerobic oxidation of glucose. This enables them to perform sustained work over a long period. On the contrary, white fibers produce the energy needed for very fast and severe work by glycolysis as sufficient oxygen is not immediately available to them for such work. But white muscles accumulate lactic acid and get fatigued in a short time. Thus athletes with a higher proportion of red fibers in their muscles are physiologically better adapted for sustained events like marathon or swimming over long distances.



In muscles, the  $\text{NADH} + \text{H}^+$  produced during glycolysis is reoxidized to  $\text{NAD}^+$  by donating one proton and two electrons to pyruvic acid which yields lactic acid. Skeletal muscles usually derive their energy by anaerobic respiration. After vigorous exercise lactic acid accumulates, leading to muscle fatigue. During rest, however, the lactic acid is reconverted to pyruvic acid and is channeled back into the aerobic respiration pathway.

In yeast, the pyruvate is decarboxylated to acetaldehyde. The acetaldehyde is then reduced by  $\text{NADH} + \text{H}^+$  to ethanol. Carbon dioxide is also produced in this process. This type of anaerobic respiration is termed alcoholic fermentation. Accumulation of ethanol by fermentation in a culture of yeast may stop further multiplication and lead to the death of cells. In the presence of oxygen however, yeast can respire aerobically.

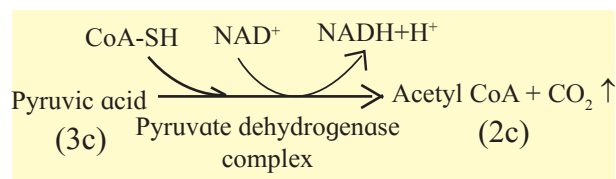
### 13.3 Aerobic Respiration :

Aerobic respiration involves molecular oxygen during oxidation of glucose. Glucose is completely oxidized in this process which is operated through steps viz. glycolysis, production of acetyl CoA (connecting link reaction), Krebs cycle, electron transfer chain reaction and terminal oxidation.

First step of aerobic respiration i.e. glycolysis has been already studied in detail. In case of aerobic respiration, glycolytic product i.e. pyruvic acid is converted into acetyl CoA. This process occurs in cytoplasm in case of prokaryotes and in mitochondria in case of eukaryotes. (For structure of mitochondria, refer Chapter 5, Cell Structure and Organization)

#### Conversion of pyruvic acid to Acetyl CoA :

This is an oxidative decarboxylation reaction. It is catalyzed by a multienzyme complex - pyruvate dehydrogenase complex (PDH). This enzyme is present in mitochondria of eukaryotes and cytosol of prokaryotes.



This reaction is called as 'connecting link' reaction between glycolysis and Krebs cycle.



#### Do you know?

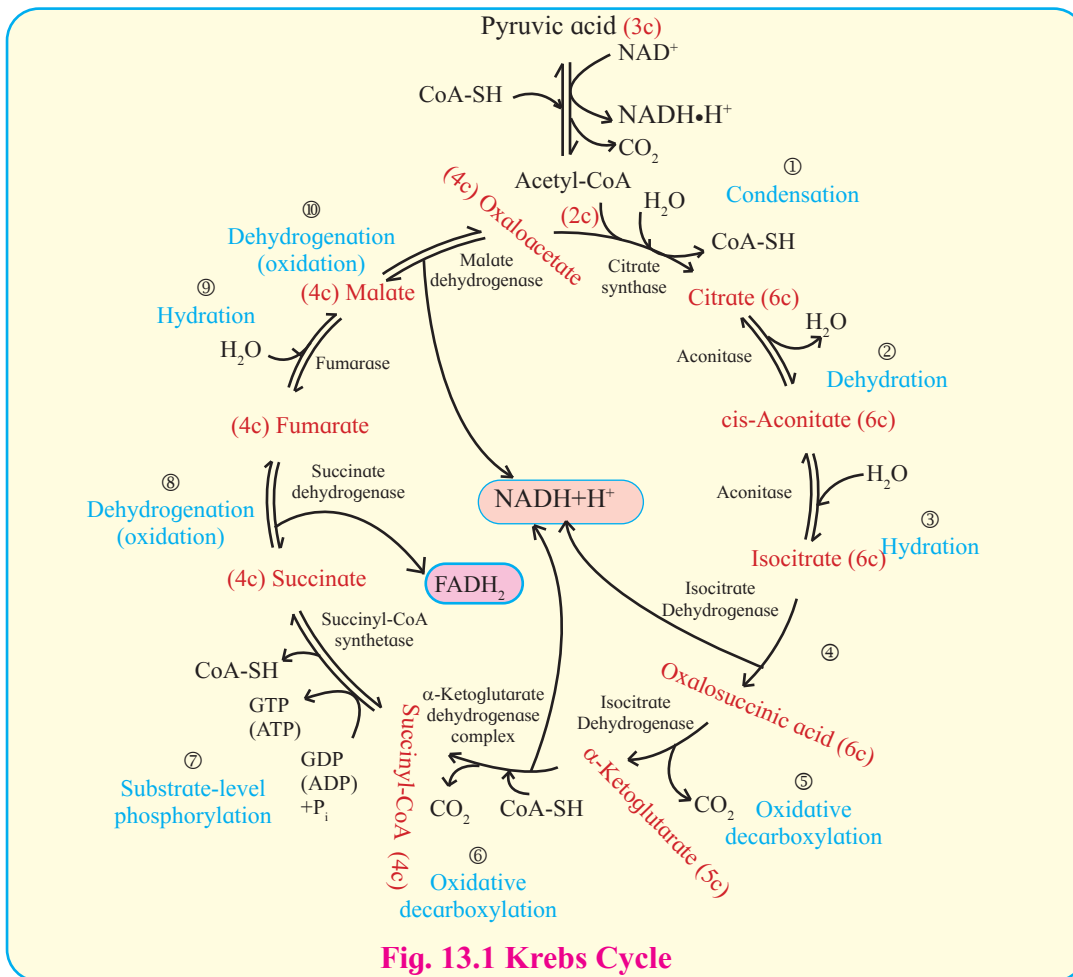
Pyruvate dehydrogenase complex needs thiamin (vitamin  $\text{B}_1$ ) as a co-enzyme. It can not function in absence of vitamin  $\text{B}_1$ . Hence, thiamin deficiency causes pyruvic acidosis and lactic acidosis, the life threatening conditions.

Hence balanced diet is very important in the maintenance of health.

#### Krebs Cycle ( TCA cycle/ Citric Acid Cycle):

Pyruvic Acid produced by glycolysis undergoes aerobic oxidation in the mitochondrial matrix through the TCA cycle. This cycle serves a common oxidative pathway for carbohydrates fats and proteins. Moreover, some intermediates of the TCA cycle are used in synthesizing important biomolecules such as glutamate and aspartate.

Before participating in the TCA cycle pyruvic acid (3c) enters the mitochondrion. Here it is decarboxylated and the remaining 2-carbon fragment is combined with a molecule of coenzyme A to form acetyl-CoA (2c).



**Fig. 13.1 Krebs Cycle**

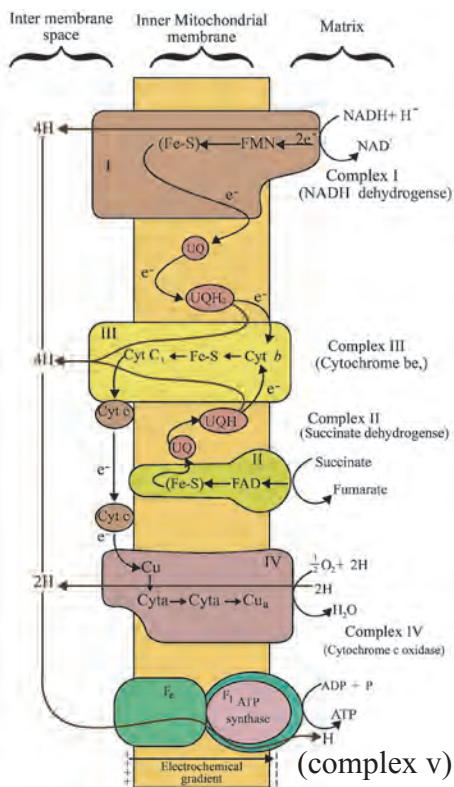
This reaction is an oxidative decarboxylation process and produces H<sup>+</sup> ions and electrons along with carbon dioxide. During the process NAD<sup>+</sup> is reduced to NADH+H<sup>+</sup>. β-oxidation of fatty acids also produces acetyl-CoA as the end product. Acetyl-CoA from both sources is condensed with oxaloacetic acid (4c) to form citric acid (5c). Citric acid is oxidized step-wise by mitochondrial enzymes, releasing carbon dioxide. This finally regenerates oxaloacetic acid to complete the cycle. There are four steps of oxidation in this cycle, catalyzed by dehydrogenases (oxidoreductases) using NAD<sup>+</sup> or FAD<sup>+</sup> as the coenzyme. The coenzymes are consequently reduced to NADH+H<sup>+</sup> and FADH<sub>2</sub> respectively. These transfer their electrons to the mitochondrial respiratory chain to get reoxidised. One molecule of GTP (ATP) is also generated for every molecule of citric acid oxidized.

**Amphibolic Pathway :** Through we describe the aerobic respiration as catabolic (oxidative) pathway; it is not entirely correct; especially in case of Krebs cycle. Various reactions of Krebs cycle are mainly responsible for step-wise oxidation of acetyl part of acetyl CoA leading to the release of energy and CO<sub>2</sub>. However, as per need, acetyl CoA or some other intermediates like α-ketoglutarate, oxaloacetate are used as precursors for synthesis of fatty acids, glutamic acid and aspartic acid respectively. Hence, Krebs cycle can be correctly referred to as a 'Amphibolic pathway' i.e. involving catabolism as well as anabolism.

### Electron Transport chain (Electron transfer system) :

Wherever the NADH<sub>2</sub> (NADH+H<sup>+</sup>) and FADH<sub>2</sub> are produced during glycolysis, connecting link reaction and Krebs cycle, they are oxidised with the help of various electron carriers and enzymes.

These carriers and enzymes are arranged on inner mitochondrial membrane in the form of various complexes as complex I, II, III, IV and V. NADH+H<sup>+</sup> is oxidised by NADH dehydrogenase (complex I) and its electrons are transferred to ubiquinone (coenzyme Q i.e. CoQ) present on inner membrane of mitochondria. Reduced ubiquinone is called as ubiquinol. FADH<sub>2</sub> is oxidised by complex II (Succinate dehydrogenase) and these electrons are also transferred to CoQ. During oxidation of NADH+H<sup>+</sup> and FADH<sub>2</sub>, electrons and protons are released but only electrons are carried forward whereas protons are released into outer chamber of mitochondria.



**Fig. 13.2 Electron Transport system (ETS)**

Ubiquinol is oxidised by complex-III (Cytochrome bc<sub>1</sub> complex) and its electrons are transferred to cytochrome C. Cytochrome C is a small, iron-containing protein, loosely associated with inner membrane. It acts as a mobile electron carrier, transferring the electrons between complex III and IV.

Cytochrome C is oxidised by complex IV or cytochrome C oxidase consisting of cytochrome a and a<sub>3</sub>. Electrons are transferred by this complex to the molecular oxygen. This is terminal oxidation. Reduced molecular oxygen reacts with protons to form water molecule.

Protons necessary for this are channeled from outer chamber of mitochondria into inner chamber by F<sub>0</sub> part of oxysome (complex V) embeded in inner mitochondrial membrane. This proton channeling by F<sub>0</sub> is coupled to catalytic site of F<sub>1</sub> which catalyses the synthesis of ATP from ADP and inorganic phosphate. This is **oxidative phosphorylation**. As transfer of protons is accompanied with synthesis of ATP, this process is named as 'Chemiosmosis' by Peter Mitchell.

Oxidation of one NADH+H<sup>+</sup> leads to production of 3 ATP molecules where as oxidation of FADH<sub>2</sub> leads to production of 2 ATP molecules. However the number of ATP produced depends upon the physiological conditions and source of respiratory substrate.

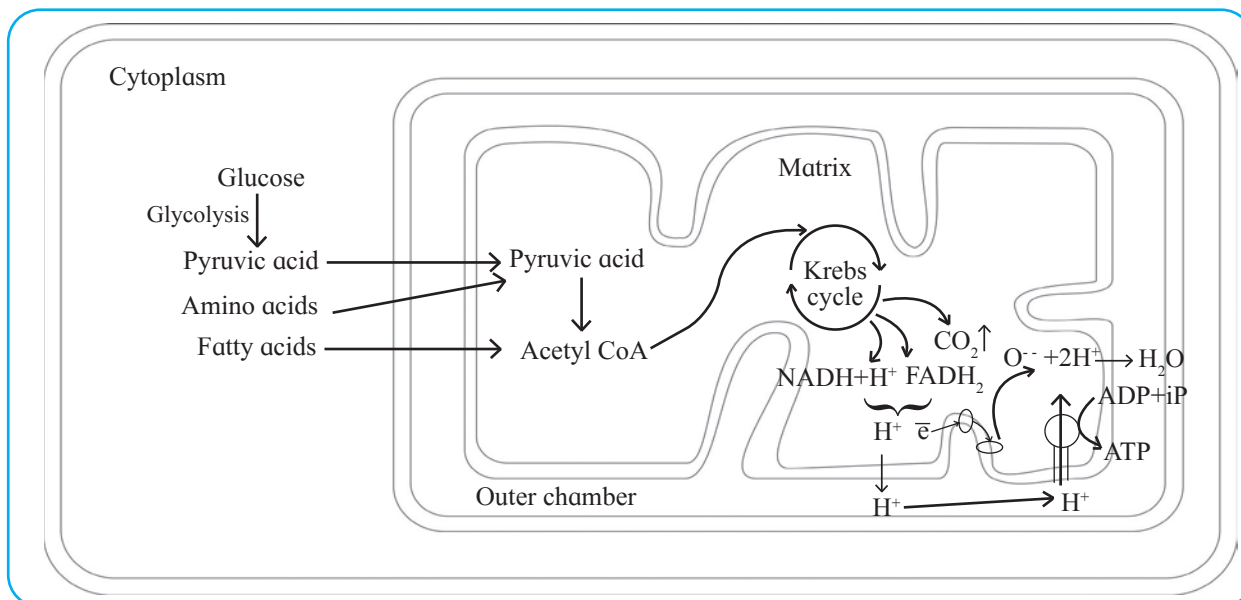


**Internet my friend**

What is effect of carbon monoxide poisoning on cytochromes?

Step of Respiration	Consumption	Production					Total	Net benefit
		Substrate level phosphorylation	Oxidative Phosphorylation					
			NADH+H <sup>+</sup>	FADH <sub>2</sub>	Total			
Glycolysis	2	4	2 x 3 = 6	-----	6	10	8	
Pyruvate → AcetylCoA	-----	-----	2 x 3 = 6	-----	6	6	6	
Krebs cycle	-----	1 x 2 = 2	6 x 3 = 18	2 x 2 = 4	22	24	24	
<b>Total</b>	<b>2</b>	<b>[6]</b>	<b>30 + 4 = [34]</b>			<b>[40]</b>	<b>38</b>	

**Table 13.3 Balance sheet for ATP by aerobic oxidation of 1 glucose molecule**



**Fig. 13.4 Summary of Aerobic Respiration**

### Significance of ETS :

- The electron transport system (ETS) or terminal oxidation generates major amount of energy in the form of ATP molecules, 34 ATP molecules out of total 38 ATP molecules are produced through ETS.
- It regenerates oxidized coenzymes such as  $\text{NAD}^+$  and  $\text{FAD}^+$  from their reduced forms ( $\text{NADH}+\text{H}^+$  and  $\text{FADH}_2$ ) for recycling.
- It also produces water molecules.
- It releases energy in a stepwise manner to prevent damage of cells.



### Always Remember

Not only glucose but amino acids from protein metabolism and fatty acids from lipid metabolism also participate in Krebs cycle through acetyl CoA.



### Try this

**Aerobic respiration can be demonstrated by two simple experiments.**

**A.** A pinch of dry baker's yeast suspended in water or a few ml of yeast suspension used in a bakery is added to about 10ml of 10 percent glucose solution in a test tube (Tube A).

The surface of the liquid is carefully covered with oil to prevent contact with air. The test tube is closed tightly with rubber stopper. One end of a short bent glass tube is inserted through it to reach the air inside the tube. Other end of the glass tube is connected by a polyethylene or rubber tubing to another bent glass tube fitted into a stopper. The open end of the glass tube (delivery tube) is dipped into lime water containing in a test tube (Tube B). Stoppers of both the tubes are fitted tightly to prevent leakage of gases. First test tube is placed in warm water ( $37^\circ\text{C}$ - $38^\circ\text{C}$ ) in a beaker. Lime water gradually turns milky, indicating the evolution of carbon dioxide from the yeast preparation.

Level of the lime water in the delivery tube does not rise, showing that there is no decline in volume of gas in test tube A and consequently no utilization of oxygen by yeast. Preparation is stored for a day or two. When you open the stopper of tube A. You will notice a smell of alcohol indicating the formation of ethanol. From this activity it may be inferred that yeast respire anaerobically to ferment glucose to ethanol and carbon dioxide.

**B.** Seed coats of a few germinating seeds (peas, beans or gram) are removed. Dehulled seeds are then put in a test tube filled with mercury. After closing the test tube with the thumb, it is vertically inverted in a trough of mercury and the thumb is carefully removed. Being lighter than mercury, the seeds rise to the closed upper end of the test tube. No gas is seen at first in the test tube. As germination proceeds, a gas begins to collect at the top of the mercury in the test tube. On introducing a pellet of potassium hydroxide into the tube, it rises to the top and absorbs the gas. The mercury again fills the tube. The potassium hydroxide reacts with carbon dioxide gas to produce potassium carbonate and water.



### Use your brain power

Do the plants breath like animals? If yes, how and why?

The gas therefore disappears. Evidently germinating seeds produce carbon dioxide by anaerobic respiration in the absence of oxygen in the mercury column.

### 13.4 Utility of stepwise oxidation :

You have noted that both anaerobic and aerobic respiration are conducted in many steps. You may wonder what could be the utility of a metabolic pathway with so many steps? Such stepwise metabolism serves several purposes.

- i. A stepwise release of the chemical bond energy facilitates the utilization of a relatively higher proportion of that energy in ATP synthesis.
- ii. Activities of enzymes for the different steps may be enhanced or inhibited by specific compounds. This provides a means of controlling the rate of the pathway and the energy output according to need of the cell.
- iii. The same pathway may be utilized for forming intermediates used in the synthesis of other biomolecules like amino acids.



### Always Remember

Removal of Hydrogen from respiratory materials is the primary process in respiration : The fact that during respiration oxygen is taken in and carbon dioxide is given out may give a false impression that respiratory materials directly unite with oxygen. It must be remembered that oxygen does not play such a primary role in the process of respiration. The primary process in respiration consists in removal of hydrogen from the respiratory materials. The reactions in which hydrogen is removed are catalyzed by enzymes called dehydrogenases as free hydrogen cannot exist in the cell. As soon as it is removed from respiratory material it is picked up by substances known as acceptors. In aerobic respiration this hydrogen is ultimately handed over to oxygen. These two combine with each other and form water.



### Think and Compare

Comparison of overall equations of photosynthesis and respiration show that to some extent, two processes are reverse of each other. Photosynthesis involves reduction of  $\text{CO}_2$  to glucose and respiration involves oxidation of glucose.

### Respiratory Quotient :

Ratio of volume of  $\text{CO}_2$  released to the volume of  $\text{O}_2$  consumed in respiration is called the **respiratory quotient** (RQ) or respiratory ratio. It depends on the type of respiratory substrate.

When carbohydrates are used as respiratory substrate and are completely oxidized, the RQ is 1, because volume of  $\text{CO}_2$  released is equal to volume of  $\text{O}_2$  consumed, as shown in the equation.

When fats or proteins are used as a substrate, the RQ is less than 1, as volume of  $\text{CO}_2$  released is always less than volume of  $\text{O}_2$  consumed.

Mostly for fats, RQ is about 0.7 and for proteins it is about 0.9

In case of anaerobic respiration RQ is always infinity as  $\text{CO}_2$  is evolved without taking  $\text{O}_2$ .

### Significance of Respiration

1. Respiration provides energy for synthesis of biomolecules.
2. It is also a source of energy for cell division, growth, repairs and replacement of worn out parts, movements, locomotion etc.
3. Various intermediates of Krebs cycle are used as building blocks for synthesis of other complex compounds.
4. Coupled with photosynthesis, it helps to maintain the balance between  $\text{CO}_2$  and  $\text{O}_2$  in the atmosphere.
5. Anaerobic respiration (fermentation) is used in various industries such as dairies, bakeries, distilleries, leather industries, paper industries etc. It is used in the commercial production of alcohol, organic acids, vitamins, antibiotics etc.



### Internet my friend

Calculate the RQ for different respiratory substrates using appropriate formula.





## Exercise

### 1. Choose correct option

- A. The reactions of the TCA cycle occur in  
a. ribosomes  
b. grana  
c. mitochondria  
d. endoplasmic reticulum
- B. In eucaryotes the complete oxidation of a molecule of glucose results in the net gain of  
a. 2 molecules of ATP  
b. 36 molecules of ATP  
c. 4 molecules of ATP  
d. 38 molecules of ATP
- C. Which step of Krebs cycle operates substrate-level phosphorylation?  
a.  $\alpha$ -ketoglutarate  $\rightarrow$  succinyl CoA.  
b. Succinyl CoA  $\rightarrow$  succinate  
c. Succinate  $\rightarrow$  fumarate  
d. Fumarate  $\rightarrow$  malate

### 2. Fill in the blanks with suitable words

- A. Acetyl CoA is formed from ..... and co-enzyme A.
- B. In the prokaryotes ..... molecules of ATP are formed per molecule of glucose oxidised.
- C. Glycolysis takes place in .....
- D.  $F_1$ -  $F_0$  particles participate in the synthesis of .....
- E. During glycolysis ..... molecules of  $\text{NADH} + \text{H}^+$  are formed.

### 3. Answer the following questions

- A. When and where does anaerobic respiration occur in man and yeast?
- B. Why is less energy produced during anaerobic respiration than in aerobic respiration?
- C. Which is the site of ETS in mitochondrial respiration?

- D. Which is the terminal electron acceptor in aerobic respiration?
- E. What is RQ.? What is its value for fats?
- F. What are respiratory substrates? Name the most common respiratory substrate.
- G. Write explanatory notes on :  
i. Glycolysis  
ii. Fermentation by yeast  
iii. Electron transport chain
- H. How are glycolysis, TCA cycle and electron transport chain linked? Explain.
- I. How would you demonstrate that yeast can respire both aerobically and anaerobically?
- J. What is the advantage of step wise energy release in respiration?
- K. Explain ETS.
- L. Discuss. "The respiratory pathway is an amphibolic pathway".
- M. Why is Krebs cycle referred as amphibolic pathway?
- N. Which of the following step of aerobic respiration would be omitted when fatty acids are used as respiratory substrate?  
a. Glycolysis  
b. Krebs cycle  
c. Electron transfer chain reaction  
d. Terminal oxidation.

### 4. Compare

- A. Photosynthesis and Respiration.  
B. Anaerobic and Anaerobic respiration.

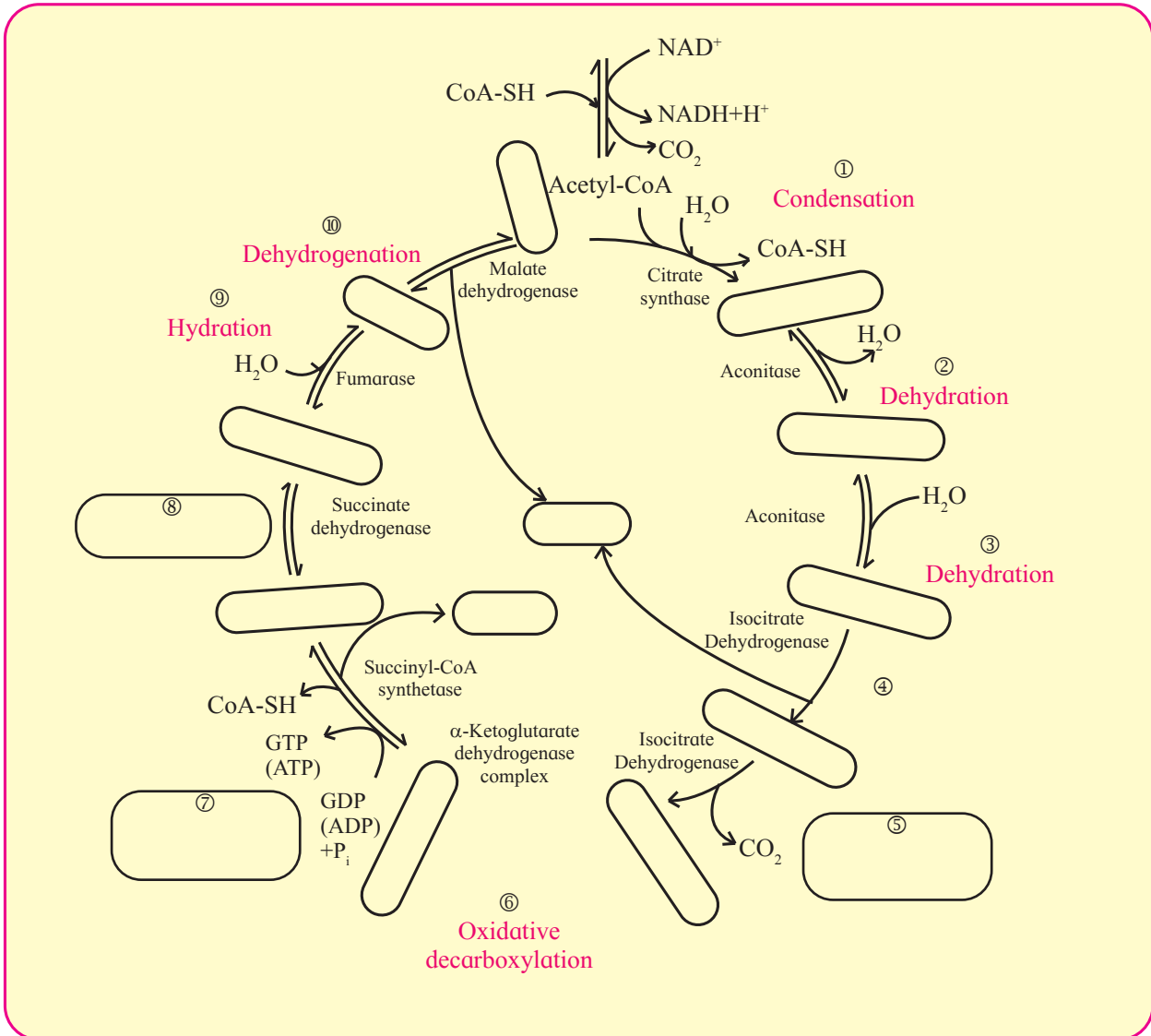
### 5. Differentiate between

- A. Respiration and combustion  
B. Glycolysis and Krebs cycle  
C. Aerobic respiration and fermentation

6. Identify the cycle given below. Correct it and fill in the blanks and write description of it in your own words

**Practical / Project :**

Make Power point Presentation on Glycolysis, Kerbs Cycle and Conduct the group discussion on it, in classroom.



## 14. Human Nutrition



### Can you recall?

1. What is nutrition?
2. Enlist life processes that provide us energy to perform different activities.

Nutrition is the sum of the processes by which an organism consumes and utilises food substances. WHO (World Health Organisation) defines nutrition as the intake of food, considered in relation to the body's dietary needs. The dietary needs of a healthy human being include carbohydrates, proteins, fats, vitamins, minerals, water and fibres in adequate amounts. The term nutrition includes the processes like ingestion, digestion, absorption, assimilation and egestion. Food provides energy and organic material for growth and tissue repair. Vitamins and minerals are also required in small quantities for nutrition. The food that is consumed needs to be processed before it is utilised.



### Think about it

Our diet includes all necessary nutrients. Still we need to digest it. Why is it so?

Digestion is defined as the process by which the complex, non-diffusible and non-absorbable food substances are converted into simple, diffusible and assimilable substances.

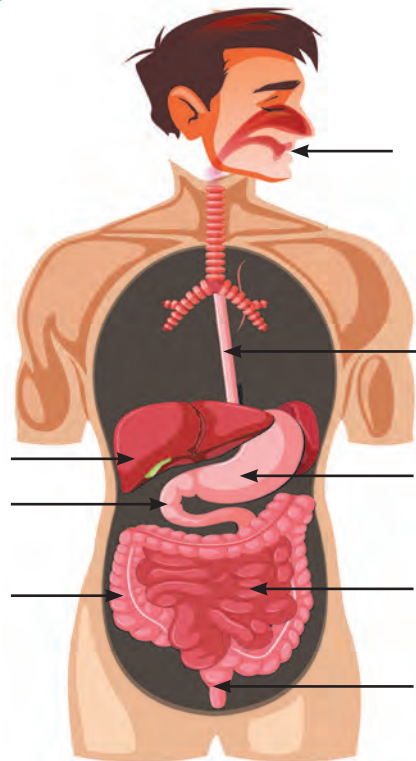
**14.1 Human Digestive System :** Digestive system of man consists of alimentary canal and associated digestive glands.

**Alimentary canal :** It is a long tubular structure starting from mouth and ending with anus. It is about 8-10 meters long and consists of following organs :

**Mouth :** Also called as oral or buccal cavity



### Label the diagram



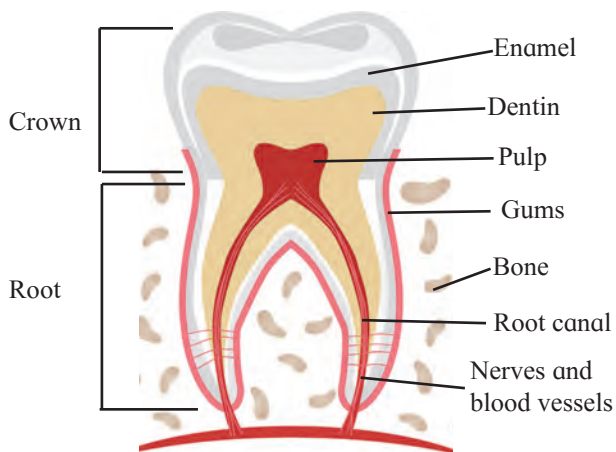
is bounded by fleshy lips. Its side walls are formed of cheeks, roof is formed by palate and floor by tongue. It is internally lined by a mucous membrane. Salivary glands open into the buccal cavity.

**Teeth :** 32 teeth are present in the buccal cavity of an adult human being. Human dentition is described as thecodont, diphyodont and heterodont. It is called thecodont type because each tooth is fixed in a separate socket present in jaw bones by gomphosis type of joint. In our life time, we get only two sets of teeth, milk teeth and permanent teeth. This is called diphyodont dentition. We have four different type of teeth hence we are heterodont. Types of teeth are incisors (I) canines (C) premolars (PM) and molar (M). Each half of each jaw has two incisors, one canine, two premolars and three molars.

**Thus, dental formula of adult human can be represented as.**

$$I \frac{2}{2}, C \frac{1}{1}, PM \frac{2}{2}, M \frac{3}{3} = \frac{2,1,2,3}{2,1,2,3}$$

i.e.  $8 \times 2 = 16$  teeth in each jaw.  $= 32$  teeth



**Fig. 14.1 Tooth Anatomy**



#### Find out

1. What will be the dental formula of a three years old child?
2. What is dental caries and dental plaque? How can one avoid it?



#### Internet my friend

1. Find out the role of orthodontist and dental technician.
2. What is root canal treatment?

A tooth consists of the portion that projects above the gum called crown and the root that is made up of two or three projections which are embedded in gum. A short neck connects the crown with the root. The crown is covered by the hardest substance of the body called enamel. Enamel is made up of calcium phosphate and calcium carbonate. Basic shape of tooth is derived from dentin, a calcified connective tissue. The dentin encloses a cavity called pulp cavity. It is filled with connective tissue pulp. Pulp cavity contains blood vessels and nerves. Pulp cavity has extension in the root of the tooth called root canal. The dentin of the root of tooth is covered by cementum, a bone like substance that attaches the root to the surrounding socket in the gum.

The study of teeth with respect to their number, arrangement, development etc is known as dentition.

**Tongue :** It is a muscular, fleshy organ and roughly triangular in shape. It lies along the floor of the buccal cavity. The upper surface of the tongue bears numerous projections called papillae. Some papillae bear sensory receptors called taste buds.



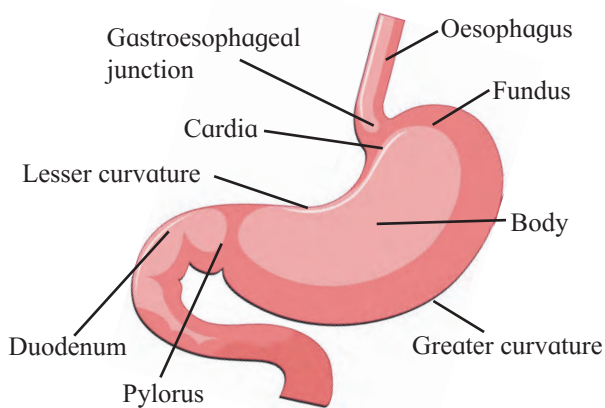
#### Do you know ?

1. Who controls the deglutition?
2. Is deglutition voluntary or involuntary?

**Pharynx :** The buccal cavity leads to a short pharynx. Pharynx is a common passage for food and air. The upper region of pharynx is called trachea. The pharynx opens into trachea through an opening called glottis. The glottis is guarded by a cartilaginous flap called epiglottis. The epiglottis closes during the swallowing (deglutition) action and prevents entry of food into the trachea. The lower region of pharynx is called oropharynx. Oropharynx opens into oesophagus through gullet.

**Oesophagus :** The oesophagus is a thin, muscular tube. It lies behind the trachea. This  $\approx 25$ cm long tube passes through the neck, central aspect of rib cage, pierces the diaphragm and joins the stomach. It is lined by mucus cells. Mucus lubricates the passageway of food. Histologically, oesophagus is made up of longitudinal and circular muscles. The rhythmic wave of contraction and relaxation of these muscles is called peristalsis that helps in passage of food through oesophagus.

**Stomach :** The stomach is located in the upper left portion of the abdominal cavity. It is a muscular sac-like 'J' shaped organ, around 25 to 30cm in length. It is divided into upper cardiac region and lower pyloric region.



**Fig. 14.2 Stomach**

**Cardia or Cardiac :** It is first part in which oesophagus opens. The cardia surrounds the band of circular muscles present at the junction of oesophagus and stomach called cardiac sphincter. The cardiac sphincter prevents back flow or regurgitation of food from stomach to oesophagus.

**Fundus :** It is the dome shaped region above and left of cardia.

**Body :** It forms the large central portion of stomach that stores the food.

**Pylorus :** It is a narrow posterior region of stomach. It opens into duodenum, the initial part of small intestine. This opening is guarded by a set of sphincter muscles called pyloric sphincter. It regulates the flow of food from stomach to small intestine.

The stomach temporarily stores the food and gives the feeling of satiety. It churns the food and helps in mixing the food with gastric juice.

**Small Intestine :** In human, it is about 6 meters long and 2.5 cms broad tube coiled within abdominal cavity. The coils are held together by mesenteries, supporting the blood vessels, lymph vessels and nerves. It is divided into three parts.

**Duodenum :** It is about 26 cm long 'U' shaped structure. The duodenum turns towards left side of abdominal cavity below the stomach.

**Jejunum :** It is about 2.5 meters long, coiled middle portion of small intestine. It is narrower than the duodenum.

**Ileum :** It is about 3.5 meters long. It is highly coiled and little broader than jejunum. The ileum opens into the caecum of large intestine at ileocaecal junction.

**Large Intestine :** Ileum opens into large intestine. It is 1.5 meters in length. It is wider in diameter and shorter than small intestine. It consists of caecum, colon and rectum.

**Caecum :** Caecum is a small, blind sac present at the junction of ileum and colon. It is 6cm in length. It hosts some symbiotic micro-organisms. An elongated worm like vermiform appendix arises from the caecum. Appendix is vestigial organ in human beings and functional in herbivorous animals for the digestion of cellulose.

**Colon :** Caecum opens into colon. Colon is tube like-organ consist of three parts, ascending colon, transverse colon and descending colon. The colon is internally lined by mucosal cells.

**Rectum :** It is posterior region of large intestine. It temporarily stores the undigested waste material called faeces till it is egested out through anus.

**Anus :** Anus is the terminal opening of alimentary canal. It is guarded by sphincter. It expels faecal matter by a process called egestion or defaecation.

## 14.2 Histological structure of alimentary



### Find out

1. What is heart burn? Why do we take antacids to control it?
2. You must have heard of appendicitis. It is inflammation of appendix. Find more information about this disorder.

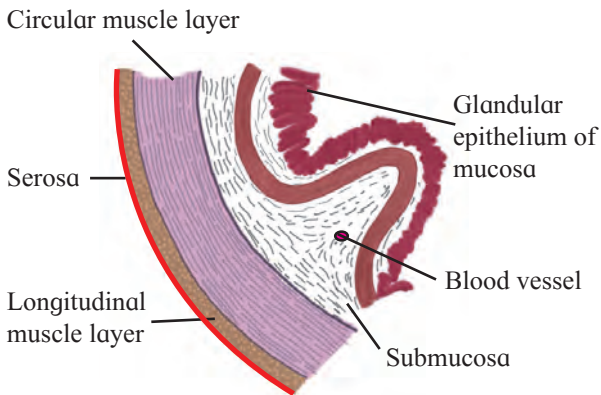


### Activity :

Make a model of human digestive system in a group.

### canal :

The entire gastrointestinal tract is lined by four basic layers from inside to outside namely, mucosa, submucosa, muscularis and serosa. These layers show modification depending on the location and function of the organ concerned.



**Fig. 14.3 Histology of alimentary canal**

**Serosa :** It is the outermost layer. It is made up of a layer of squamous epithelium called mesothelium and inner layer of connective tissue.

**Muscularis :** This layer is formed of smooth muscles. These muscles are usually arranged in three concentric layers. Outermost layer shows longitudinal muscles, middle circular muscles and inner oblique muscles. This layer is wider in stomach and comparatively thin in intestinal region. The layer of oblique muscles is absent in the intestine.

**Submucosa :** It is formed of loose connective tissue containing blood vessels, lymph vessels and nerves. Duodenal submucosa shows presence of glands.

**Mucosa :** The lumen of the alimentary canal is lined by mucosa. Throughout the length of alimentary canal, the mucosa layer shows presence of goblet cells that secrete mucus. This lubricates the lumen of alimentary canal. This layer shows modification in different regions of alimentary canal. In stomach, it is thrown into irregular folds called rugae. In stomach mucosa layer forms gastric glands that secrete gastric juice.

Mucosa of small intestine forms finger like foldings called villi. The intestinal villi are lined by brush border or epithelial cells having microvilli at the free surface. Villi are supplied with a network of capillaries and lymph vessels called lacteals. Mucosa forms crypts in between the bases of villi in intestine called crypts of Lieberkuhn. These are intestinal glands.

### 12.3 Digestive Glands :

The digestive glands associated with the alimentary canal include the salivary glands, liver and pancreas.

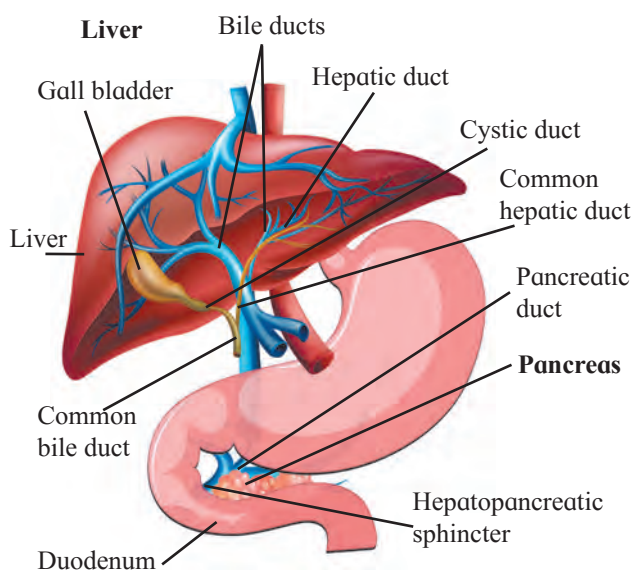
**Salivary glands :** There are three pairs of salivary glands which open in buccal cavity. Parotid glands are present in front of the ear. The submandibular glands are present below the lower jaw. The glands present below the tongue are called sublingual. Salivary glands are made up of two types of cells. Serous cells secrete a fluid containing digestive enzyme called salivary amylase. Mucous cells produce mucus that lubricates food and helps swallowing.

**Liver :** This dark reddish-brown coloured gland is present just below the diaphragm. It occupies the right upper portion of the abdominal cavity. It is the largest gland of the body. It weighs about 1.2 to 1.5 kg in an adult human being. Each lobe of this bilobed gland is covered by thin covering called Glisson's capsule. This capsule is made up of connective tissue. Each lobe is divided into several structural and functional units of liver called hepatic lobules. Each hepatic lobule is polygonal in shape. At the junction of adjacent lobules a triangular portal area is present. In this portal area a branch of each of hepatic artery, hepatic portal vein and bile duct is present.

A lobule consist of cords of hepatic cells which are arranged around a central vein. In between the cords of hepatic cells, spaces called sinusoids are present through which the blood flows. In the sinusoids, phagocytic cells called Kupffer cells are present.

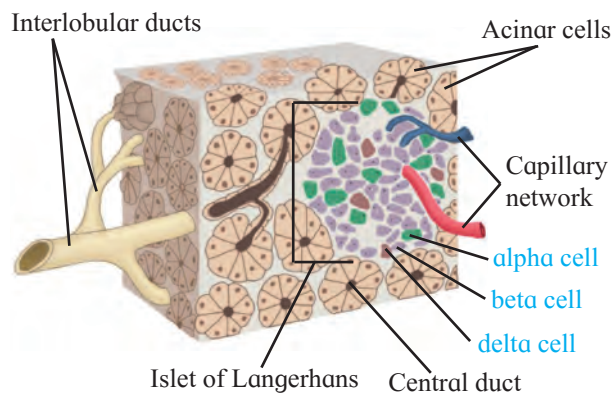
These cells destroy toxic substances, dead and worn-out blood cells and microorganisms. Hepatic cells produce bile juice. It is collected and carried through bile duct and stored in sac like gall bladder. The duct of the gall bladder and hepatic duct together form common bile duct. Liver is a vital organ. Bile juice secreted by liver emulsifies fats and makes food alkaline.

Liver stores excess of glucose in the form of glycogen. Deamination of excess amino acids to ammonia and its further conversion to urea takes place in liver. It is also involved in synthesis of vitamins A, D, K and B<sub>12</sub>. Liver also produces blood proteins like prothrombin and fibrinogen. During early development, liver acts as haemopoietic organ. Kupffer cells help in detoxification process and destruction of old RBCs.



**Fig. 14.3 Liver and Pancreas**

**Pancreas :** Pancreas is a leaf shaped heterocrine gland present in the gap formed by bend of duodenum under the stomach. Exocrine part of pancreas is made up of acini. Acinar cells secrete alkaline pancreatic juice that contains various digestive enzymes. Pancreatic juice is collected and carried to duodenum by pancreatic duct. The common bile duct joins pancreatic duct to form hepato-pancreatic duct. It opens into duodenum. Opening of hepato-pancreatic duct is guarded by sphincter of Oddi.



**Fig. 14.4 Histological structure of Pancreas**

Endocrine part of pancreas is made up of groups of cells called islets of Langerhans present between the acini. Islets contain three types of cells.  $\alpha$ -cells secrete glucagon,  $\beta$ -cells secrete insulin and somatostatin hormone is secreted by  $\delta$ -cells. Glucagon and insulin together control the blood-sugar level. Somatostatin hormone inhibits glucagon and insulin secretion.



**Use your brain power**

1. Draw a neat labelled diagram of human alimentary canal and associated glands *in situ*.
2. Write a note on human dentition.
3. Liver is a vital organ. Justify.
4. Muscularis layer in stomach is thicker than that in intestine. Why is it so?

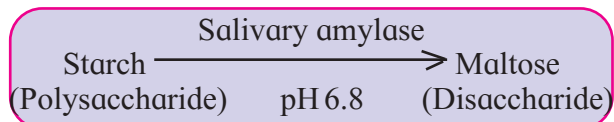
**12.4 Physiology of digestion :**

We are already aware that food we consume needs to be processed in order to utilise it completely. Physiology of digestion includes various processes involved in simplification of food. Digestion process is carried out by both mechanical as well as biochemical methods. Mechanical digestion includes various movements of alimentary canal that help chemical digestion. Mastication or chewing of food by teeth, churning in stomach and peristaltic movements of gastrointestinal tract bring about mechanical digestion in human body.

Chemical digestion is a series of catabolic (breaking down) reactions that hydrolyse the food. Let us now study the process of digestion from the point where it enters the body i.e. mouth.

**Digestion in the buccal cavity :** Both mechanical and chemical digestion processes take place in mouth. Mastication or chewing of food takes place with the help of teeth and tongue. Teeth crush and grind the food. Tongue manipulates the food. Crushing of food becomes easier when it gets moistened by saliva. Mucus in the saliva lubricates the food as well as it helps in binding the food particles into a mass of food called bolus. The bolus is swallowed by deglutition. The tongue presses against the palate and pushes the bolus into pharynx. Bolus further passes to the oesophagus.

The saliva contains 98% water and 2% other constituents like electrolytes (sodium, potassium, calcium, chloride, bicarbonates), digestive enzyme salivary amylase. The only chemical digestion that takes place in mouth is by the action of salivary amylase. It helps in conversion of starch into maltose. About 30% starch gets converted to maltose in mouth.

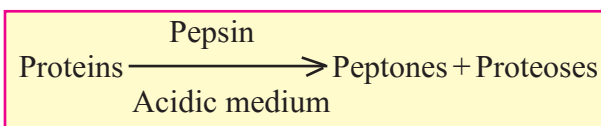
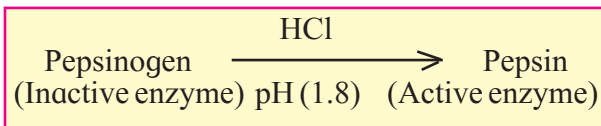


Saliva also contains lysozyme. It acts as an antibacterial agent that prevents infections. The bolus further passes down through the oesophagus by peristalsis. Sometimes regurgitation or vomiting takes place due to reverse spasmodic peristalsis. Food from the oesophagus enters the stomach. The gastro-oesophageal sphincter controls the passage of food into the stomach.

**Digestion in the stomach :** Both mechanical and chemical digestion takes place in stomach. The stomach stores the food for 4-5 hours. The physical digestion happens by churning of food. Thick muscular wall of stomach helps churning process. Churning further breaks down the food particles and also helps in thorough mixing of gastric juice with food.

The mucosa layer of stomach has gastric gland. Each gastric glands has three major types of cells namely, mucus cells, peptic or chief cells and parietal or oxyntic cells. Mucus cells secrete mucus. Peptic cells secrete proenzyme pepsinogen. Parietal cells secrete HCl and intrinsic factor which is essential for absorption of vitamin B<sub>12</sub>. Thus, gastric juice contains mucus, inactive enzyme pepsinogen, HCl and intrinsic factor. In infants, stomach also secretes rennin. Mucus protects the inner lining of stomach from HCl present in gastric juice.

HCl in gastric juice makes the food acidic and stops the action of salivary amylase. It kills the germs that might be present in the food. Pepsinogen gets converted into active enzyme pepsin in the acidic medium provided by HCl. In presence of pepsin, proteins in the food get converted into simpler forms like peptones and proteoses.



### Always Remember

Food remains for a very short time in mouth but action of salivary amylase continues for further 15 to 30 minutes till gastric juice mixes with food in the stomach. Why do you think it stops after the food gets mixed with gastric juice?



Rennin found in gastric juice of infants acts on casein, a protein present in milk. It brings about curdling of milk proteins with the help of calcium. The coagulated milk protein is further digested with the help of pepsin. Rennin is absent in adults. At the end of gastric digestion, food is converted to a semifluid acidic mass of partially digested food is called chyme.

The chyme from stomach is pushed in the small intestine through pyloric sphincter for further digestion.



#### Internet my friend

1. What is lactose intolerance?
2. How are bile pigments formed?

**Digestion in the small intestine :** In the small intestine, intestinal juice, bile juice and pancreatic juice are mixed with food. Peristaltic movements of muscularis layer help in proper mixing of digestive juices with chyme. Bile juice and pancreatic juice are poured in duodenum through hepato-pancreatic duct.

Bile juice is dark green coloured fluid that contains bile pigments (bilirubin and biliverdin), bile salts (Na-glycocholate and Na-taurocholate), cholesterol and phospholipid. Bile does not contain any digestive enzyme. Bile salts neutralise the acidity of chyme and make it alkaline. It brings about emulsification of fats. It also activates lipid digesting enzymes or lipases. Bile pigments impart colour to faecal matter.

Pancreatic juice secreted by pancreas contains pancreatic amylases, lipases and inactive enzymes trypsinogen and chymotrypsinogen. Pancreatic juice also contains nucleases- the enzymes that digest nucleic acids. The intestinal mucosa secretes digestive enzymes. The goblet cells of mucosa produce mucus. Mucus plus intestinal enzymes together constitute intestinal juice or succus entericus. The intestinal juice contains various enzymes like dipeptidases, lipases, disaccharidases etc.

Both pancreatic and intestinal lipases initially convert fats into fatty acid and diglycerides.

Diglycerides are further converted to monoglycerides by removal of fatty acid from glycerol. The mucus and bicarbonates present in pancreatic juice protect the intestinal mucosa and provide alkaline medium for enzymatic action. Sub-mucosal Brunner's glands help in the action of goblet cells. Most of the digestion gets over in small intestine. Let us study the action of pancreatic and intestinal secretion in sequential manner.



#### Think about it

How can I keep my pancreas healthy?  
Can a person live without pancreas?



#### Do you know ?

Why do we feel hungry? Ghrelin is a hormone that is produced mainly by the stomach and small intestine, pancreas and brain. It is known as the 'hunger hormone' because it stimulates appetite, increases food intake and promotes fat storage.

#### Action of pancreatic juice :

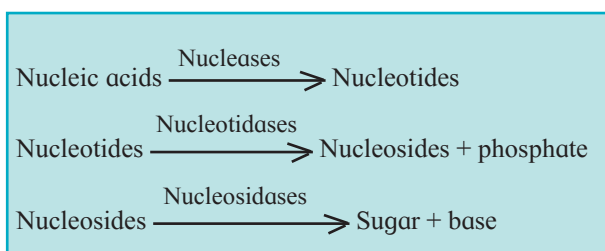
Pancreatic amylase acts on glycogen and starch and convert those to disaccharides. Lipases hydrolyse fat molecules into fatty acids and monoglycerides. Inactive trypsinogen present in pancreatic juice is converted to its active form, trypsin. This conversion is brought about by enterokinase present in intestinal juice. Trypsin converts proteins as well as proteoses and peptones to polypeptides. It also converts chymotrypsinogen to active chymotrypsin. Chymotrypsin converts polypeptides to dipeptides.



#### Do it yourself

You have studied the representation of enzymatic actions in the form of reactions. Write the reactions of pancreatic enzymes.

Nucleases present in pancreatic juice help in digestion of nucleic acids to pentose sugar and nitrogenous base.

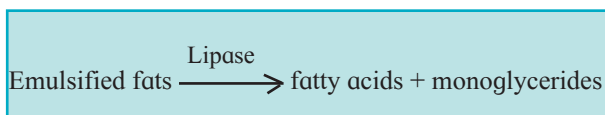
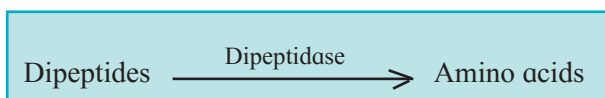
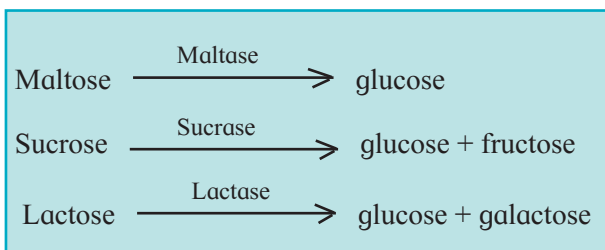


### Action of intestinal juice :



#### Do it yourself

Observe the following reactions and explain in words.



Conversion of proteins into amino acids, fats to fatty acids and monoglycerides, nucleic acids to sugar and nitrogenous base and carbohydrates to monosaccharides marks the end of digestion of food. Food is now called chyle. Chyle is an alkaline slurry which contains various nutrients ready for absorption. The nutrients are absorbed and undigested remains are transported to large intestine.

Remember, mucosa of large intestine produces mucus but no enzymes. Some carbohydrates and proteins do enter the large intestine. These are digested by the action of bacteria that live in the large intestine. Carbohydrates are fermented by bacterial action and hydrogen, carbon dioxide and methane gas are produced in colon.

Protein digestion in large intestine ends up into production of substances like indole, skatole and  $H_2S$ . These are the reason for the odour of faeces. These bacteria synthesise several vitamins like B vitamins and vitamin K.

It is essential that the digestive enzymes and juices are produced in sequential manner and at a proper time. These secretions are under neurohormonal control. Sight, smell and even thought of food trigger saliva secretion. Tenth cranial nerve stimulates secretion of gastric juice in stomach. Even the hormone gastrin brings about the same effect. You must have experienced hunger pangs at your regular meal times. Can you now reason out why it happens? Intestinal mucosa produces hormones like secretin, cholecystokinin (CCK) and gastric inhibiting peptide (GIP). Secretin inhibits secretion of gastric juice. It stimulates secretion of bile juice from liver, pancreatic juice and intestinal juice. CCK brings about similar action and induces satiety that is feeling of fullness or satisfaction. GIP also inhibits gastric secretion.



#### Do you know ?

Pancreatitis is inflammation of the pancreas. It may occur due to alcoholism and chronic gallstones. Other reasons include high levels of calcium, fats in blood. However, in 70% of people with pancreatitis, main reason is alcoholism.

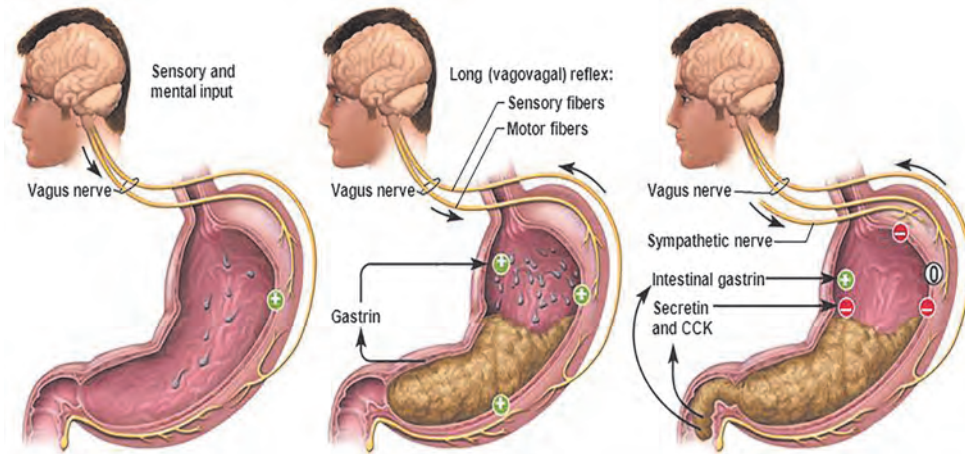


#### Use your brain power

1. Make a flow chart for digestion of carbohydrate.
2. What is a proenzyme? Enlist various proenzymes involved in process of digestion and state their function.
3. Differentiate between chyme and chyle.
4. Digestion of fats take place only after the food reaches small intestine. Give reason.

**Observe and Discuss**

Action of digestive juice in your group.

**Fig. 14.5 Regulation of gastric function****14.5 Absorption, assimilation and egestion:**

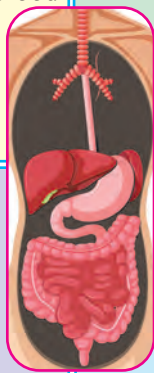
The passage of end products of digestion through the mucosal lining of alimentary canal into blood and lymph is called absorption. Absorption takes place by various ways like simple diffusion, osmosis, facilitated transport and active transport. About 90% of absorption takes place in the small intestine and the rest in mouth, stomach and large intestine.

**Mouth:** Absorption takes place through mucosa of mouth and lower side of tongue into the blood capillaries. e.g. Some drugs like certain painkillers.

**Small Intestine:** Glucose, fructose, galactose, amino acids, minerals and water soluble vitamins are absorbed in blood capillaries in villi. Lipids and fat soluble vitamins (A, D, E, K) are absorbed in lacteals.

**Stomach:** Gastric mucosa is impermeable to most substances hence nutrients reach unabsorbed till small intestine. Little water, electrolytes, alcohol and drugs like aspirin get absorbed in stomach.

**Large intestine:** Absorption of water, electrolytes like sodium and chloride, drugs and some vitamins takes place.



Absorption of part of glucose, amino acids and some electrolytes like chloride ions are absorbed by simple diffusion depending on concentration gradient.

Some amino acids as well as substances like fructose are absorbed by facilitated transport. In this method, carrier ions like  $\text{Na}^+$  bring about absorption. Some ions are absorbed against concentration gradient. It requires energy. This type of absorption of mineral like sodium is called active transport. Water is absorbed along the concentration gradient.

Monoglycerides and fatty acids can not be absorbed in blood. These dissolve in the centre of spherical aggregates formed by bile salts called micelles. Micelles enter into intestinal villi. Here, they are reformed into chylomicrons. Chylomicrons are small protein coated fat globules. They are transported into lymph vessels called lacteals. From here, they are transported to blood stream.

**Observe the adjacent chart to find out absorption in various parts of alimentary canal.**

**Assimilation :** The absorbed food material finally reaches the tissue and becomes a part of protoplasm. This is called as assimilation.

**Absorption of nutrients in alimentary canal**

**Egestion** : Undigested waste is converted to faeces in colon and reaches rectum. Faeces contain water, inorganic salts, sloughed of mucosal cells, bacteria and undigested food. Distension of rectum stimulates pressure sensitive receptors that initiate a neural reflex for defecation or egestion. It is a voluntary process that takes place through anal opening guarded by sphincter muscles.



### Can you recall?

1. What is balanced diet?
2. Explain the terms undernourished, overnourished and malnourished in details.



### Do you know ?

Now a days we talk about calories of food we consume. What is this calorie? The amount of heat liberated by complete combustion of 1g food in a bomb calorimeter is termed as gross calorific (gross energy) value. In animals, the energy content of food is expressed in terms of heat energy. The actual energy produced by 1g food is its physiological value.

Actual energy produced by 1 gm of food.

S r . No.	Food Component	Gross calorific value (Kcal/g)	Physiological value (Kcal/g)
1.	Fats	9.45	9.0
2.	Proteins	5.65	4.0
3	Carbohydrates	4.1	4.0

## 14.6 Nutritional disorders and disorders of digestive system :

Nutrition related disorders can be categorised based on the food that an individual consumes and conditions that develop due to malfunctioning of the organ/s or glands associated with digestive system.

You are already aware that little extra or less of nutrition can lead to dietary disorder. Inadequate intake of proteins causes Protein Energy Malnutrition (PEM). It can be associated with inadequacy of vitamins and minerals in diet. PEM can cause diseases like Kwashiorkar and Marasmus.

**Kwashiorkar** : This protein deficiency disorder is found generally in children between one to three years of age. Children suffering from Kwashiorkar are underweight and show stunted growth, poor brain development, loss of appetite, anaemia, protruding belly, slender legs, bulging eye, oedema of lower legs and face, change in skin and hair colour.

**Marasmus** : It is a prolonged protein energy malnutrition (PEM) found in infants under one year of age. In this disease, protein deficiency is coupled with lower total food calorific value. Inadequate diet impairs physical growth and retards mental development, subcutaneous fat disappears, ribs become prominent, limbs become thin, skin becomes dry, thin and wrinkled, loss of weight, digestion and absorption of food stops due to atrophy of digestive glands. There is no oedema.

Major cause of these disorders is unavailability of nutritious food. Poverty, large family size, ill spacing of children, early termination of breast feeding and overdiluted milk are a few causes. Because of malnutrition, infectious diseases become opportunistic and it worsens the condition. Proper diet can help in reversal of symptoms.

**Indigestion** : Overeating, inadequate enzyme secretion, spicy food, anxiety can cause discomfort and various symptoms. It is called indigestion. Improperly digested food or food poisoning also can cause indigestion. It leads to loss of appetite, acidity (acid reflux), heart burn, regurgitation, dyspepsia (upper abdominal pain), stomach pain.

Avoiding eating large meal, lying down after meal, spicy, oily, junk food, smoking, alcohol are the preventive measures for indigestion.

**Constipation :** When frequency of defaecation is reduced to less than once per week the condition is called constipation. Difficulty in defaecation may result in abdominal pain distortion, rarely perforation. The causes are, affected colonic mobility due to neurological dysfunction like spinal cord injury, low fibre diet, inadequate fluid intake and inactivity. Roughage, sufficient fluids in diet, exercise can help improve the conditions.

**Diarrhoea :** Passing loose watery stools more than three times a day is called diarrhoea. Diarrhoea can lead to dehydration. The other symptoms are blood in stool, nausea, bloating, fever depending on cause and severity of the disorder. The causes of diarrhoea are infection through food and water or disorders like ulcer, colitis, inflammation of intestine or irritable bowel syndrome.

**Jaundice :** We all associate jaundice with yellowness of conjunctiva of eyes and skin and whitish stool. These are the symptoms of condition called jaundice. It is a sign of abnormal bilirubin metabolism and excretion. Jaundice develops if excessive break down of red blood cells takes place along with increased bilirubin level than the liver can handle or there is obstruction in the flow of bile from liver to duodenum. Bilirubin produced from breakdown of haemoglobin is either water soluble or fat soluble. Fat soluble bilirubin is toxic to brain cells. Hence serum bilirubin values have great diagnostic importance. There is no specific treatment to jaundice. Supportive care, proper rest are the treatments given to the patient.

**Vomiting :** In this condition, the stomach contents are thrown out of the mouth due to reverse peristaltic movements of gastric wall. It is controlled by non-vital vomiting centre of medulla. It is typically associated with nauseatic feeling.



### Find out

1. Find out the status of malnutrition among children in Maharashtra and efforts taken by the government to overcome the situation. Search for various NGOs working in this field.
2. Are jaundice and hepatitis same disorders?



### Do you know ?

Alcoholism causes different disorders of liver like steatosis (fatty liver), alcoholic hepatitis, fibrosis and cirrhosis.

Collect more information on these disorders and try to increase awareness against alcoholism in society.

Collect information about NGOs working against alcoholism.



### Know the scientists

K a m a l a Sohoni was the first Indian woman to receive Ph.D. in science discipline. She worked under the guidance of Dr. Robert Hill and discovered 'Cytochrome C', the electron carrier in mitochondria from potato.



Dr. Sohoni also worked on nutritional aspects of legumes, milk and neera. Her contribution was significant in terms of India's fight against malnutrition. She had designed a protocol for Aarey dairy to avoid curdling of milk.



### Internet my friend

Collect the different videos of functioning of digestive system.



## Exercise

### 1. Choose correct option

- A. Acinar cells are present in .....  
 a. liver                      b. pancreas  
 c. gastric glands    d. intestinal glands
- B. Which type of teeth are maximum in number in human buccal cavity?  
 a. Incisors                      b. Canines  
 c. Premolars                      d. Molars
- C. Select odd one out on the basis of digestive functions of tongue.  
 a. Taste    b. Swallowing  
 c. Talking    d. Mixing of saliva in food
- D. Complete the analogy:  
 Ptyalin: Amylase    :    :    Pepsin :  
 .....  
 a. Lipase                      b. Galactose  
 c. Proenzyme                      d. Protease

### 2. Answer the following questions

- A. For the school athletic meet, Shriya was advised to consume either Glucon-D or fruit juice but no sugarcane juice. Why it must be so?
- B. Alcoholic people may suffer from liver disorder. Do you agree? Explain your answer.
- C. Digestive action of pepsin comes to a stop when food reaches small intestine. Justify.
- D. Small intestine is very long and coiled. Even if we jump and run, why it does not get twisted? What can happen if it gets twisted?

### 3. Write down the explanation

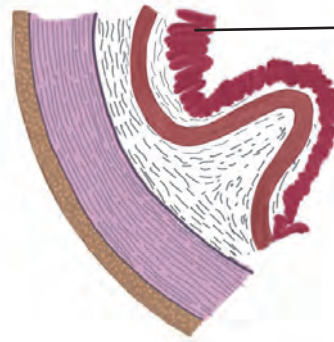
- A. Digestive enzymes are secreted at appropriate time in our body. How does it happen?
- B. Explain the structure of tooth. Explain why human dentition is considered as thecodont, diphydont and heterodont.

- C. Explain heterocrine nature of pancreas with the help of histological structure.

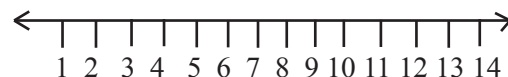
### 4. Write short note on

- A. Position and function of salivary glands.  
 B. Jaundice

### 5. Observe the diagram. This is histological structure of stomach. Identify and comment on significance of the layer marked by arrow

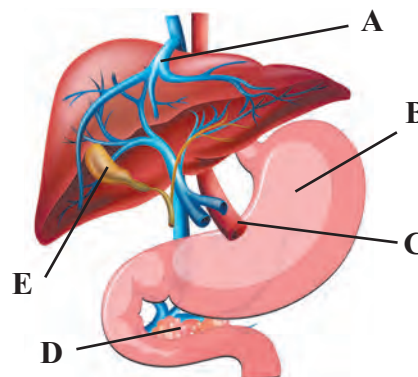


### 6. Find out pH maxima for salivary amylase, trypsin, nucleotidase and pepsin and place on the given pH scale

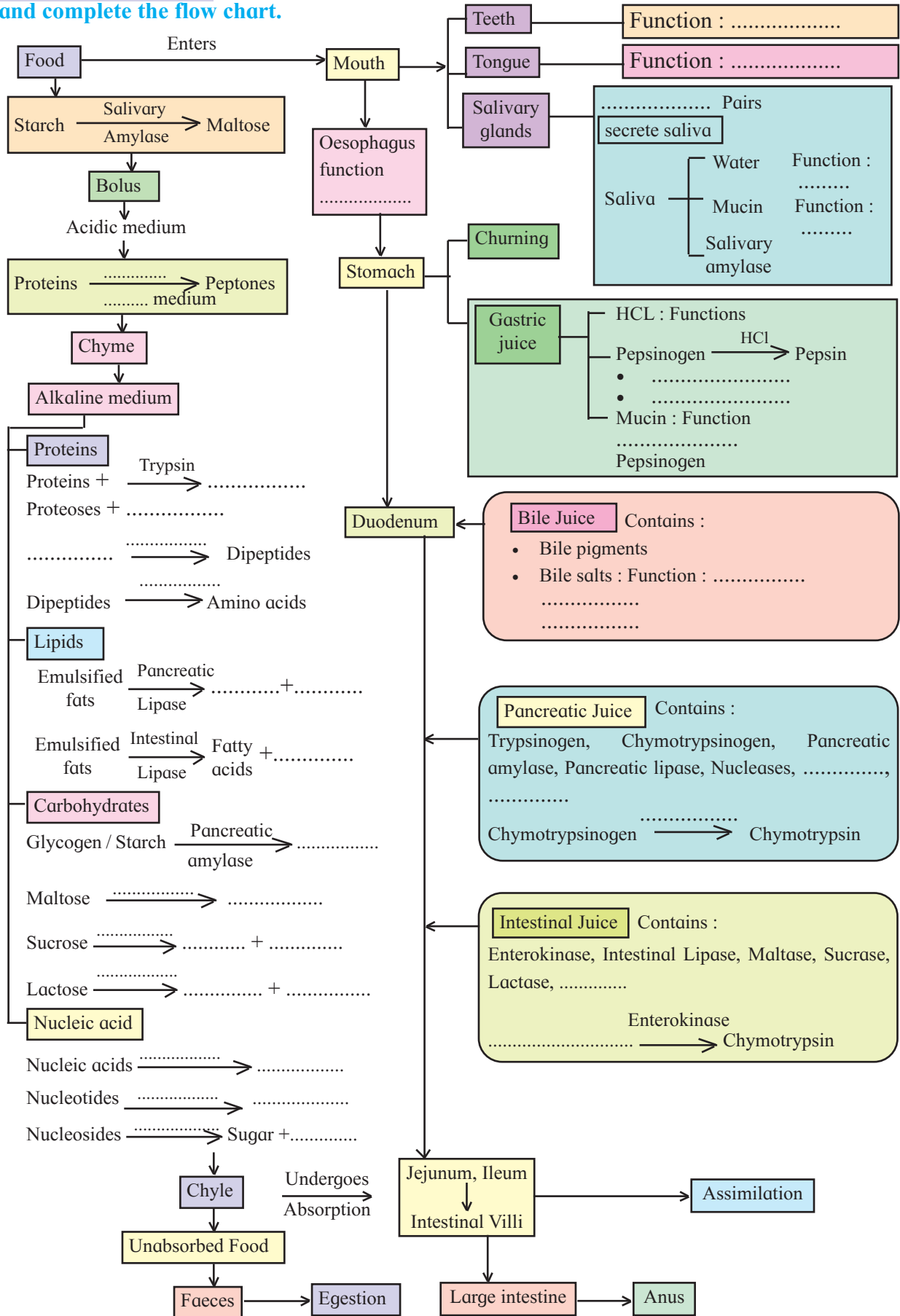


### 7. Write the name of a protein deficiency disorder and write symptoms of it.

### 8. Observe the diagram given below label the A, B, C, D, E and write the function of A, C in detail.



**Practical / Project :** Here are the events in the process of digestion. Fill in the blanks and complete the flow chart.



## 15. Excretion and Osmoregulation



### Can you recall?

1. Why are various waste products produced in the body of an organism ?
2. How are these wastes eliminated ?

Array of chemical processes occur in the body of an organism. Sum total of these processes is called 'metabolism'. Metabolism involves catabolic (breaking down) and anabolic (building up) processes. Metabolism produces a variety of by-products, some of which need to be eliminated. Such byproducts are called metabolic 'waste products'.

Metabolic waste products might be fluid, gaseous, organic or inorganic. Depending on the type, they are eliminated through various organs of the body of an organism.

### 15.1 Excretion and excretory products :

Elimination of metabolic waste products from the body is called excretion. Unlike digestive wastes, which are primarily composed of unabsorbed or undigested substances that have never entered the cells, metabolic wastes are produced inside body cells.

Let us try to enlist various excretory waste products produced in human body; Fluids such as water, gaseous wastes like  $\text{CO}_2$ , nitrogenous wastes like ammonia, urea and uric acid, creatinine, mineral, salts of sodium, potassium, calcium, etc. which if, are present in body in excess are excreted through urine, faeces and sweat. Pigments formed due to breakdown of haemoglobin are like bilirubin (excreted through faeces) and urochrome (eliminated through urine). Also, the pigments present in foodstuff like beet root consumed by organism, excess of vitamins, hormones and drugs taken are eliminated. Spices we consume contain volatile substances that are excreted through lungs.

### Have you ever observed ?

1. When does urine appear deeply coloured?
2. If we consume onion and garlic, we get bad breath. Why?



### Think about it

1. Do organisms differ in type of metabolic wastes they produce?
2. Do environment or evolution have any effect on type of waste produced by an organism?
3. How do thermoregulation and food habits affect waste production ?

Body of an organism can store excess carbohydrates and fats but is unable to store excess amino acids. Hence, excess amino acids are essentially broken down by a process called as deamination. In this process, amino group is separated from the amino acid and ammonia is formed. Toxic ammonia is either excreted as it is or further converted to less toxic forms like urea or uric acid before excretion.

There is no clear correlation between the phylogenetic relationship of organisms and their major excretory products, but it's habitat has. e.g. Tadpole of frog excretes ammonia and adult frogs mostly are ureotelic. Some terrestrial turtles excrete uric acid whereas others excrete urea or ammonia.

Animals can be broadly classified into three types based on nitrogenous wastes they produce : Ammonia is the basic product of deamination process. But it is highly toxic. Hence, it is to be diluted immediately. If there is no or limited access to water, need for conversion of ammonia becomes necessary. Thus, availability of water plays key role in deciding mode of excretion of an organism. These are of mainly three types :





### Think about it

Endotherms consume more food in order to meet energy requirements. Also, carnivorous diet contains more proteins than herbivorous. Does it affect excretion of nitrogenous waste ?

**Ammonotelism** : Elimination of nitrogenous wastes in the form of ammonia is called as ammonotelism. It is basic in nature. Hence, it would disturb pH of body, if retained. Slight increase in pH would disturb all enzyme-catalyzed reactions in body and would also make the plasma membrane unstable. It is readily soluble in water and needs large quantity of water to dilute and reduce the toxicity. However, it is energy saving mechanism of excretion. Hence all animals that have plenty of water available for dilution of ammonia, excrete nitrogenous wastes in the form of ammonia. Such animals are called ammonotelic. 1 gm ammonia needs about 300 – 500 ml of water for elimination.

Ammonotelism is found in aquatic invertebrates, bony fishes, and aquatic / larval amphibians. Animals without excretory system are also ammonotelic. e. g. Protozoa  
Ammonotelic animals excrete ammonia through general body surface (skin), gills and kidneys.

**Ureotelism** : Elimination of nitrogenous wastes in the form of urea ( $\text{H}_2\text{N}-\text{CO}-\text{NH}_2$ ) is called as ureotelism. Urea is less toxic and less water-soluble than ammonia. Hence it can be concentrated to some extent in body. Due to this, it requires less water for elimination. (Compared to ammonia, about 100 time less water in human, several hundred times in camel, kangaroo rat and shark). As it is less toxic and less water soluble; hence, ureotelism is suitable for animals those need conservation of water to some extent. Hence it is common in terrestrial animals, as they have to conserve  $\text{H}_2\text{O}$ . It takes about 50 ml  $\text{H}_2\text{O}$  for removal of 1 gm  $\text{NH}_2$  in form of urea. Mammals, cartilaginous fishes (sharks and rays), many aquatic reptiles, most of the adult amphibians, etc. are ureotelic. They convert ammonia to urea in liver by operating

ornithine / urea cycle (Krebs and Hansleit, 1932). 3 ATP molecules are used to produce one molecule of urea.

Sharks retain more urea in their body fluid (blood) to make their blood isotonic to surrounding marine water. This helps them to prevent possible loss of water by exosmosis.

**Uricotelism ( $\text{C}_5\text{H}_4\text{O}_3\text{N}_4$ )** : Elimination of nitrogenous wastes in the form of uric acid is called as uricotelism. Uric acid is least toxic. Hence, it can be retained in the body for some time in concentrated form. It is least soluble in water. Hence minimum (about 5—10 ml for 1 gm) or no need of water for its elimination. Hence, animals those need to conserve more water follow uricotelism. Ammonia is converted into uric acid by ‘inosinic acid pathway’ in the liver of birds. Birds, some insects, many reptiles, land snails, are uricotelic; because they need to conserve the water. However, they have to spend more energy.



### Use your brain power

Why ammonia is highly toxic?



### Always Remember

Animals like spiders, scorpions and penguins excrete guanine. This mode of excretion is called guanotelism.



### Find out

You will study about a type of arthritis called gouty arthritis caused due to accumulation of uric acid in joints. Where does uric acid comes from in case of ureotelic human beings?



## Observe and Discuss

These are blood reports of patients undergoing investigations for kidney function. What is creatinine ? What is your observation and opinion about the findings ? Why is it used as an index of kidney function?

### Report A

**PERFECT PATHOLOGY** Reg. No. :- \_\_\_\_\_  
 Dr. \_\_\_\_\_ Date :- \_\_\_\_\_  
 Patient name :- \_\_\_\_\_ Age :- \_\_\_\_ M/F  
 Reference :- Dr. \_\_\_\_\_

Examination of Blood		
Test	Result	Normal values
Creatinine	1.92	Male : 0.6 to 1.4 mg/dl. Female : 0.6 to 1.2 mg/dl.

### Report B

**PERFECT PATHOLOGY** Reg. No. :- \_\_\_\_\_  
 Dr. \_\_\_\_\_ Date :- \_\_\_\_\_  
 Patient name :- \_\_\_\_\_ Age :- \_\_\_\_\_  
 M/F  
 Reference :- Dr. \_\_\_\_\_

Examination of Blood		
Test	Result	Normal values
Fasting blood sugar	185	70 - 110 ml/dl

Chemical Examination of Urine		
Test	Result	Normal values
Sugar	Present ++	Absent

Plasma creatinine is produced from catabolism of creatinine phosphate during skeletal muscle contraction. It provides ready source of high energy phosphate. Normally blood creatinine levels remain steady because the rate of production matches it's excretion in urine. Hence, level above normal is an indication of poor renal function.

Excretory organs play an important role in maintenance of constant internal environment of the body called homeostasis. It requires osmoregulation, the process of controlling solute concentrations and water balance. It can be rightly said that composition of blood (and internal environment) is determined not by what mouth ingests but by what excretory organs retain.

Marine birds like Albatross spend their life on the sea. That means water, they drink is salty ! How do they manage osmoregulation then?

They have special glands called salt glands near nostrils. These are capable of secreting salts by active transport and help to manage osmotic balance. Many marine organisms like sea turtles and marine iguanas also have such salt excreting glands.

Animals can either be isoosmotic to the surrounding (osmoconformers) or control internal environment independent of external environment (osmoregulators). Marine organisms mostly are osmocomformers because their body fluids and external environment are isoosmotic in nature.

Fresh water forms and terrestrial organisms are osmoregulators.



### Think about it

During summer, we tend to produce less urine, why is it so ?



### Use your brain power

What would happen if human being has no option but to drink sea water ?



### Think about it

Like ectothermic and endothermic animals, do organisms differ in the way they maintain salt balance ?



### Find out

How do freshwater fishes and marine fishes carry out osmoregulation ?

Whether conformers or regulators, most organisms can tolerate only narrow range of salt concentrations. Such organisms are called stenohaline organisms. (steno : narrow)

Those who are capable of handling wide changes in salinity are called euryhaline organisms ex. barnacles, clams etc.

Unicellular forms have contractile vacuoles which collect and discharge waste products outside the cell. Excretion in sponges takes place by diffusion of waste material in water which is discharged through osculum.

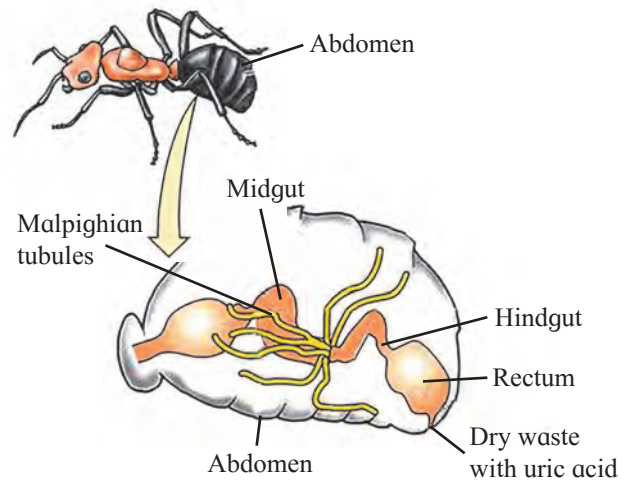
True organs of excretion are found in those animals that show bilateral symmetry. Most common type is simple or branching tube that opens to exterior through pores called nephridiopores.

**Two major types of nephridia :**

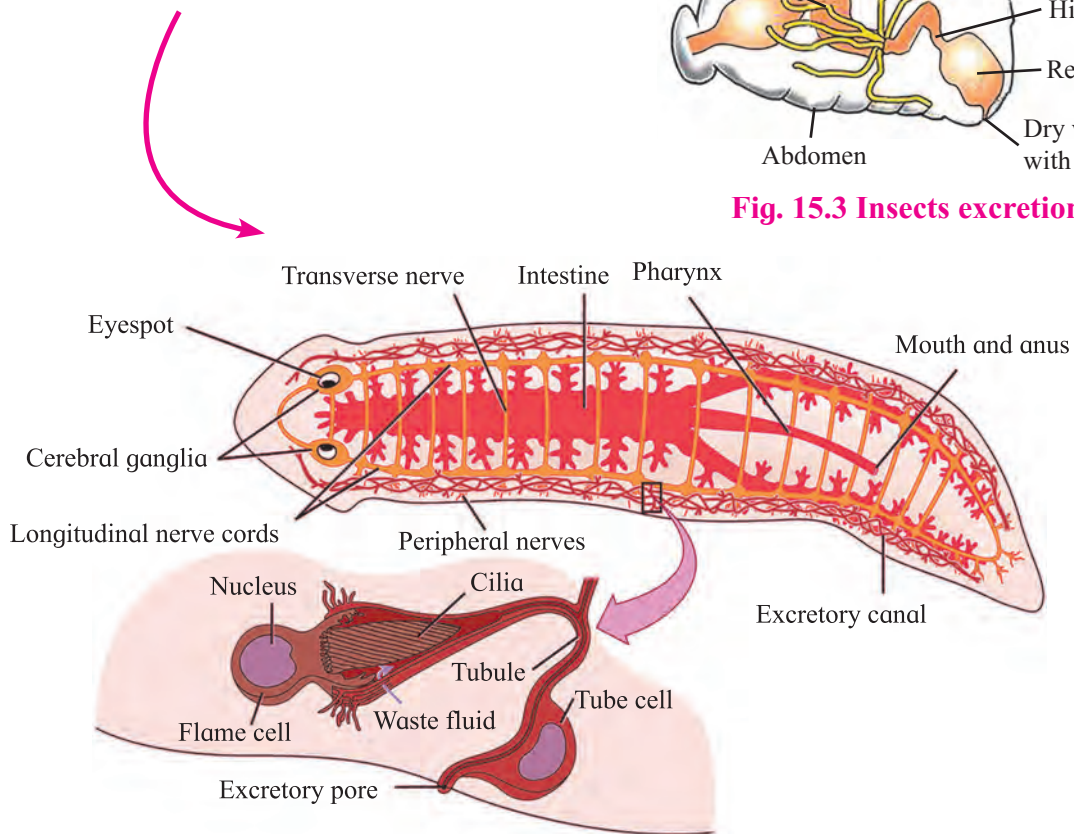
**Protonephridia :** These are network of dead end tubes called flame cells. These are found mostly in animals that lack true body cavity e.g. Platyhelminthes. Protonephridia are also found in rotifers, some annelids and *Amphioxus*.

**Metanephridia :** These are unbranched coiled tubes that connect to body cavity through funnel like structures called nephrostomes. Body fluid enters the nephridium through nephrostome and gets discharged through nephridiopore. eg. Earthworms.

In most of the insects, excretion takes place by set of blind ended tubules called malpighian tubules. Crustaceans have green glands as excretory organs. Members of phylum Echinodermata do not have any specialised excretory organs. Waste materials directly diffuse into water or are excreted through tube feet. Mammalian kidneys are a collection of functional units called nephrons, which are well designed to extract metabolic waste.



**Fig. 15.3 Insects excretion**



**Fig. 15.2 Excretory system in platyhelminthes**



### Make a table

1. The details of modes of excretion of nitrogenous wastes.
2. The excretory organs found in various animal phyla.



### Use your brain power

Creatinine is considered as index of Kidney function. Give reason.

## 15.2 Excretory system in human being :



### Observe and complete

Label the adjacent diagram and complete following paragraphs.

**Kidney :** A pair of ..... shaped kidneys are present on either side of ..... from 12<sup>th</sup> thoracic to 3<sup>rd</sup> Lumbar vertebra. Kidneys are present behind ..... Hence are called Retroperitoneal. Dimensions of each kidney are 10 x ..... x ..... cms. Average weight is ..... g in males and 135 g in ..... Outer surface is ..... and inner is concave. Notch on the inner concave surface is called ..... Renal artery enters and renal vein as well as ureter leave the kidney through hilus. Each kidney has almost 1 million functional units called .....

**Ureters :** A pair of ureters arise from ..... of each kidney. Each ureter is a long muscular tube 25-30 cm. in length. Ureters open into ..... by separate openings, which are not guarded by valves. They pass obliquely through the wall of urinary bladder. This helps in prevention of ..... of urine due to compression of ureters while bladder is filled.

**Urinary bladder :** It is a median ..... sac. A hollow muscular organ, the bladder is situated in pelvic cavity posterior to public symphysis. At the base of the ..... there is a small inverted triangular area called Trigone. At the apex of this triangle is opening of urethra. At the two points of the base of the triangle are openings of ureters. Urinary bladder is covered externally by peritoneum. Inner to peritoneum is muscular layer. It is formed by detrusor muscles which consist of three layers of smooth muscles. Longitudinal -circular-longitudinal respectively. Innermost layer is made up of transitional..... It helps bladder to stretch.

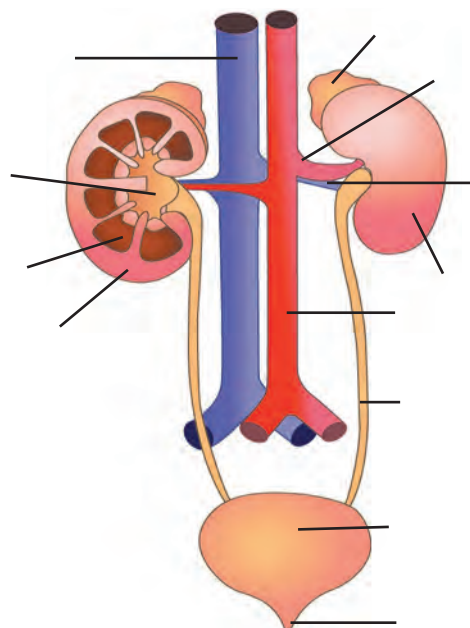


Fig. 15.4 Excretory system

**Urethra :** It is a ..... structure arising from urinary bladder and opening to the exterior of the body. There are ..... urethral sphincters between urinary bladder and urethra.

a. Internal sphincter : Made up of ..... muscles, involuntary in nature.

b. External sphincter : Made up of ..... muscles, voluntary in nature.

If this valve is not functioning properly during inflammation of bladder, it can lead to kidney infection.

Kidneys bring about separation and elimination of nitrogenous waste, excess water and toxic substances from the body. They maintain homeostasis by way of their role in osmoregulation and regulation of pH of body fluids. They produce calcitriol and renin. Erythropoietin secreted by kidneys is essential for production of RBCs. Ureters transport urine from renal pelvis to urinary bladder. Urinary bladder is a temporary storage organ for urine. It helps to expel urine (micturition). Urethra is a passage way for discharging urine from body. In males, it acts as urinogenital organ.



### Do you know ?

**Micturition :** Average capacity of urinary bladder is 700 ml. When urinary bladder is almost half filled, stretch receptors in urinary bladder transmit impulses to spinal cord. This initiates conscious desire to expel urine. Micturition reflex center of spinal cord transmit impulses to the wall of urinary bladder and internal urethral sphincter. Bladder muscles contract and muscles of internal urethral sphincter relax. Then external sphincter receives impulses from conscious centre of brain and relaxes. This leads to expellation/ elimination of urine from bladder.



### Internet my friend

Find out what is floating kidney?



### Can you recall?

Observe the figure carefully and label various regions of L.S. of kidney.



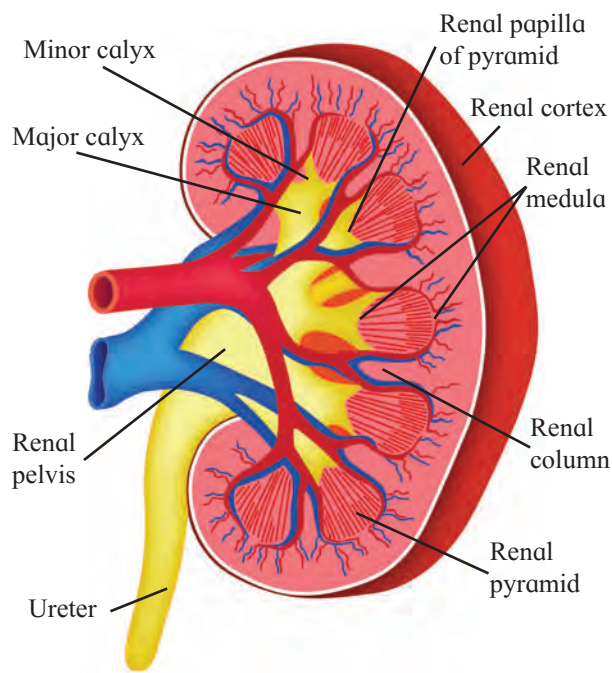
### Always Remember

Infants up to 2 years of age show lack of voluntary control over micturition. This is because neurons to the external sphincter muscles are not developed.

Each kidney is covered by 3 layers of tissue. Outermost Renal fascia is made up of thin layer of fibrous connective tissue. It anchors the kidney to abdominal wall as well as surrounding tissue.

Middle layer is a mass of fatty tissue called adipose capsule. Protects kidneys by shock absorption. Innermost layer, renal capsule is a smooth transparent fibrous membrane that is continuous with outer layer of ureters. It acts as a barrier against spread of infections in kidney. L.S. of kidney shows two distinct regions within capsule.

Histologically, kidney is divisible into two regions as renal cortex and renal medulla. Renal cortex is outer / peripheral, red coloured and granular region. Cortex contains Malpighian bodies, convoluted tubules and blood vessels. Medulla is inner region of kidney with pale red colour and striated appearance. Medulla mainly consists of Loops of Henle and collecting ducts. All these are arranged in conical manner to form renal pyramids. Cortex extends in medulla as columns of Bertini / renal columns between pyramids. Narrow tip of pyramid is called as renal papilla.



**Fig. 15.5 L. S. of Kidney**

There are several pyramids. Renal papilla open into minor calyx. Minor calyces merge together to form major calyces and major calyces unite together to form renal pelvis. Renal pelvis (renal sinus) is funnel-shaped area in the region of medulla of kidney. Renal pelvis continues as ureter which leaves kidney through hilus.



### Do you know ?

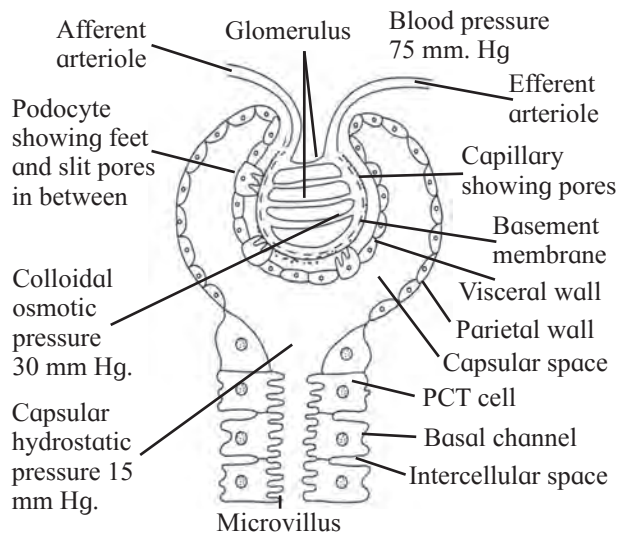
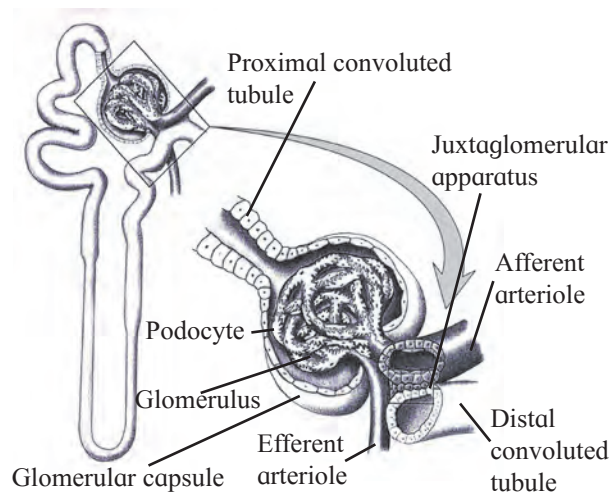
Nephrology is branch of biology that deals with structure, function and disorders of male and female urinary system.

**Nephron** : Nephrons are structural and functional units of kidney. Each nephron consists of about 4 - 6 cm long thin-walled tube- 'renal tubule' and a bunch of capillaries- 'glomerulus'. Wall of renal tubule is made up of single layer of epithelial cells. Its proximal end is wide, blind, cup-like, called as Bowman's capsule. Distal end is open. It is divisible into Bowman's capsule, neck, proximal convoluted tubule (PCT), Loop of Henle (LoH), distal convoluted tubule (DCT) and collecting tubule (CT).

Glomerulus is present in the cup-like cavity of Bowman's capsule and both are collectively known as renal corpuscle or Malpighian body.

Each Malpighian body is about 200 $\mu$ m in diameter and consists of a Bowman's capsule and glomerulus.

**Glomerulus** : Glomerulus is a bunch of fine blood capillaries lying in the cup of Bowman's capsule. A small terminal branch of renal artery called as afferent arteriole enters the cup cavity and undergoes extensive fine branching to form network of several capillaries. This bunch is called as glomerulus. Capillary wall is fenestrated. All capillaries reunite and form an efferent arteriole that leaves the cup cavity. Diameter of afferent is greater than efferent arteriole to create a high hydrostatic pressure in glomerulus. It is important for ultrafiltration.



**Fig. 15.6 Bowman's capsule and glomerulus**

**Bowman's capsule** : It is a cup-like structure having double wall. Both walls are composed of squamous epithelium. Outer wall is called as parietal and inner wall is called as visceral wall. There is a space called as capsular space / urinary space in between two walls. Visceral wall consists of special type of squamous cells called podocytes having a foot-like pedicel. These podocytes are in close contact with the walls of capillaries of glomerulus.

There are small slits called as filtration slits in between adjacent podocytes. Parietal wall is thin consisting of simple squamous epithelium. It continues into neck. The wall of neck is made up of ciliated epithelium. Lumen of neck is called urinary pole. Neck leads to proximal convoluted tubule.

**Proximal Convoluted Tubule :** This is highly coiled part of nephron. It is lined by cuboidal cells with brush border (microvilli) and surrounded by peritubular capillaries. It is place of selective reabsorption. Due to convolutions (coiling), filtrate flows slowly and remains in the PCT for longer duration. This ensures the reabsorption of maximum amount of useful molecules.

**Loop of Henle :** This is ‘U’ shaped tube consisting of descending and ascending limb. Descending limb is thin walled and permeable to water. It is lined with simple squamous epithelium. Ascending limb is thick walled and impermeable to water. It is lined with simple cuboidal epithelium. LoH is surrounded by capillaries called vasa recta. Its function is to operate counter current system - a mechanism for osmoregulation. Regulation of salt and water balance in body is called as osmoregulation. Ascending limb of Henle’s loop leads to DCT.

**Distal convoluted tubule:** This is another coiled part of nephron. Its wall consists of simple cuboidal epithelium.

DCT performs tubular secretion / augmentation/ active secretion in which, wastes are taken up from surrounding capillaries and secreted into passing urine.

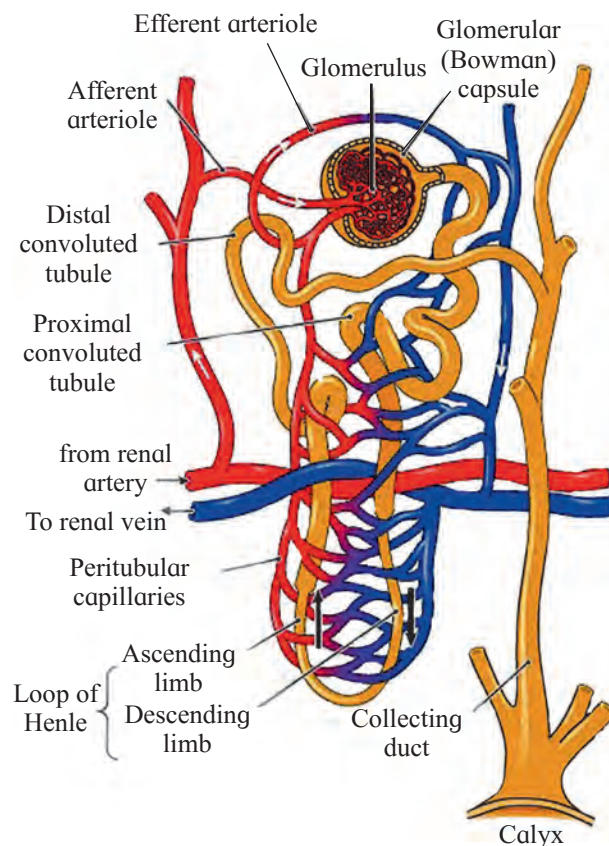
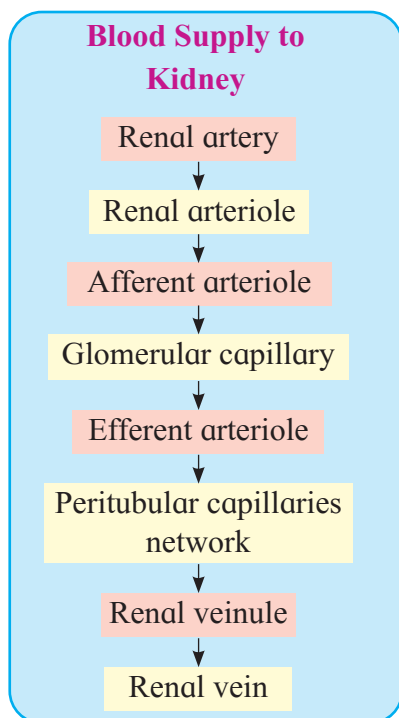
DCT helps in water reabsorption and regulation of pH of body fluids.

**Collecting tubule:** This is a short, straight part of DCT. Collecting tubule reabsorbs water and secretes protons. Collecting tubule opens to collecting duct.

There are two types of nephrons in human kidney. Cortical nephrons with shorter loop of Henle which extend very little in medulla. Most of the nephrons are cortical nephrons. Few nephrons have longer loop of Henle that runs deep into medulla. These are called Juxtamedullary nephrons.

A small branch of efferent arteriole forms peritubular capillary network around DCT, PCT and Henle’s loop of cortical nephrons also forms loop-shaped vasa recta around Henle’s loop of juxtamedullary nephrons.

Nephrons are responsible for elimination of waste and osmoregulation. Hence are richly supplied with blood. About one fourth of cardiac output is supplied to kidneys!



**Fig. 15.7 Nephron and peritubular capillaries network**

### Juxta Glomerular Apparatus :

Some smooth muscle cells of the wall of afferent arteriole are modified in such a way that their sarcoplasm is granular. These cells are called 'juxtaglomerular (JG) cells.

In each nephron, beginning part of DCT makes contact with the afferent arteriole of same nephron. Cells in the wall of DCT in this region are packed more densely than those in other region of DCT. This is called macula densa. Macula densa and the JG cells together form Juxta Glomerular Apparatus (JGA) that plays important role in blood pressure regulation within kidney.



#### Can you tell?

1. Why are kidneys called 'retroperitoneal'?
2. Why urinary tract infections are more common in females than males?
3. What is nephron? Which are its main parts? Why are they important?



#### Think about it

How much blood is supplied to kidney?

$$\therefore \text{EFP} = \text{Hydrostatic pressure in glomerulus} - (\text{Osmotic pressure of blood} + \text{filtrate hydrostatic pressure})$$

$$10 \text{ mmHg} = 55 - (30 + 15)$$

### 15.3 Urine formation :

Process of urine formation is completed in three successive steps as- Ultrafiltration / Glomerular filtration, Selective reabsorption, Tubular secretion / Augmentation.

#### a. Ultrafiltration / Glomerular filtration :

Diameter of afferent arteriole is greater than efferent arteriole. Diameter of capillaries is still smaller than both arterioles. Due to such difference in diameter, blood flows with greater pressure through glomerulus. This is called as glomerular hydrostatic pressure (GHP) and normally, it is about 55 mm Hg.

This pressure is opposed by osmotic pressure of blood (normally, about 30 mm Hg) and capsular pressure (normally, about 15 mm Hg). Hence net / effective filtration pressure (EFP) is 10 mm Hg.

Walls of capillaries are extremely thin. Under the effect of high pressure, walls become permeable to major components of blood (except blood cells and macromolecules like protein). Thus plasma except proteins oozes out through wall of capillaries. About 600 ml blood passes through each kidney per minute.

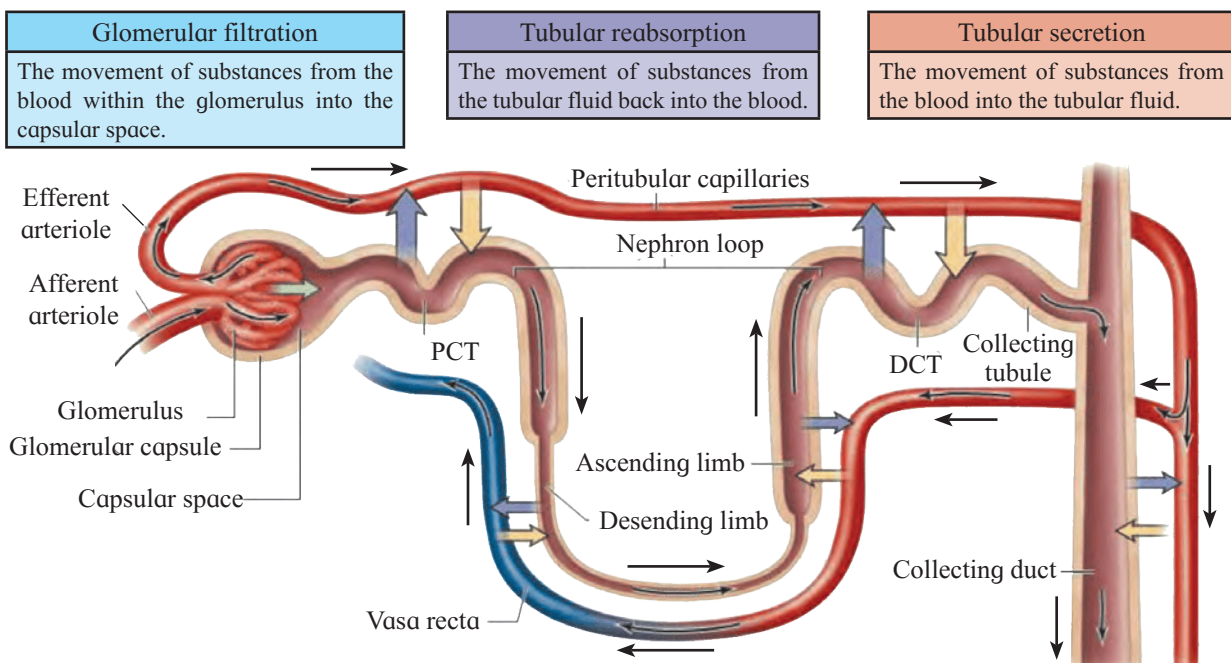
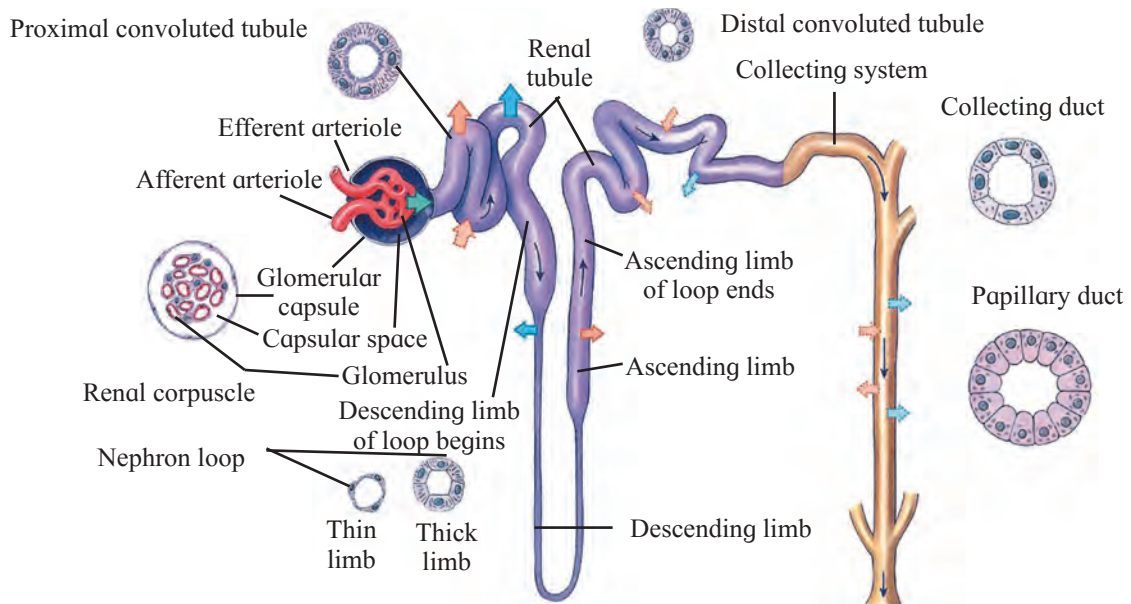


Fig. 17.8 Process of urine formation





**Fig. 15.9 Reabsorption**

The blood (plasma) flowing through kidney (glomeruli) is filtered as glomerular filtrate - at a rate of 125 ml / min. (180 L/d).

Glomerular filtrate / deproteinized plasma/primary urine is alkaline, contains urea, amino acids, glucose, pigments, and inorganic ions.

Glomerular filtrate passes through filtration slits into capsular space and then reaches the proximal convoluted tubule.

### b. Selective reabsorption :

PCT is place of reabsorption. It is highly coiled so that glomerular filtrate passes through it very slowly. Columnar cells of PCT are provided with microvilli due to which absorptive area increases enormously. This makes the process of reabsorption very effective.

These cells perform active (ATP mediated) and passive (simple diffusion) reabsorption.

Substances with considerable importance (high threshold) like - glucose, amino acids, Vit.C,  $\text{Ca}^{++}$ ,  $\text{K}^+$ ,  $\text{Na}^+$ ,  $\text{Cl}^-$  are absorbed actively, against concentration gradient. Low threshold substances like water, sulphates, nitrates, etc. are absorbed passively. In this way, about 99% of glomerular filtrate is reabsorbed in PCT and DCT.



### Do this

Check blood reports of patients and comment about possibility of glucosuria.

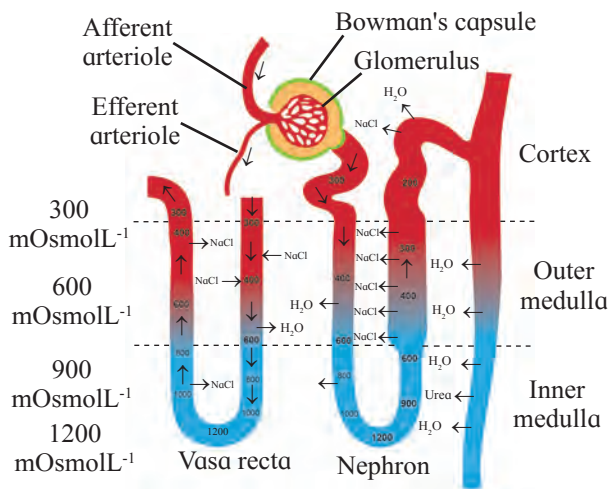
### c. Tubular secretion / Augmentation :

Finally filtrate reaches the distal convoluted tubule via loop of Henle. Peritubular capillaries surround DCT. Cells of distal convoluted tubule and collecting tubule actively absorb the wastes like creatinine and ions like  $\text{K}^+$ ,  $\text{H}^+$  from peritubular capillaries and secrete into lumen of DCT and CT, thereby augmenting the concentration of urine and changing its pH from alkaline to acidic.

Secretion of  $\text{H}^+$  ions in DCT and CT is an important homeostatic mechanism for pH regulation of blood. This process is called as tubular secretion or augmentation. Tubular secretion is only mode of excretion in marine bony fishes and desert amphibians.

### 15.4 Concentration of urine :

Under the conditions like low water intake or high water loss due to sweating, human can produce concentrated urine. It can be almost four times concentrated i.e. 1200 mOsm/L than the blood (300 mOsm/L). For this purpose, a mechanism called countercurrent mechanism is operated in human kidneys.



**Fig. 15.10 Concentration of urine**

Limbs of Henle's loop of juxtamedullary nephrons and vasa recta operate countercurrent mechanism as follows-

This mechanism involves the passage of fluid from descending to ascending limb of Henle's loop. Flow of tubular fluid is in opposite direction through both limbs; hence the name-counter (opposite) current (flow). In case of vasa recta, blood flows from ascending to descending parts of itself.

Wall of descending limb is thin and permeable to water where as that of ascending limb is thick and impermeable to water. In the region of descending limb, water diffuses from tubular fluid into tissue fluid due to which, tubular fluid becomes concentrated. Ascending limb of Henle's loop is thick walled and its cells can reabsorb Na<sup>+</sup> and Cl<sup>-</sup> from tubular fluid and release into tissue fluid.

Due to this, tissue fluid around descending limb becomes concentrated. This makes the more water to move out from descending limb into tissue fluid by osmosis. Thus, as tubular fluid passes down through descending limb, its osmolarity (concentration) increases gradually due to water loss and on the other hand, progressively decreases due to Na<sup>+</sup> & Cl<sup>-</sup> secretion as it flows up through ascending limb.

Besides, whenever water retention is necessary, pituitary secretes ADH.

ADH makes the cells in the wall of collecting ducts permeable to water. Due to this, water moves from tubular fluid into tissue fluid, making the urine concentrated.

Cells in the wall of deep medullar part of collecting ducts are permeable to urea. As concentrated urine flows through it, urea diffuses from urine into tissue fluid and from tissue fluid into the tubular fluid flowing through thin ascending limb of Henle's loop. This urea cannot pass out from tubular fluid while flowing through thick segment of ascending limb, DCT and cortical portion of collecting duct due to impermeability for it in these regions. However, while flowing through collecting duct, water reabsorption is operated under the influence of ADH. Due to this, urea concentration increases in tubular fluid and same urea again diffuses into tissue fluid in deep medullar region. Thus, same urea is transferred between segments of renal tubule and tissue fluid of inner medulla. This is called urea recycling; operated for more and more water reabsorption from tubular fluid and thereby excreting small volumes of concentrated urine.

Osmotic gradient is essential in the renal medulla for water reabsorption by countercurrent multiplier system. This osmotic gradient is maintained by vasa recta by operating countercurrent exchange system. Vasa recta also have descending and ascending limbs. Blood that enters the descending limb of the vasa recta has normal osmolarity of about 300 mOsm/L. As it flows down in the region of renal medulla where tissue fluid becomes increasingly concentrated, Na<sup>+</sup>, Cl<sup>-</sup> and urea molecules diffuse from tissue fluid into blood and water diffuse from blood into tissue fluid. Due to this, blood becomes more concentrated which now flows through ascending part of vasa recta. This part runs through such region of medulla where tissue fluid is less concentrated. Due to this, Na<sup>+</sup>, Cl<sup>-</sup> and urea molecules diffuse from blood to tissue fluid and water from tissue fluid to blood. This mechanism helps to maintain the osmotic gradient.

So as to reabsorb water to maximum capacity, loops of Henle are longer in desert mammals like camel. Due to this, camel excretes concentrated urine.



### Can you tell?

1. Explain the process of urine formation in details.
2. How does counter current mechanism help concentration of urine?



### Use your brain power

In which regions of nephron the filtrate will be isotonic to blood?



### Try this

Read the given urine report and prepare a note on composition of normal urine.

#### Report A

PERFECT PATHOLOGY Reg. No. :- \_\_\_\_\_

Dr. \_\_\_\_\_ Date :- \_\_\_\_\_

Patient name :- \_\_\_\_\_ Age :- \_\_\_\_\_ M/F

Reference :- Dr. \_\_\_\_\_

#### URINE ROUTINE

Quantity	
Colour	Pale yellow
Appearance	clear
Deposits	Absent
Reaction	Acidic
Specific gravity	1.02
Albumin	Absent
Sugar	Absent
Ketone bodies	Absent
Bile salts	Absent
Bile pigments	Absent
Occult blood	Negative
Casts	Absent



### Think and appreciate

How do kidneys bring about homeostasis? Is there any role of neuroendocrine system in it ?

## 15.5 Composition of Urine :

Normal urine is pale yellow coloured transparent liquid. This colour is due to pigment urochrome. Composition of urine depends upon food and fluid consumed by the individual.

Well yes; let us find out how : There are two ways. One by regulating water reabsorption through ADH and other by electrolyte reabsorption through RAAS.

Hypothalamus in midbrain has special receptors called osmoreceptors. They can detect change in osmolarity (measure of total number of dissolved particles per litre of solution) of blood.

If osmolarity of blood increases due to any reason such as after eating *namkeen* or due to sweating, in other words, due to water loss from the body, osmoreceptors trigger release of Antidiuretic hormone (ADH) from neurohypophysis. (posterior pituitary). ADH stimulates reabsorption of water from last part of DCT and entire collecting duct by increasing the permeability of cells. This leads to reduction in urine volume and decrease in osmolarity of blood. Once the osmolarity of blood comes to normal, activity of osmoreceptor cells decreases leading to decrease in ADH secretion. This is called negative feedback.



### Think

What would happen if ADH secretion decreases due to any reason ?

In case of haemorrhage or severe dehydration too, osmoreceptors stimulate ADH secretion. ADH is important in regulating water balance through kidneys.

In absence of ADH, diuresis (dilution of urine) takes place and person tends to excrete large amount of dilute urine. This condition called as diabetes insipidus.

Another regulatory mechanism is RAAS (Renin Angiotensin Aldosterone system) by Juxta Glomerular Apparatus (JGA).

Whenever blood supply (due to change in blood pressure or blood volume) to afferent arteriole decreases (e.g. low BP/dehydration), JGA cells release Renin. Renin converts angiotensinogen secreted by hepatocytes in liver to Angiotensin I. Angiotensin converting enzyme further modifies Angiotensin I to Angiotensin II, the active form of hormone.

### Angiotensin II has triple function

1. It constricts arterioles in kidney thereby reducing blood flow and increasing blood pressure.
2. Stimulates PCT cells to enhance reabsorption of  $\text{Na}^+$ ,  $\text{Cl}^-$  and water.
3. It stimulates adrenal cortex to release another hormone called aldosterone that stimulates DCT and collecting ducts to reabsorb more  $\text{Na}^+$  and water, thereby increasing blood volume and pressure.



### Use your brain power

Can we use this knowledge in treatment of high blood pressure? Why high BP medicines are many a times diuretics?

Would only ADH or only RAAS be sufficient for homeostasis?

Both ADH and RAAS are essential. Only ADH can lower blood- $\text{Na}^+$  concentration by way of water reabsorption in DCT and collecting duct, whereas RAAS stimulates  $\text{Na}^+$  reabsorption, thus maintains osmolarity of body fluid.

Action of ADH and RAAS leads to increase in blood volume and osmolarity. A large increase in blood volume and pressure stimulates atrial wall to produce atrial natriuretic peptide (ANP). ANP inhibits  $\text{Na}^+$  and  $\text{Cl}^-$  reabsorption from collecting ducts inhibits release of renin, reduces aldosterone and ADH release too. This leads to a condition called Natriuresis (increased excretion of  $\text{Na}^+$  in urine) and diuresis.



### Can you tell?

How do skin and lungs help in excretion ?

Kidneys participate in synthesis of calcitriol, the active form of Vitamin D which is needed for absorption of dietary calcium. Deficiency of calcitriol can lead to brittle bones.

### Something Interesting :

Vampire bat from south America is a nocturnal sanguivorous mammal. It feeds on blood of large birds and mammals. It has to fly long distances to locate suitable prey. Once found, it can even consume blood to an extent of more than half it's body mass. In such a case, the body of bat becomes too heavy to fly. To compensate for this, while the bat is feeding, it's kidneys excrete large amount of dilute urine (upto 24% of it's body mass). Now bat can fly back to the cave/tree where it can spend the day.

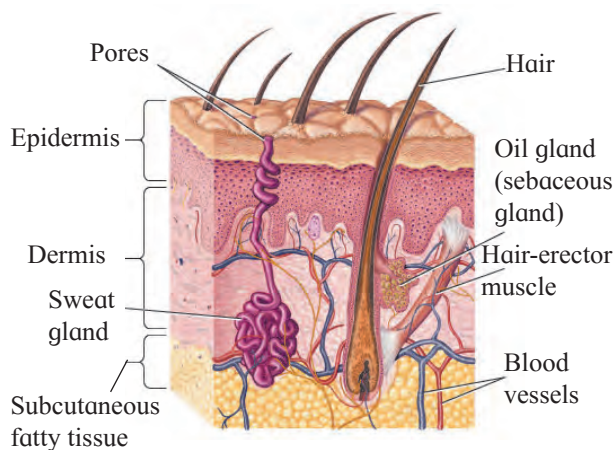
During day time, it cannot go to drink water. At the same time diet being high on proteins, large amount of nitrogenous waste is produced. Instead of diluting waste, kidneys resort to concentrating urine in order to conserve water. This capacity to rapidly change the osmolarity of urine is a classic example of adaptation.



## 15.6 Role of other organs in excretion :

### Skin :

Skin of many organisms is thin and permeable. It helps in diffusion of waste products like ammonia. Human skin is thick and impermeable. It shows presence of two types of glands namely, sweat glands and sebaceous glands. Sweat glands are distributed all over the skin. They are abundant in palm and facial regions.



**Fig. 15.11 L. S. of Skin**

These simple, unbranched, coiled, tubular, glands open on the surface of skin through an opening called sweat pore. Sweat is primarily produced for thermoregulation but it also excretes substances like water, NaCl, lactic acid and urea.

#### **Sebaceous glands :**

They are present at the neck of hair follicles. They secrete oily substance called sebum. It forms a lubricating layer on skin making it softer. It protects skin from infection and injury.

#### **Lungs :**

Lungs are the respiratory organs. They help in excretion of volatile substances like CO<sub>2</sub> and water vapour produced during cellular respiration. They also excrete volatile substances present in spices and other food stuff.



#### **Can you tell?**

1. What is the composition of sweat?
2. When does kidney produce renin? Where is it produced in kidney?
3. Explain role of lungs and skin in excretion.
4. Explain how electrolyte balance of blood plasma maintained.
5. Refer to blood report A and B what is the significance of values of albumin, blood cells, casts etc?

### **15.7 Disorders and diseases :**

Excessive albumin in urine (albuminuria) indicates injury to endothelial-capsular membrane as a result of increased blood pressure, injury or irritation of kidney cells by substances such as toxins or heavy metals. Presence of excessive quantities of ketone bodies in urine may be caused due to diabetes mellitus, starvation or too little carbohydrates in diet.

Presence of leucocytes in urine indicate possibility of infection of kidney or other urinary organs.

#### **1. Kidney stones :**

These are also called renal calculi - They may be formed in any portion of urinary tract-from kidney tubules to external opening.

Depending on composition they are classified into :

**Calcium stones :** Usually are calcium oxalate stones or calcium phosphate ones.

**Struvite stones :** These are formed in response to bacterial infection caused by urea splitting bacteria. These grow quickly and become quite large.

**Uric acid stones :** In people who don't drink enough water or consume high protein diet can suffer from this type of stones.

**Cystine stones :** It is a genetic disorder that causes kidney to excrete too much of certain amino acid.

**Symptoms :** Intermittent pain below rib cage in back and side ways. Hazy, brownish/reddish/pinkish urine. Frequent urge to pass urine. Pain during micturition.

**Diagnosis :** Uric acid content of blood, colour of urine, kidney X-ray, sonography of kidney are different diagnostic tests prescribed depending on symptoms.

#### **2. Uremia :**

Blood normally contains 0.01 to 0.03% urea; but if it rises above 0.05%, it is called uremia. It is harmful and may lead to kidney failure.

3. **Nephritis** : It is inflammation of kidneys characterised by proteinuria caused due to increased permeability of glomerular capsular membrane, permitting large amounts of proteins to escape from blood to urine. This leads to change in blood colloidal osmotic pressure, leading to movement of fluid from blood to interstitial spaces. It is reflected as edema.

4. **Renal Failure** : It is decrease or cessation of glomerular filtration, is classified into two types.

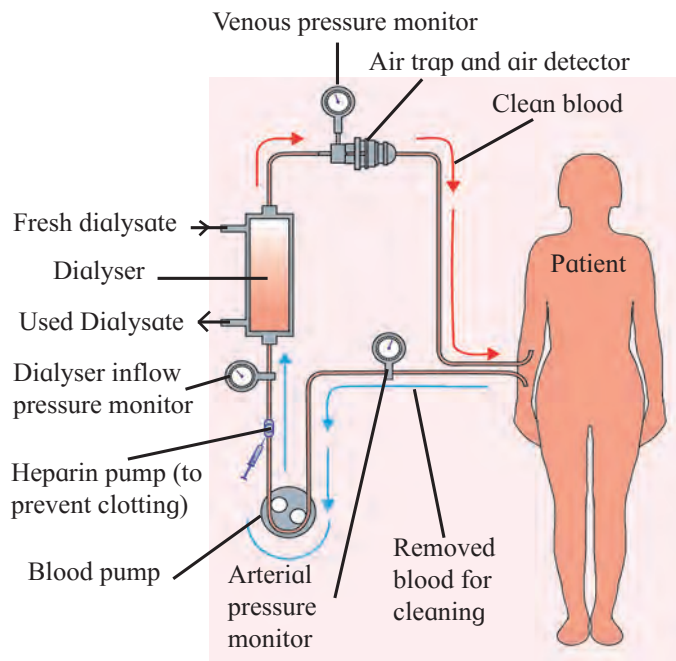
**a. Acute Renal failure (ARF)** : ARF is sudden worsening of renal function that most commonly happens after severe bleeding. There is decrease in urine output (oliguria-scanty urine) (less than 400 ml/day or less than 0.5 ml/kg/h in children). Other causes of ARF may include acute obstruction of both ureters or nephrotoxic drugs. ARF can be detected biochemically by elevated serum creatinine level.

**b. Chronic kidney disease (CKD)** : It is progressive and generally irreversible decline in glomerular filtration rate (GFR). It may be caused due to chronic glomerulonephritis. It can be detected by reduced kidney size and possibility of anaemia.

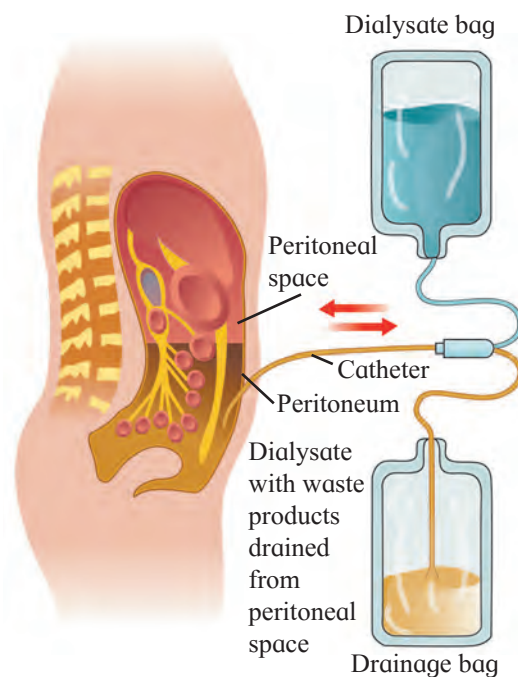
**Haemodialysis :**

When renal function falls below 5 to 7%, accumulation of harmful substances in blood begins. In such a condition, the person has to go for artificial means of filtration of blood. You have already studied about haemodialysis wherein dialysis machine is used to filter blood. In haemodialysis, blood is filtered outside the body using dialysis unit. In this procedure, patients' blood is removed; generally from radial artery. It is passed through a cellophane tube that acts as a semipermeable membrane. The tube is immersed in a fluid called dialysate. Dialysate is isosmotic to normal blood plasma. Hence only excess salts if present in plasma pass through the cellophane tube into the dialysate.

Waste substances being absent in the dialysate, move from blood into the dialyzing fluid. Filtered blood is returned to vein. In this process it is essential that anticoagulant like heparin is added to the blood while it passing through the tube and before resending it into the circulation, adequate amount of anti-heparin is mixed. The blood has to move slowly through the tube and hence the process is slow.



**Fig. 15.12 Haemodialysis**



**Fig. 15.13 Peritoneal dialysis**



### Always Remember

Dialysis is regarded as a 'holding measure' until a renal transplant can be performed or sometimes as the only supportive measure in those for whom a transplant would be inappropriate.

### Peritoneal dialysis :

In this method, the dialyzing fluid is introduced in abdominal cavity or peritoneal cavity. The peritoneal membrane acts as semipermeable dialyzing membrane.

Toxic wastes and extra solutes pass into the fluid. This fluid is drained out after prescribed period of time. Peritoneal dialysis can be repeated as per the need of the patient. It can be carried out at home at work or while travelling. But it is not as efficient as haemodialysis.

Kidneys are associated with secretion of erythropoietin, renin and calcitriol which is not possible using dialysis machine.

### 5. Kidney transplant :

It is organ transplant of a healthy kidney into a patient with end stage renal disease. Kidney transplantation is classified as cadaveric (deceased donor) or living donor kidney transplant. Living donor kidney transplant are further classified as genetically related (living-related) or non-related (living non-related) transplants.



### Use your brain power

If a person is undergoing kidney transplant, immunosuppressants are administered. Justify.



### Internet my friend

1. Treatments other than surgical removal of kidney stone like Lithotripsy. (Breaking down of kidney stones using shock waves).
2. Dietary restrictions suggested for kidney patients.



## Exercise

### 1. Choose correct option

- A. Which one of the following organisms would spend maximum energy in production of nitrogenous waste?  
a. Polar bear    b. Flamingo  
c. Frog            d. Shark
- B. In human beings, uric acid is formed due to metabolism of \_\_\_\_\_.  
a. amino acids            b. fatty acids  
c. creatinine              d. nucleic acids
- C. Visceral layer : Podocytes :: PCT : \_\_\_\_\_  
a. Ciliated cells  
b. Squamous cells  
c. Columnar cells  
d. Cells with brush border
- D. Deproteinised plasma is found in \_\_\_\_\_.  
a. Bowman's capsule  
b. Descending limb  
c. Glomerular capillaries  
d. Ascending limb
- E. Specific gravity of urine would \_\_\_\_\_ if level of ADH increases.  
a. remain unaffected    b. increases  
c. decreases              d. stabilise
- F. What is micturition?  
a. Urination    b. Urine formation  
c. Uremia        c. Urolithiasis
- G. Which one of the following organisms excrete waste through nephridia?  
a. Cockroach    b. Earthworm  
c. Crab            d. Liver Fluke
- H. Person suffering from kidney stone is advised not to have tomatoes as it has \_\_\_\_\_.  
a. seeds                      b. lycopene  
c. oxalic acid                d. sour taste
- I. Tubular secretion does not take place in \_\_\_\_\_.  
a. DCT                        b. PCT  
d. collecting duct          d. Henle's loop
- J. The minor calyx \_\_\_\_\_.  
a. collects urine  
b. connects pelvis to ureter  
c. is present in the cortex  
d. receives column of Bertini
- K. Which one of the followings is not a part of human kidney?  
a. Malpighian body  
b. Malpighian tubule  
c. Glomerulus  
d. Loop of Henle
- L. The yellow colour of the urine is due to presence of \_\_\_\_\_.  
a. uric acid                  b. cholesterol  
c. urochrome                d. urea
- M. Hypotonic filtrate is formed in \_\_\_\_\_.  
a. PCT    b. DCT    c. LoH    d. CT
- N. In reptiles, uric acid is stored in \_\_\_\_\_.  
a. cloaca            b. fat bodies  
c. liver              d. anus
- O. The part of nephron which absorbs glucose and amino acid is \_\_\_\_\_.  
a. collecting tubule  
b. proximal tubule  
c. Henle's loop  
d. DCT
- P. Bowman's capsule is located in kidney in the \_\_\_\_\_.  
a. cortex            b. medulla  
c. pelvis            d. pyramids
- Q. The snakes living in desert are mainly \_\_\_\_\_.  
a. aminotelic                b. ureotelic  
c. ammonotelic              d. uricotelic



- R. Urea is a product of breakdown of \_\_\_\_\_  
 a. fatty acids    b. amino acids  
 c. glucose        d. fats
- S. Volume of the urine is regulated by \_\_\_\_\_  
 a. aldosterone    b. ADH  
 c. both a and b    d. none

**2. Answer the following questions**

- A. Doctors say Mr. Shaikh is suffering from urolithiasis. How it could be explained in simple words?
- B. Anitaji needs to micturate several times and feels very thirsty. This is an indication of change in permeability of certain part of nephron. Which is this part?
- C. Effective filtration pressure was calculated to be 20 mm Hg; where glomerular hydrostatic pressure was 70 mm of Hg. Which other pressure is affecting the filtration process? How much is it?

- D. Name any one guanotelic organism.
- E. Why are kidneys called 'retroperitoneal'?
- F. State role of liver in urea production.
- G. Why do we get bad breath after eating garlic or raw onion?

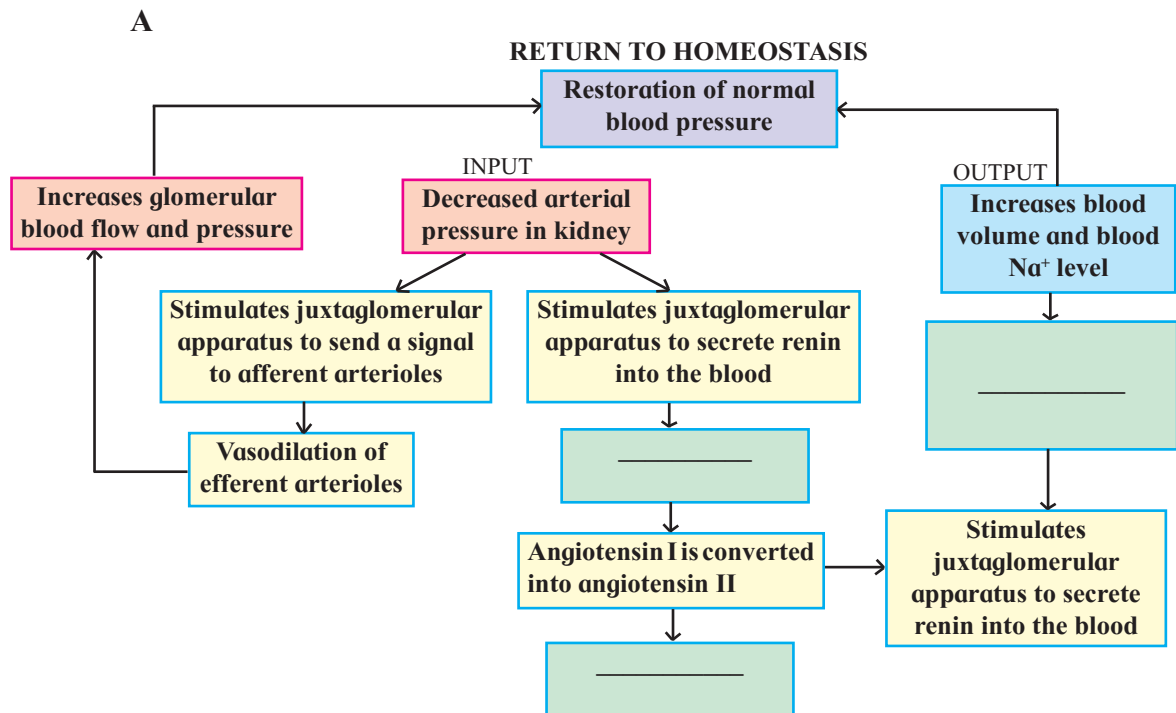
**3. Answer the following questions**

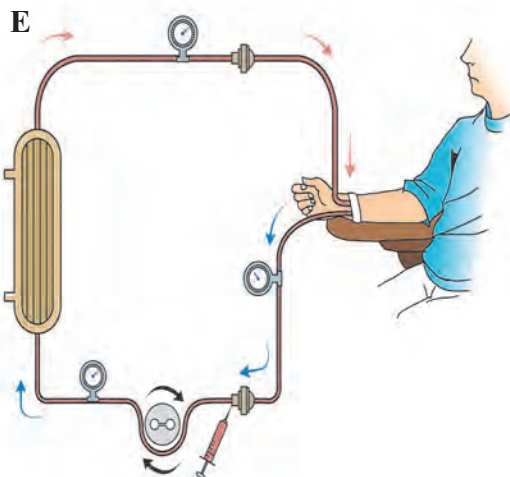
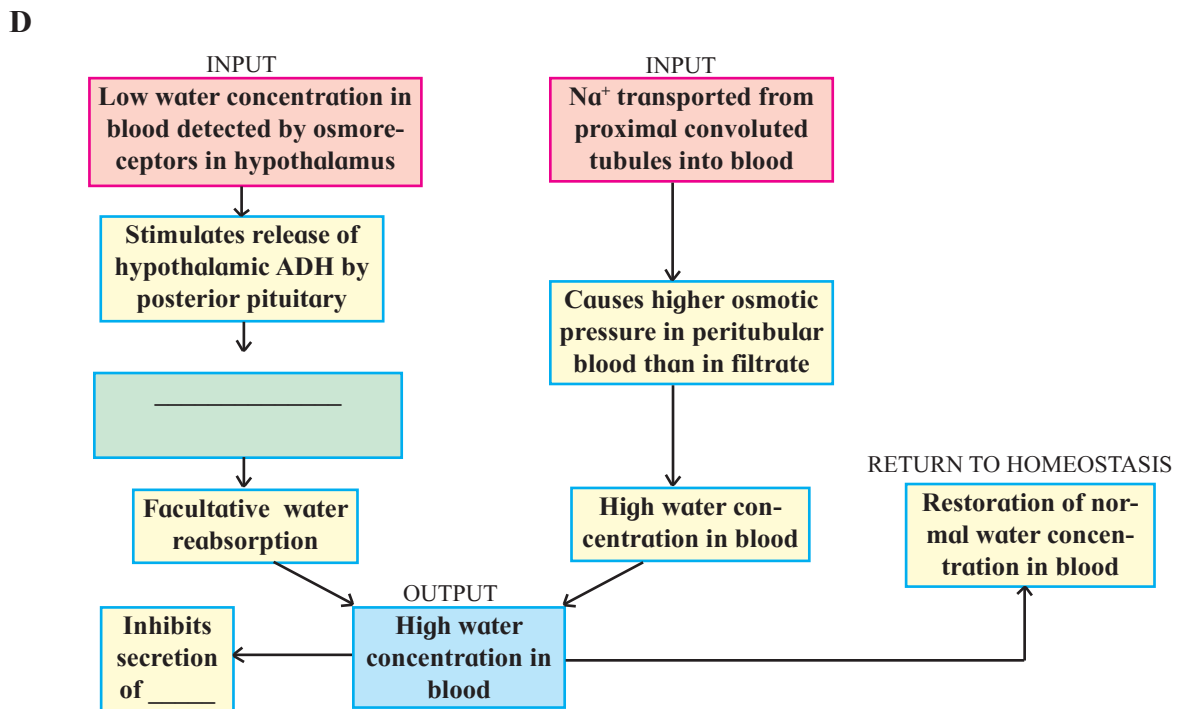
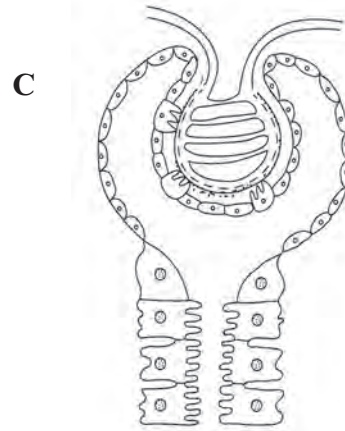
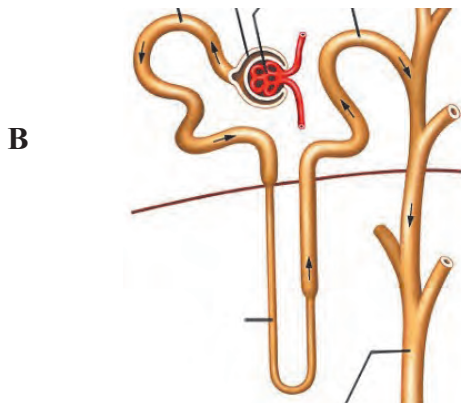
- A. John has two options as treatment for his renal problem : Dialysis or kidney transplants. Which option should he choose? Why?
- B. Amphibian tadpole can afford to be ammonotelic. Justify.
- C. Birds are uricotelic in nature. Give reason.

**4. Write the explanation in your word**

- A. Nitya has been admitted to hospital after heavy blood loss. Till proper treatment could be given; how did Nitya's body must have tackled the situation?

**5. Complete the diagram / chart with correct labels / information. Write the conceptual details regarding it**





**6. Prove that mammalian urine contains urea.**

**Practical / Project :**

Visit to a nearby hospital or pathological laboratory and collect detailed information about different blood and urine tests.

## 16. Skeleton and Movements



### Can you recall?

1. Which are different types of muscular tissues ?
2. Name the type of muscles which bring about running and speaking.
3. Name the muscles which do not contract as per of our will.
4. Which types of muscles show rhythmic contractions?
5. Which type of muscle is present in the diaphragm of the respiratory system ?
6. Name the part of human skeleton situated along the vertical axis.

Organism exhibit varieties of the movements. Movements vary from streaming of protoplasm to peristalsis to walking or running etc. A movement may or may not end up into locomotion or displacement of organism.

### 16.1 Movements and locomotion :

**Movements :** Movements may be internal or external. Which of the above mentioned the movements are internal? Which are external? Can you add few more examples! Movements may be voluntary or involuntary. Three type of muscles bring about these movements in human beings.

- a. Smooth muscles bring about involuntary movements like peristaltic movements in the alimentary canal, constriction and dilation of blood vessels, etc.
- b. Contraction and relaxation of the heart is controlled by cardiac muscles.
- c. Voluntary movements of limbs, head, trunk, eyes, etc. are controlled by striated muscles.

**Locomotion :** The change in locus of whole body of living organism from one place to another place is called locomotion. Locomotion is for search of food, shelter, mate, breeding ground and escape from enemy. There are four basic types of locomotory movements found throughout the animal kingdom.

1. **Amoeboid movement :** performed by pseudopodia e.g. leucocytes.
2. **Ciliary movement :** performed by cilia e.g. ciliated epithelium. In *Paramecium*, cilia help in passage of food through cytopharynx.

3. **Whorling movement :** performed by flagella e.g. Sperms.



### Always Remember

There are about 640 muscles in human body. Out of these 634 are paired and 6 muscles are unpaired.



### Think about it

1. Why do we shiver during winter ?
2. Why do muscles show spasm after rigourous contraction?
3. Did you ever feel tickling in muscles?

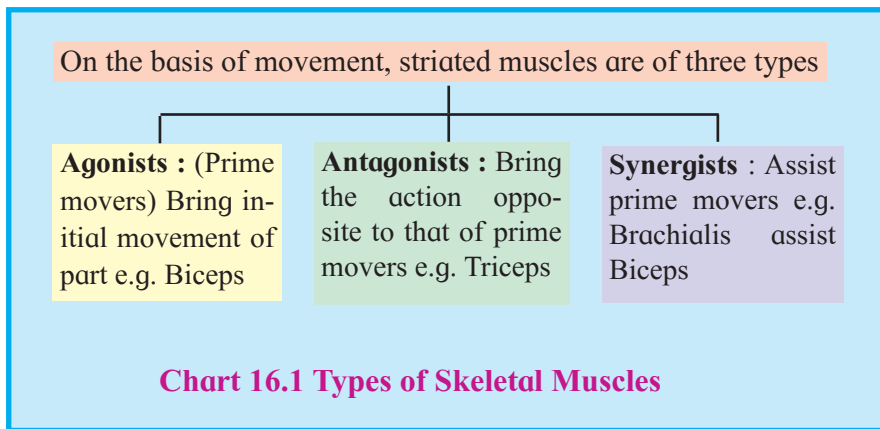
4. **Muscular movement :** Performed by muscles, with the help of bones and joints.

**Remember :** All locomotions are movements but all movements are not locomotion.

Skeletal muscles are attached to the bones by tendons and help in the movement of the parts of skeleton. Tendons are inelastic thick band of collagen fibers. Movement and locomotion is the combined action of bones, joints and skeletal muscles.

### 16.2 Location and structure of skeletal muscles :

Major part of the muscle which moves a bone usually do not lie on the same bone but is located on the bone atop. e.g. Biceps and triceps that move forearm are located in the upper arm. At any joint, two types of bones are present i.e. stationary and movable.



The end of muscle attached to stationary bone is called origin while the opposite end attached to movable bone is called insertion. The middle thick part of muscle is called belly. All the fibres in a muscle do not extend from end to end and there is a maximum number in the middle. Thus, large muscles are most often fusiform in shape.

### 16.3 Working of Skeletal Muscles :

Generally muscles work in pairs and produce opposite action e.g. Biceps (flexors) bring flexion (folding) and triceps (extensors) bring extension of elbow joint. The muscles which bring opposite action are called antagonistic. If one member of a pair is capable of bending the joint by pulling of bones, the other member is capable of straightening the same joint also by pulling. e.g. Triceps and Biceps of upper arm are antagonistic to each other.

In antagonistic pair of muscles, one member is much stronger than the other. e.g. The biceps is stronger than the triceps.

The fundamental characteristic of muscle is contraction. Therefore, muscle can only pull and not push the bone.



#### Can you recall?

Comment on contraction of skeletal muscles (Hint : Refer chapter on Animal Tissues)

### Some important antagonistic muscles

1. **Flexor and Extensor:** Flexor muscle on contraction results in bending or flexion of a joint e.g. Biceps. Extensor on contraction results in straightening or extension of a joint e.g. Triceps.
2. **Abductor and Adductor :** Abductor muscle moves body part away from the body axis e.g. Deltoid muscle of shoulder moves the arm away from the body. Adductor moves body part towards the body axis e.g. Latissimus dorsi of shoulder moves the arm near to the body.
3. **Pronator and Supinator :** Pronator turns the palm downward. Supinator turns the palm upward.
4. **Levator and Depressor :** Levator raises a body part. Depressor lowers the body part
5. **Protractor and Retractor :** Protractor move forward. Retractor move backward.
6. **Sphincters :** Circular muscles present in inner wall of anus, stomach, etc. for closure and opening.



#### Can you tell?

1. Why are movement and locomotion necessary among animals?
2. Differentiate between :
  - a. Flexor and extensor muscles
  - b. Pronator and Supinator.
3. What are antagonistic muscles? Explain with example.

You are aware that both flexion and extension take place by contraction of skeletal muscles. Do you know, how do these muscles contract and bring about movement and locomotion? Striated muscles are specifically designed to bring about vigorous contractions.

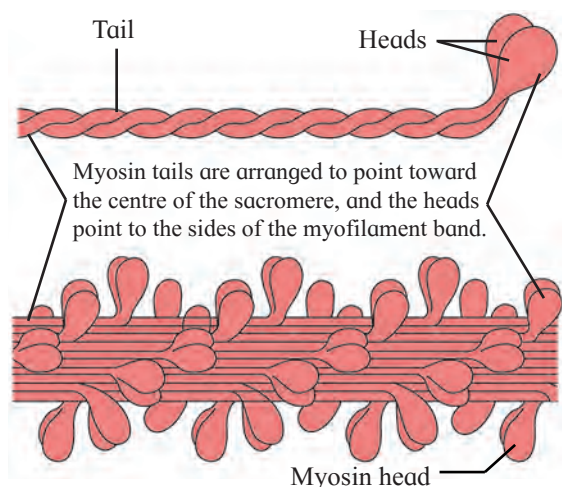
Refer to ultra-microscopic structure of skeletal muscle you have studied in animal tissues. The contractile unit of muscles is called sarcomere which contains contractile proteins actin and myosin.

### Structure of myosin and actin filaments :

#### Myosin filament :

Each myosin filament is a polymerized protein. Many monomeric proteins called meromyosins constitute one thick filament. Myosin molecule consists of two heavy chains (heavy meromyosin/HMM) coiled around each other forming double helix. One end of each of these chains is projected outwardly. It is known as cross bridge. This end is folded into a globular protein mass called myosin head.

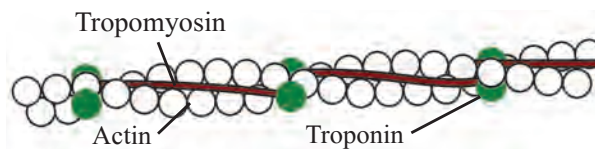
Two light chains are associated with each head (Total 4 light chains/light meromyosin/LMM). Myosin head has a special ATPase activity. It can split ATP to produce energy. Myosin contributes 55% of muscle proteins.



**Fig. 16.2 Myosin filament**

#### Actin filament :

It is also a complex type of contractile protein. It consists of three different components.



**Fig. 16.3 Actin filament**

- i. **F actin** : It forms the backbone of actin filament. It is double stranded protein. Each strand is composed of polymerized G actin molecules. One ADP molecule is attached to each G actin molecule.
- ii. **Tropomyosin** : The actin filament contains two additional protein strands that are polymers of tropomyosin molecules. Each strand is loosely attached to an F actin. In the resting stage, tropomyosin physically covers the active binding sites for myosin of the actin strand.
- iii. **Troponin** : It is a complex of three globular proteins, which are attached approximately  $2/3^{\text{rd}}$  distance along each tropomyosin molecule. It has affinity for actin, tropomyosin and calcium ions. The troponin complex is believed to attach the tropomyosin to the actin. The strong affinity of troponin for calcium ions is believed to initiate the contraction process.

### 16.4 Mechanism of muscle contraction :

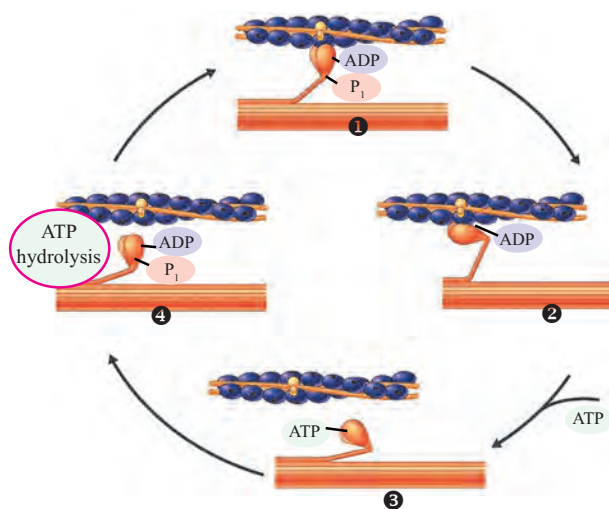
Sliding filament theory was put forth by H.E. Huxley and A.F. Huxley. It is also called walk along theory or Ratchet theory.

According to this theory, interaction between actin and myosin is the basic cause of muscular contraction. Actin filaments are interdigitated with myosin filaments. (like the crossing of fingers of two hands)

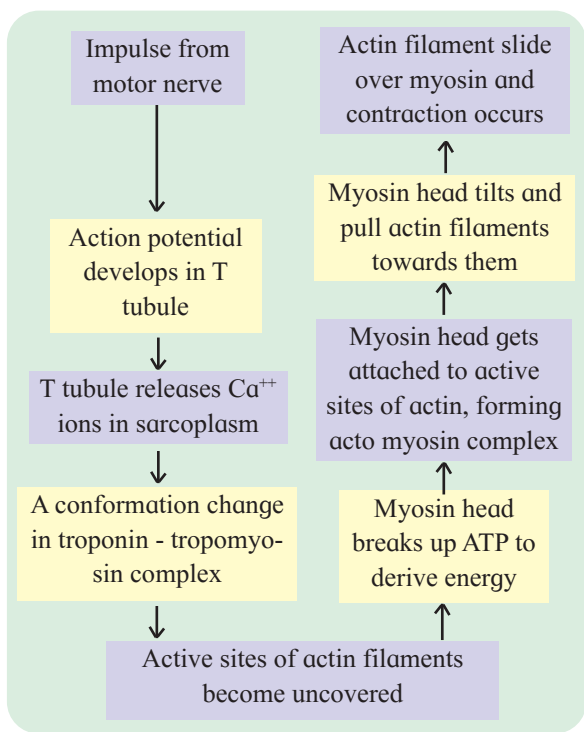
The head of the myosin is joined to the actin backbone by a cross bridge forming a hinge joint. From this joint, head can not tilt in forward and backward directions. This movement is an active process which requires use of ATP.

Myosin head contains ATPase activity. It can derive energy by the breakdown of ATP molecule. This energy can be used for the movement of myosin heads.

During contraction process, the myosin heads gets attached to the active site of actin filaments and pull them inwardly, so that actin filaments slide over the myosin filaments. This results in the contraction of muscle fibre.



**Fig. 16.4 Cyclic events in muscle Contraction**



**Chart 16.5 Mechanism of Muscle Contraction**

### 16.5 Physiology of muscle relaxation :

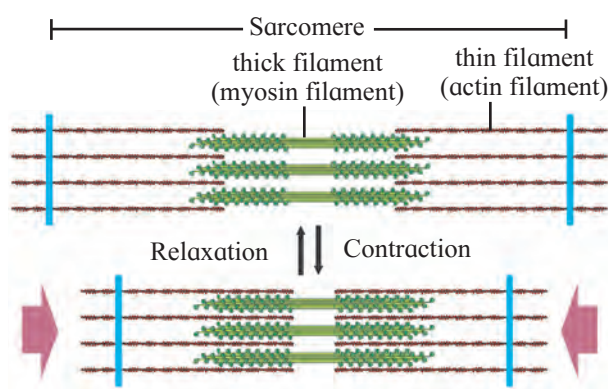
When the muscle is relaxed, the active sites remain covered with tropomyosin and troponin complex. Due to this, myosin cannot interact with active site of actin and therefore contraction cannot occur. When an action potential (impulse) comes to muscle through motor end plate, it spreads throughout the sarcolemma of the myofibril. The transverse tubules of sarcoplasmic reticulum releases large number of calcium ions into sarcoplasm.

These calcium ions interact with troponin molecules. This interaction inactivates troponin-tropomyosin complex. This leads to change in the structure of tropomyosin.

As a result, it gets detached from the active site of actin (F actin) filament. Thus active site becomes uncovered. Now head of the myosin cleaves the ATP and derives energy.

Using this energy, myosin gets attached to the uncovered active site of actin and results in the formation of actomyosin complex.

The myosin heads are now tilted backwards and pull the attached actin filament inwardly. This results in contraction of the muscle fibres.



**Fig. 16.6 Relaxation and contraction of muscle**



#### Internet my friend

Collect information about 'T' tubules of sarcoplasmic reticulum.

## 16.6 Relaxation of muscle fibres :

During relaxation all the events occur in reverse direction. When stimulation is terminated, actomyosin complex is broken down and myosin head gets detached from actin filaments. This process involves use of ATP. At the same time calcium ions return back. This is also an active process that uses energy. Due to disappearance of calcium ions, troponin – tropomyosin complex is restored again. This complex covers the active sites of actin filament. Due to this the interaction between actin and myosin ceases to occur and the actin filaments return back to their original position. This results in muscular relaxation. Like contraction, relaxation is also an active process.



### Always Remember

Oxygen debt is used in oxidizing the accumulated lactic acid aerobically and in restoring the depleted creatine phosphate and ATP.

**Rigor Mortis :** Usually, some hours after the death of an individual, its muscles are stiffened. This muscular stiffening, after death is rigor mortis. It helps in fixation of hours of death after a murder. After death, the fresh supply of ATP to muscles becomes impossible. Therefore once the local store of ATP is finished, the detachment of myosin from actin cannot take place. This results in permanent state of contraction of the muscle.



### Can you tell?

1. Why are muscle rich in creatine phosphate?
2. What do you understand by muscle twitch?
3. Explain mechanism of muscle contraction and relaxation.
4. Explain the chemical changes taking place in muscle contraction.

## 16.7 Properties of Muscles on Electrical Stimulation:

- A. Single muscle twitch :** A muscle contraction initiated by a single brief-stimulation is called a single muscle twitch. It occurs in 3 stages : a latent period of no contraction, a contraction period and a relaxation period.
- B. Summation :** If the muscle is stimulated before the end of the twitch, it generates greater tension i.e., summation or addition of effect takes place. Repeated stimuli will produce increasing strength of contraction (stair case phenomenon).
- C. Tetanus :** If stimulation is very rapid and frequent the muscle does not have time to relax. It remains in a state of contraction called tetanus.
- D. Refractory period :** Immediately after one stimulus, the muscle fibre cannot respond to another stimulus. This resting or refractory period is about 0.02 seconds.
- E. Threshold stimulus :** For a muscle fibre to contract, a certain minimum strength or intensity of stimulus is required. This is called threshold stimulus.
- F. All or none principle :** A stimulus below threshold will not result in contraction. A threshold stimulus will result in contraction. This contraction leads to maximum force. Higher stimulus will not increase force of contraction i.e. a muscle fibre contracts either fully or not at all. This is 'all or none' principle. All types of muscle fibres and nerve fibres obey this law.
- G. Oxygen debt :** During strenuous exercise, muscle's oxygen supply rapidly becomes insufficient to maintain oxidative phosphorylation of respiratory substrate. At this stage, muscles contract anaerobically and accumulate lactic acid produced by anaerobic glycolysis. Lactic acid produces less ATP and is toxic. It causes tiredness, pain and muscle cramps. During recovery, oxygen consumption of the muscle far exceeds than that in the resting state. This extra oxygen consumed during recovery is called oxygen debt of the muscle.



### Do you remember?

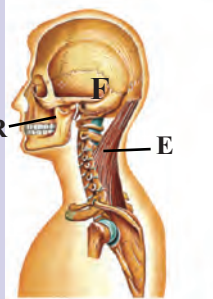
1. What are the components of our skeletal system ?
2. What type of bones are present in our body?
3. How do bones help us in various ways ?



### Use your brain power

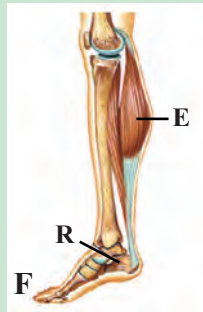
Can you compare bone, muscle and joint which help in locomotion with any of simple machines you have studied earlier ?

We can compare this unit with lever. Where joint acts as fulcrum, respective muscle generates the force required to move the bone associated with joint.



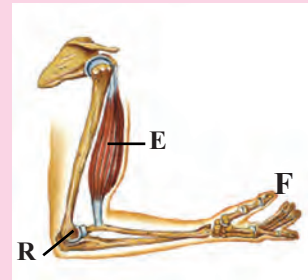
**Class I lever :** The joint between the first vertebra and occipital condyle of skull is an example of first class lever. The force is directed towards the joints (fulcrum); contraction of back muscle provides force while the part of head that is raised acts as resistance.

Resistance (R)      Fulcrum (F)      Effort (E)



**Class II lever :** Human body raised on toes is an example of second class lever. Toe acts as fulcrum, contracting calf muscles provides the force while raised body acts as resistance.

F      R      E



**Class III lever :** Flexion of forearm at elbow exhibit lever of class III. Elbow joint acts as fulcrum and Radius and ulna provides resistance. Contracting biceps muscle provides force for the movement.

R      E      F

## 16.8 Skeletal System :

Multicellular animals need support to maintain body structure. Various groups of organisms show various supportive structures; either inside or outside the body or both inside as well as outside. You have studied that these skeletal structures are called exoskeleton. When present on outer surface of the body and endoskeleton when they are present inside the body.

Bones and cartilage form major endoskeletal components. Exoskeletal components change from lower to higher groups of animals. These include chitinous structures, nails, horns, hooves, scales, hair, etc; you may add to the list.

Do any of these exoskeletal structures help in movement and locomotion? How do scales and plates of a snake help in movement and locomotion? Are scales of a fish and that of a snake similar? Find out more information about exoskeletal structures and their role in movement and locomotion.

Can you imagine life without skeletal system? Our skeletal system is made up of cartilage and bone; which together form the framework of the body. Cartilage is slightly pliable while bones have hard matrix.

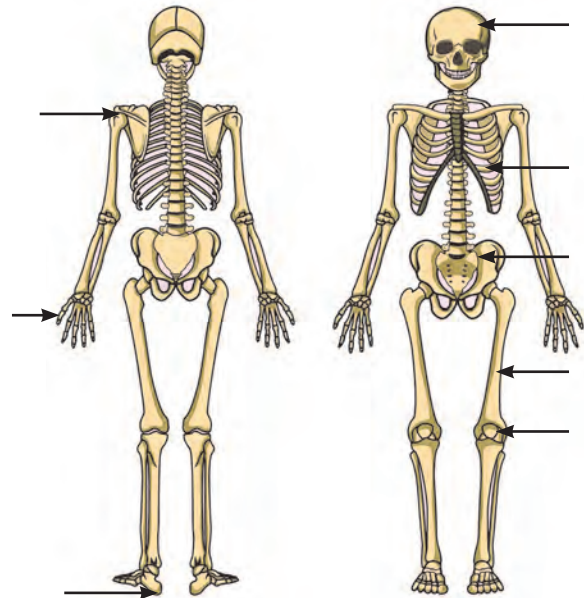


Bones form the framework of our body and thus provide shape which give us our identity. They protect delicate organs thus help in smooth functioning of body. Joints between bones help in movement and locomotion. Bones provide firm surface for attachment of muscles. They are reservoirs of calcium and one important site for haemopoiesis.

Endoskeleton of an adult human consists of 206 bones which can be grouped into two principle divisions; axial and appendicular skeleton.

Bones of axial skeleton lie along the longitudinal axis of human body. Bones of appendicular skeleton include bones of fore limb, hind limb and girdles. Girdles are the bones that connect the limbs to the axial skeleton.

**Identify and label**  
Identify the different bones.



**Fig. 16.7 Human Skeleton**



**Use your brain power**

Why are long bones slightly bent and not straight ?

**16.9 Group of skeleton :**

**A. Axial Skeleton :**

**Skull :**

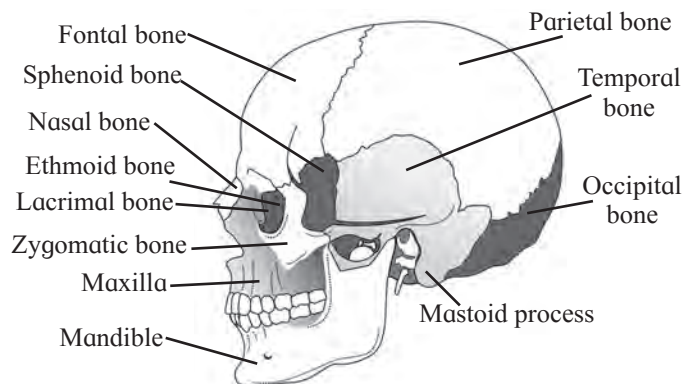
Made up of 22 bones, skull is located at superior end of vertebral column. It consists of two main sets of bones, cranium or brain box and facial bones. Bones are joined by fixed or immovable joints except for lower jaw.

**Cranium :**

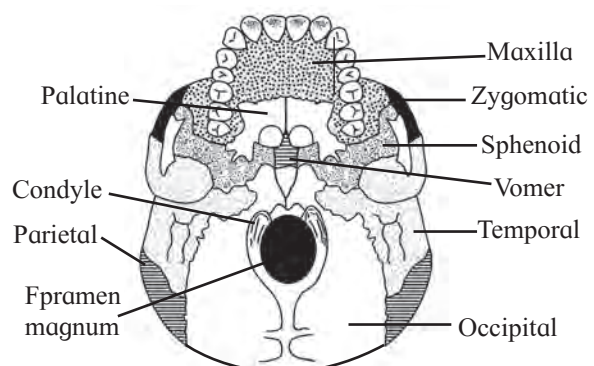
It is made up of four median and two paired bones.

**Frontal bone :** Median bone (Unpaired) forms forehead, roof of orbit (eye socket) and most of the anterior part of cranium. It is connected to two parietals, sphenoid and ethmoid bone.

**Parietal bones :** Paired bones, form roof of the cranium and greater portion of sides of the cranium.



**Fig. 16.8 Lateral view of skull**



**Fig. 16.9 Ventral view of skull**

**Temporal bones :** Paired bones situated laterally just above the ear on either side. Each temporal bone gives out zygomatic process that joins zygomatic bone to form zygomatic arch. Just at the base of zygomatic process is mandibular fossa, a depression for mandibles (lower jaw bone) that forms only movable joint of skull. This bone harbours ear canal that directs sound waves into the ear.

Processes of temporal bones provide points for attachment for various muscles of neck and tongue.

**Occipital bone :** Present at the back of the head, this single bone forms posterior part and most of the base of cranium. Inferior part of this bone shows 'Foramen magnum' the opening through which medulla oblongata connects with spinal cord. On either side of foramen magnum are two prominent protuberances called 'Occipital condyles'. These fit into the corresponding depressions present in 1<sup>st</sup> vertebra.

**Sphenoid bone :** Median bone present at the base of the skull that articulates with all other cranial bones and holds them together. This butterfly shaped bone has a saddle shaped region called sella turcica. In this hypophyseal fossa, the pituitary gland is lodged.

**Refer :** Read about sella turcica in chapter hormonal co-ordination.

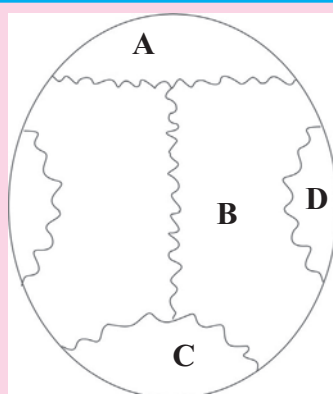
**Ethmoid bone :** This median bone is spongy in appearance. It is located anterior to sphenoid and posterior to nasal bones. It contributes to formation of nasal septum and is major supporting structure of nasal cavity.

In this chapter you are going to learn about sutures, a type of immovable joints. In skull there are many sutures present; four prominent ones are;

1. Coronal suture : Joins frontal bone with parietals.
2. Sagittal suture : Joins two parietal bones.
3. Lambdoidal suture : Joins two parietal bones with occipital bone.
4. Lateral/squamous sutures : Joins parietal and temporal bones on lateral side.

**Identify and label**

Name A, B, C and D from the given figure and discuss in group.



**Axial skeleton :**

<b>Skull</b>	
Cranium	8
Face	14
<b>Hyoid</b>	
	1
<b>Ear ossicles</b>	
	6
<b>Vertebral column</b>	
	26
<b>Thorax</b>	
Sternum	1
Ribs	24
-----	
<b>Subtotal : 80</b>	
-----	
<b>Appendicular skeleton</b>	
-----	
<b>Pectoral Girdle</b>	
Clavicle	2
Scapula	2
<b>Upper Limbs</b>	
Humerus	2
Radius	2
Ulna	2
Carpals	16
Metacarpals	10
Phalanges	28
<b>Pelvic Girdle</b>	
Hip bone	2
<b>Lower Limbs</b>	
Femur	2
Patella	2
Tibia	2
Fibula	2
Tarsals	14
Metatarsals	10
Phalanges	28
-----	
<b>Subtotal : 126</b>	
-----	
<b>Total : 206</b>	

**Table 16.10 Details of Human Skeleton**



### Do you know ?

If there is a newborn in the family, you are told not to touch the head as it is still soft. Have you seen it? Why is it so? There are six soft spots called fontanelles in cranial bones. Eventually they get ossified at the age of two. Fontanelles provide some flexibility to skull during birth and also for rapid growth of brain during infancy.

**Facial Bones :** Fourteen facial bones give characteristic shape to face. Growth of face stops at the age of 16. Facial bones are as under :

**Nasals :** Paired bones form bridge of nose.

**Maxillae :** Upper jaw bones, paired bones that join with all facial bones except mandible. Upper row of teeth are lodged in these.

**Palatines :** Paired bones, form roof of buccal cavity or floor of nasal cavity.

**Zygomatic bones :** Commonly called cheek bones. You have read about zygomatic arch earlier in this chapter.

**Lacrimal bones :** Smallest of the facial bones. These bones form medial wall of each orbit. They have lacrimal fossa that houses lacrimal sacs. These sacs gather tears and send them to nasal cavity.

**Inferior nasal conchae :** They form part of lateral wall of nasal cavity. These help swirl and filter air before it passes to lungs.

**Vomer :** Median, roughly triangular bone that forms inferior portion of nasal septum.

**Mandible :** Median bone that forms lower jaw. Largest and strongest facial bone. Only movable bone of skull. It has curved horizontal body and two perpendicular branches i.e. rami. These help in attachment of muscles. It has lower row of teeth lodged in it.

**Hyoid bone :** It is a 'U' shaped bone that does not articulate with any other bone. It is suspended from temporal bone by ligaments and muscles. It is located between mandible and larynx. It has horizontal body and paired projections called horns. It provides site for attachment of some tongue muscles and muscles of neck and pharynx.

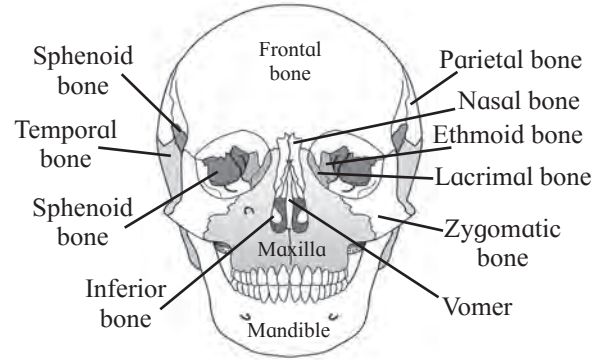


Fig. 16.11 Anterior view of skull



### Internet my friend

Cleft palate and cleft lip.

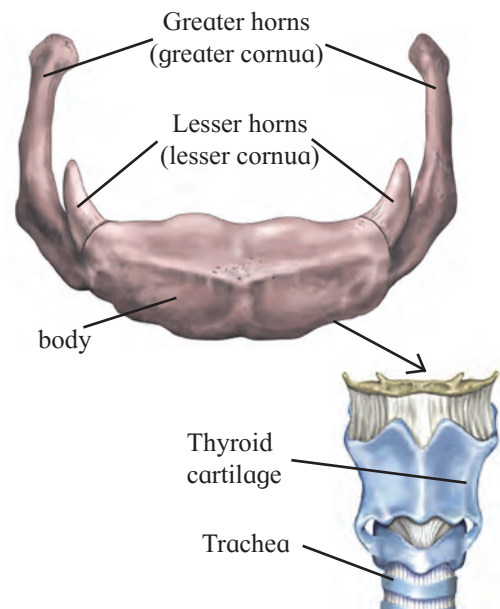


Fig. 16.12 Hyoid bone



### Can you tell?

1. Give schematic plan of human skeleton.
2. Enlist the bones of cranium.
3. Write a note on structure and function of skull.

**Something interesting :** If Police suspect strangulation, they carefully inspect hyoid bone and cartilage of larynx. These get fractured during strangulation. Various such investigations are done in case of suspicious death of an individual where ossification of sutures in skull, width of pelvic girdle, etc. are examined to find out approximate age of victim or gender of victim, etc. You may find out information about forensic science.



**Internet my friend**

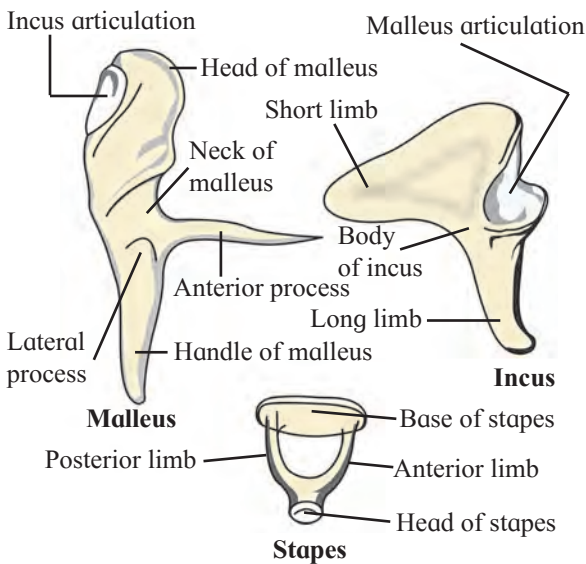
Find out information about sinuses present in skull, functions of skull and disorder 'sinusitis'.



**Can you Tell?**

Why skull is important for us? Enlist few reasons.

**Ear ossicles :** Three tiny bones namely malleus, incus and stapes, together called 'ear ossicles' are present in each middle ear.



**Fig. 16.13 Ear ossicles**

**Vertebral Column :**

Human backbone or vertebral column is made up of a chain of irregular bones called vertebrae. It consists of 33 vertebrae during childhood. In adults, five sacral vertebrae fuse to form one sacrum and four coccygeal vertebrae fuse to form single coccyx, thus total number of bones are 26.



**Try this**

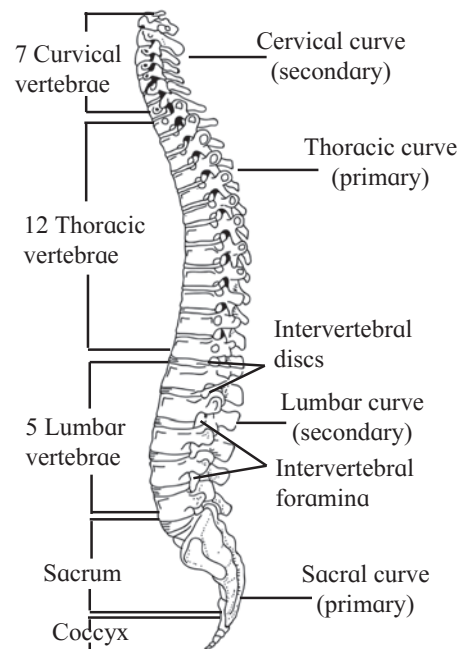
Feel your spine (vertebral column). Is it straight or curved?

There are four curvatures in human spine, cervical and lumbar curves are secondary and convex whereas thoracic and sacral curvatures are primary and concave. Curvatures help in balancing in upright position, absorb shocks while walking and also protect vertebrae from fracture.

**You will study about intervertebral discs in this chapter. Find information about slipped disc.**

There are five types of vertebrae in human spine namely, 7 cervical (neck), 12 Thoracic (chest), 5 lumbar (abdominal), 5 sacral (hip region, fused in adults forming 1 sacrum) and 4 coccygeal (fused to form vestigial tail bone called coccyx).

Though vertebrae vary in size, shape or processes, they exhibit similar basic plan.



**Fig. 16.14 Vertebral column lateral view**

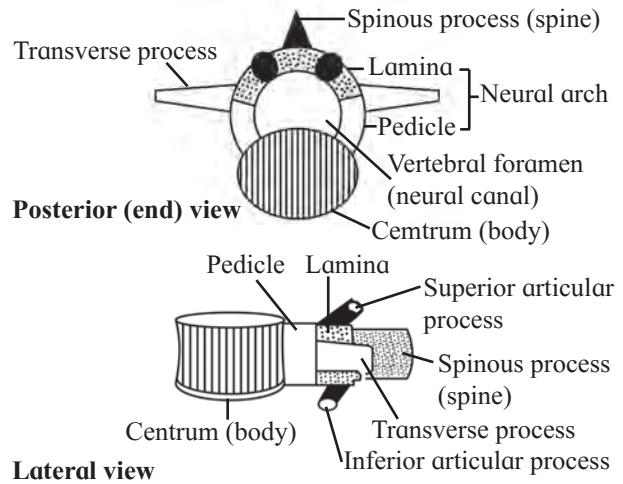
### Typical Vertebra :

Each vertebra has prominent central body called centrum. Centra of human vertebrae are flat in antero-posterior aspect. Hence human vertebrae are amphiplatyan. From either side of centrum are given out two short, thick processes which unite to form an arch like structure called neural arch, posterior to centrum. Neural arch forms vertebral foramen which surrounds the spinal cord. Vertebral foramina of all vertebrae form a continuous 'neural canal'. Spinal cord along with blood vessels and protective fatty covering passes through neural canal.

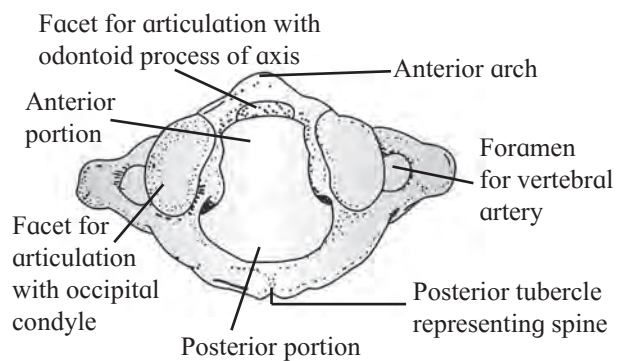
Point where two processes of centrum meet, neural arch is drawn into a spinous process called neural spine. From the base of neural arch, two articulating processes called zygapophyses are given out on either side. The anterior are called superior and posterior called inferior zygapophyses. In a stack of vertebrae, inferior zygapophyses of one vertebra articulates with superior zygapophyses of next vertebra. This allows slight movement of vertebrae without allowing them to slip off. At the junction of zygapophyses, a small opening is formed on either side of vertebra called intervertebral foramen that allows passage of spinal nerve. From the base of neural arch, lateral processes are given out called transverse processes. Neural arch, neural spine and transverse processes are meant for attachment of muscles.

Let us now study modifications seen in vertebrae in different regions of vertebral column.

**Atlas vertebra :** This is a ring like 1<sup>st</sup> cervical vertebra. It consists of anterior and posterior arches. It does not have centrum and spinous process. Transverse processes and transverse foramina are large. Vertebral foramen is large and divided into two parts by transverse ligament. Spinal cord passes through anterior compartment. Anterior zygapophyses, are replaced by facets for attachment with occipital condyle of skull that forms 'Yes Joint'.

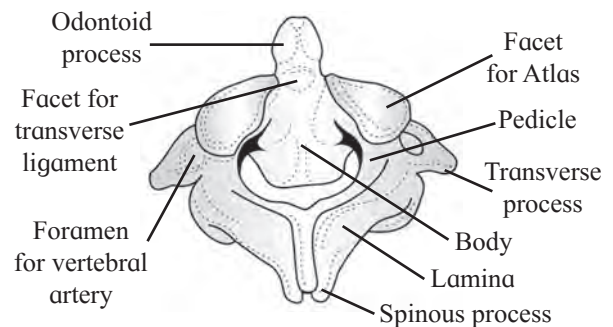


**Fig. 16.15 Basic plan of vertebra**



**Fig. 16.16 Atlas vertebra**

**Axis vertebra :** This is the second cervical vertebra. Centrum of this vertebra gives out tooth-like 'Odontoid Process'. This process fits into the anterior portion of vertebral foramen of Atlas vertebra forming pivot joint, also called 'No joint'.

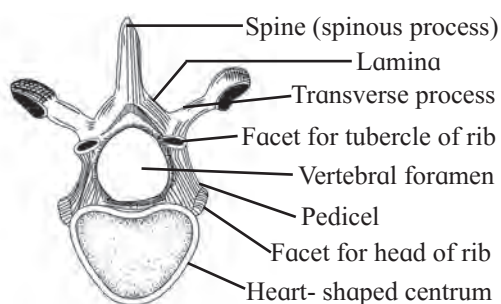


**Fig. 16.17 Axis vertebra**

**Typical cervical vertebrae :** Vertebrae number 3 to 6 are called typical cervical vertebrae. They show short centrum and bifid spinous process. Transverse processes of these vertebrae are reduced; each having large vertebral arterial canal at its base for passage of vertebral artery.

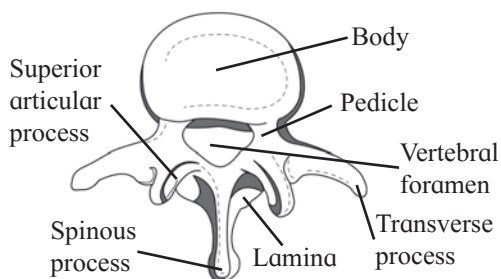
**7<sup>th</sup> cervical vertebra (*Vertebra prominens*) :** It is the largest cervical vertebra where neural spine straight.

**Thoracic vertebra :** These are twelve in number and found in chest region. Centrum of thoracic vertebrae is heart shaped and all processes are well developed. Except for vertebrae number 11, 12; transverse process of other thoracic vertebrae show facets for attachment with ribs.



**Fig. 16.18 Thoracic vertebra**

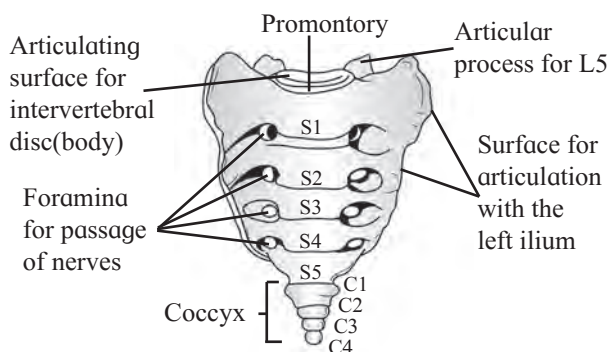
**Lumbar vertebra :** There are five lumbar vertebrae. These are well developed vertebrae that exhibit all characters of a typical vertebra. Centrum is kidney shaped.



**Fig. 16.19 Lumbar vertebra**

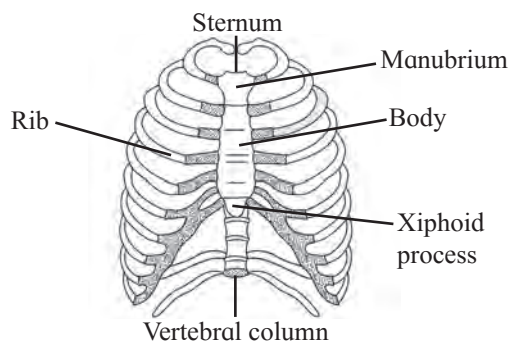
**Sacrum :** Sacrum is a triangular bone formed by fusion of five sacral vertebrae. It is located in pelvic cavity between two hip bones. Anterior end of sacrum is broad and posterior end is narrow. Vertebral foramina that are formed by fusion of vertebrae can be seen. Reduced neural spines can be observed projecting from dorsal aspect of sacrum. It gives strength to pelvic girdle.

**Coccyx :** Coccyx is formed by fusion of four coccygeal vertebrae. It is reduced and does not show vertebral foramina and spinous processes. Transverse processes of coccygeal vertebrae are reduced. It is a triangular bone.



**Fig. 16.20 Sacrum and Coccyx**

**Thoracic cage :** It consists of twelve thoracic vertebrae; which are already discussed; twelve pairs of ribs and breast bone, the sternum.



**Fig. 16.21 Thoracic cage**



**Can you tell?**

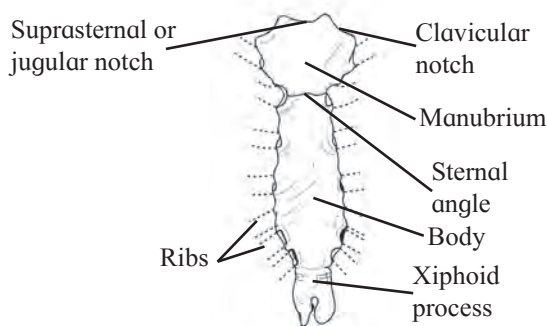
1. Explain the structure of a typical vertebra.
2. How will you identify a thoracic vertebra?
3. Write a note on curvatures of vertebral column and mention their importance.

**Sternum :** It is a flat, narrow bone, around 15 cms in length. It is placed medially in anterior thoracic wall (chest region). It consists of three distinct parts-manubrium, body and xiphoid processes.

Manubrium shows two notches on antero-lateral side for attachment with clavicle of each side. It also shows two notches on each of the lateral side for attachment of first two pairs of ribs.

Body of sternum is a flat bone that shows five notches on lateral aspect which are meant for direct or indirect attachment of ribs. Ribs are attached to sternum by means of cartilaginous extensions called costal cartilages.

Xiphoid process is lowermost part of sternum which is cartilaginous initially and gets ossified in adults. It provides space for attachment of diaphragm and abdominal muscles.



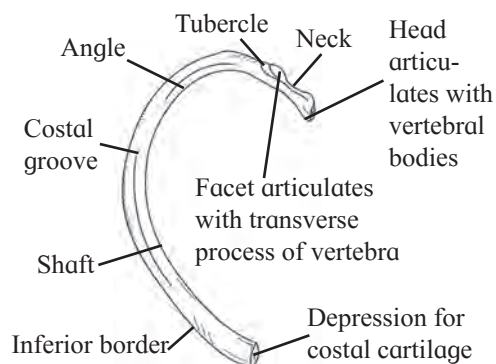
**Fig. 16.22 Sternum**

**Rib :** A rib is a 'C' shaped bone that is attached to respective thoracic vertebrae on dorsal side. Twelve pairs of ribs are attached to twelve thoracic vertebrae. For this attachment, posterior ends of ribs have two protuberances namely the head and tubercle. The head of rib attaches to facet formed by demifacets of adjacent thoracic vertebrae at the base of transverse processes. Tip of transverse processes of these vertebrae also have facets for attachment of ribs where tubercles of ribs are attached.

On the ventral side, the ribs may or may not attach to the sternum. Depending on their attachment, ribs are classified into three types.

- i. True ribs :** First seven pairs of ribs are attached directly to the sternum by means of their costal cartilages.
- ii. False ribs :** Costal cartilages of ribs no. 8, 9 and 10 are attached to rib number 7 on either side and not directly to the sternum. Hence these are called false ribs.
- iii. Floating ribs :** Last two pairs of ribs have no ventral connection. Hence are called floating ribs.

Space between ribs is called intercostal space. Ribs provide space for attachment of intercostal muscles.



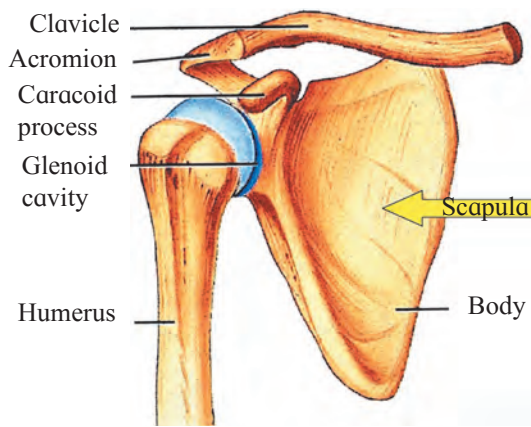
**Fig. 16.23 Rib**

**Something interesting :**

Approximately 8 % of humans have an extra pair of ribs attached to the lumbar vertebra. Such a rib is found in some types of gorillas. Hence 13<sup>th</sup> pair of ribs is called gorilla rib.

**B. Appendicular skeleton :** As mentioned earlier in this chapter, appendicular skeleton consists of bones of limbs and girdles.

**Pectoral girdle :** Also called shoulder girdle, it attaches forelimb skeleton with axial skeleton. There are two pectoral girdles, each consists of a shoulder blade or scapula and collar bone or clavicle.



**Fig. 16.24 Pectoral girdle**

**Clavicle :** It is 's' shaped slender bone. One end of clavicle is attached to acromion process of scapula. The other rounded end called sternal end attaches to manubrium of sternum. This connects upper arm skeleton to axial skeleton.

**Scapula :** It is a large, flat, triangular bone that occupies posterior chest wall extending from second to seventh ribs. It is attached to axial skeleton by muscles and tendons.

At its lateral angle, scapula bears a concave socket called glenoid cavity. Head of humerus (the upper arm bone) fits into the glenoid cavity. Two processes arise from scapula, a beak like coracoid process that projects from lateral angle of scapula and acromion process, easily felt as high point of shoulder. Both are meant for attachment of muscles.

**Bones of forelimb :** It consists of humerus, radius and ulna (together forming forearm bones), Bones of wrist-the carpals, bones of palm-the metacarpals and bones of digits-phalanges together making to 30 bones.



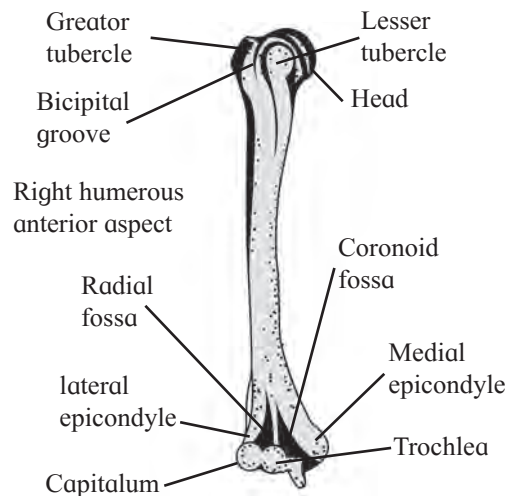
**Can you recall?**

How does humerus form ball and socket joint? Where is it located ?

**Humerus :** This is the bone of upper arm. It has hemispherical head at its proximal end.

On either side of head of humerus are present a pair of projections termed greater and lesser tubercles. There is a deep groove between the tubercles called bicipital groove where a tendon of biceps muscle is attached.

Shaft of humerus shows deltoid tuberosity. Distal end of humerus shows pulley like part called trochlea that articulates with ulna.



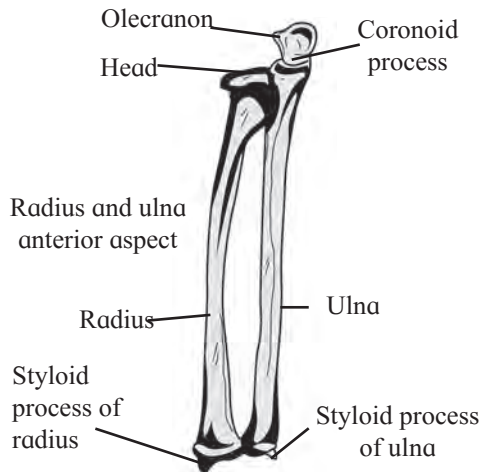
**Fig. 16.25 Humerus**

**Radius and Ulna :** Radius is located laterally on thumb side of the forearm. Proximal end of radius has disc like head that articulates with humerus bone. The shaft of radius widens distally to form styloid process.

Ulna is located medially on little finger side of forearm. At the proximal end of ulna there is a prominent process called 'Olecranon process' that forms elbow joint with humerus bone. On the lateral side, near the upper end of ulna is present the radial notch into which the side of head of radius is fixed.

Radius and ulna articulate with each other at upper and lower extremities by superior and inferior radio-ulnar joints. In between the shaft of two bones, interosseous membrane is present.



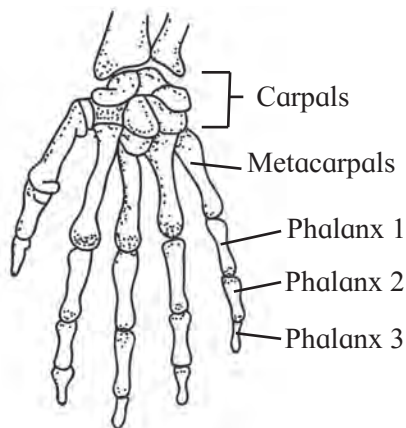


**Fig. 16.26 Radius and Ulna**

**Carpals :** These are bones of wrist, arranged in two rows of four each.

**Metacarpals :** Five elongated metacarpals form bones of palm. Their proximal ends join with carpals and distal ends form knuckles.

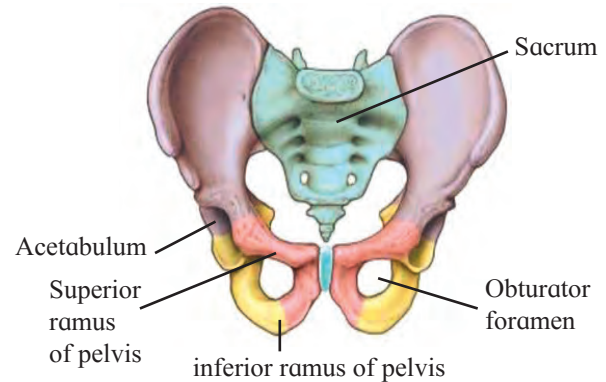
**Phalanges :** These are bones of fingers and thumb. Four fingers have three phalanges each and thumb has two; thus making it fourteen phalanges in each hand.



**Fig. 16.27 Carpals, Metacarpals and Phalanges**

**Pelvic girdle :** Pelvic or hip girdle connects hind limb skeleton with axial skeleton. It is made up of two hip bones called coxal bones. They unite posteriorly with sacrum. Each large irregularly shaped bone, the coxal bone is made up of three parts, ilium, ischium and pubis. At the point of fusion of three bones, a cavity called acetabulum is present that forms ball and socket joint with thigh bone.

The two pubis bones are joined medially by cartilaginous joint called pubic symphysis. Pubis and ischium together form a ring of bone that encloses a space called obturator foramen.

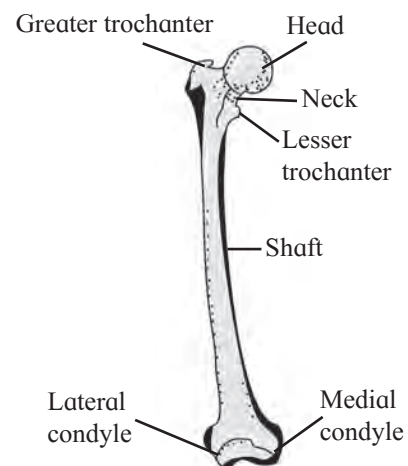


**Fig. 16.28 Pelvic girdle**

**Bones of lower limb :**

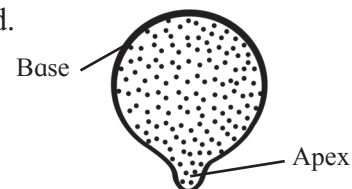
**Femur :** The thigh bone is the longest a bone in the body. The head is joined to shaft at an angle by a short neck. It forms ball and socket joint with acetabulum cavity of coxal bone.

The lower one third region of shaft is triangular flattened area called popliteal surface. Distal end has two condyles that articulate with tibia and fibula.



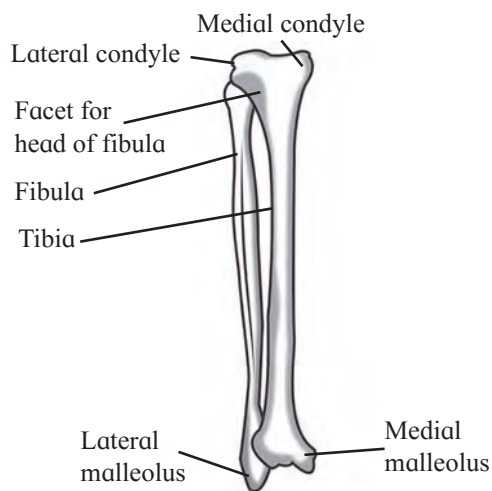
**Fig. 16.29 Femur**

**Patella :** Also called knee cap is a sesamoid bone. It is a flat rounded bone with a pointed lower end.



**Fig. 16.30 Patella**

**Tibia and fibula :** These are the two long bones of shank or lower leg. The two are connected to each other at the extremities. In between the two bones interosseous membrane is present.

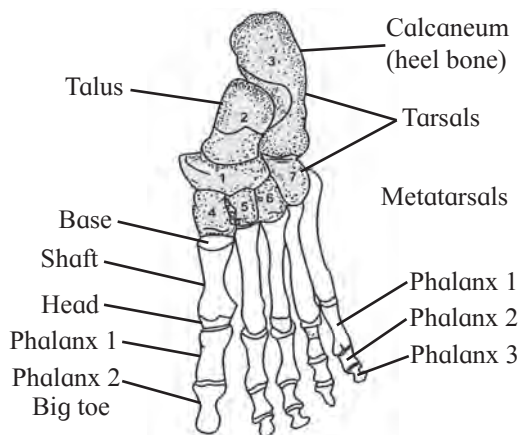


**Fig. 16.31 Tibia and Fibula**

**Tibia :** It is much thicker and stronger than fibula. It's broad and expanded upper end articulates with femur. Lower end articulates with talus, a tarsal bone.

**Fibula :** It is a long slender bone on lateral side of tibia.

**Tarsals :** These are the bones of ankle. Seven tarsals are arranged in three row, two proximal, one intermediate and four distal.



**Fig. 16.32 Tarsals, Metatarsals and phalanges**

**Metatarsals :** Five metatarsal bones support the sole region of the foot. Proximally they attach with distal row of tarsals. Distally metatarsals articulate with phalanges.

**Phalanges :** These are the bones of the toes. Except the big toe which has two phalanges, rest four toes have three phalanges each.



**Can you tell?**

1. Differentiate between skeleton of palm and foot.
2. Explain the longest bone in human body.



**Do you remember?**

1. What are joints? What are their types?
2. What types of joint is present at knee?

**Imagine**

If your elbow joint would be a fixed type of joint and joint between teeth and gum would be freely movable.

**16.10 Types of joints :**

You have studied about joints in previous standard. Without joints, various movements of the body wouldn't be possible.

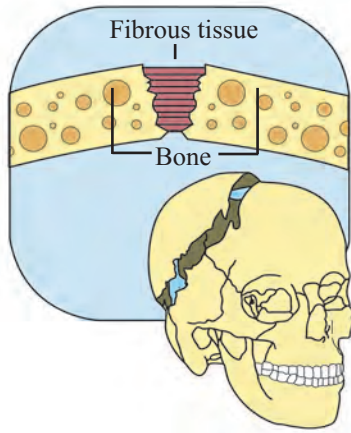
A point where two or more bones get articulated is called joint or articulation or arthrosis. Study of joints is called arthrology.

Though bones are rigid, the ligaments that cover the bones, forming a joint render slight flexibility to the bones.

Joints are classified based on degree of flexibility or movement they permit into three types namely, fibrous joints, which are also known as synarthroses or immovable joints, cartilagenous or slightly movable joints also called amphiarthroses and lastly synovial or freely movable or diarthroses type of joints.

Degree of movement of joints in various parts of your body is so apt! We must always appreciate the design of our body.

**Synarthroses :** In this joint, the articulating bones are held together by means of fibrous connective tissue. Bones do not exhibit movement. Hence it is immovable or fixed type of joint.



**Fig. 16.33 Structure of Sutures**

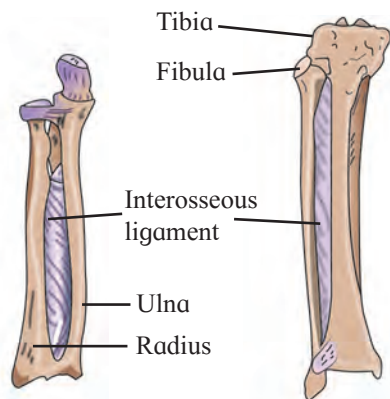
Type of suture	Character	Diagram	Example
Butt joint	Square edged		Two nasal bones
Scarf joint	Tapering		Various skull bones
Lap joint	Over lapping		Temporal and parietal bone
Serrate joint	Irregular/Interlocking		Various skull bones

**Table 16.34 Types of Sutures**

Fibrous joints are further classified into sutures, syndesmoses and gomphoses.

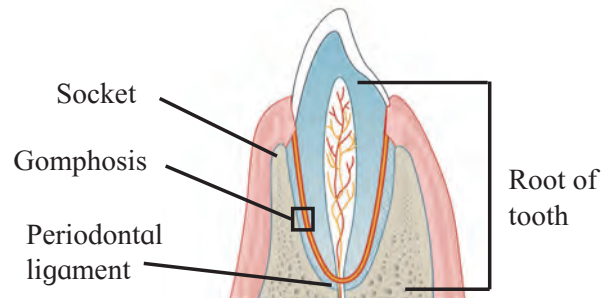
**Sutures :** It is composed of thin layer of a dense fibrous connective tissue. Sutures are places of growth. They remain open till growth is complete. On completion of growth they tend to ossify. Sutures may permit some moulding during childhood. Sutures are further classified into different types as shown in Table 16.34.

**Syndesmoses :** It is present where there is greater distance between articulating bones. At such locations, fibrous connective tissue is arranged as a sheet or bundle. e.g. Distal tibiofibular ligament, inter osseous membrane between tibia and fibula and that between radius and ulna.



**Fig. 16.35 Syndesmoses**

**Gomphoses :** In this type of joint a cone shaped bone fits into a socket provided by other bone. e.g. Tooth and jaw bones.

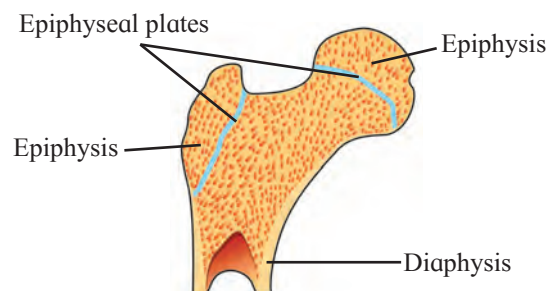


**Fig. 16.36 Gomphoses**

**A. Cartilagenous or slightly movable joints :**

These are also called as **amphiarthroses**. These joints are neither fixed nor freely movable. Articulating bones are held together by hyaline or fibrocartilages. They are further classified as

**a. Synchondroses :** The two bones are held together by hyaline cartilage. They are meant for growth. On completion of growth, the joint gets ossified. Example: Epiphyseal plate found between epiphysis and diaphysis of a long bone, Rib – Sternum junction.



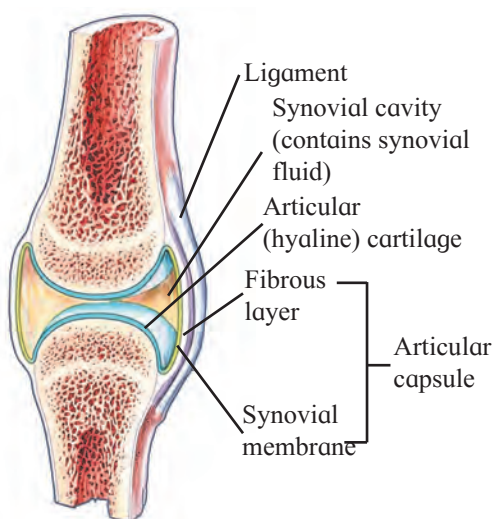
**Fig. 16.37 Synchondroses**

**b. Symphysis :** In this type of joint, broad flat disc of fibrocartilage connects two bones. These occur in midline of the body. One example of this type of joint is intervertebral discs. Can you write another example?

### B. Synovial joints or freely movable joints :

They are also called as **diarthroses**.

It is characterized by presence of a space called synovial cavity between articulating bones that renders free movement at the joint. Articulating surfaces of bones at a synovial joint are covered by a layer of hyaline cartilage. (Bones do not touch to each other). It reduces friction during movement and helps to absorb shock. Synovial cavity is lined by synovial membrane that forms synovial capsule. Synovial membrane secretes synovial fluid.

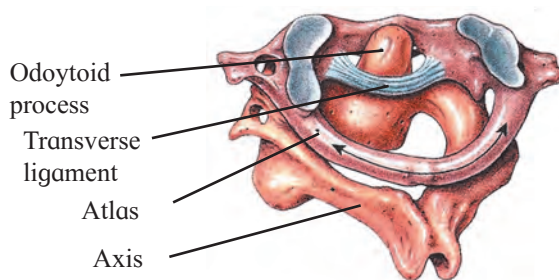


**Fig. 16.38 Synovial joint**

Synovial fluid is a clear, viscous, straw coloured fluid similar to lymph. It is viscous due to hyaluronic acid. Fluid also contains nutrients, mucous and phagocytic cells to remove microbes. Synovial fluid lubricates the joint, absorbs shocks, nourishes the hyaline cartilage and removes waste materials from hyaline cartilage cells (as cartilage is avascular) phagocytic cell destroy microbes and cellular debris formed by wear and tear of the joint.

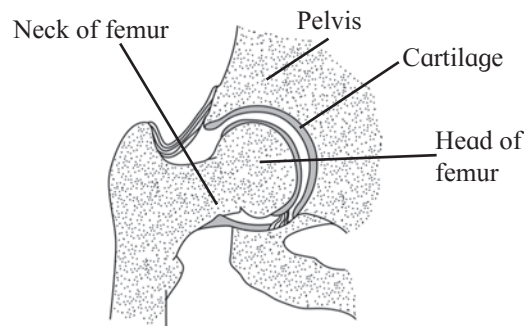
If the joint is immobile for a while, the synovial fluid becomes viscous and as joint movement starts, it becomes less viscous. The joint is provided with capsular ligament and numerous accessory ligaments. The fibrous capsule is attached to periosteum of articulating bones. The ligament helps in avoiding dislocation of joint. Let us study types of synovial joints. Note that any type of synovial joint will show above mentioned components.

**Pivot joint :** Here, the rounded or pointed surface of one bone articulates with a ring formed partly by another bone and partly by ligament. Rotation only around it's own longitudinal axis is possible. Example : In joint between atlas and axis vertebrae, head turns side ways to form 'NO' joint.



**Fig. 16.39 Pivot joint**

**Ball and socket joint :** Ball like surface of one bone fits into cup like depression of another bone forming a moveble joint. Multiaxial movements are possible. This type of joint allows movements along all three axes and in all directions. Example : Shoulder and hip joint



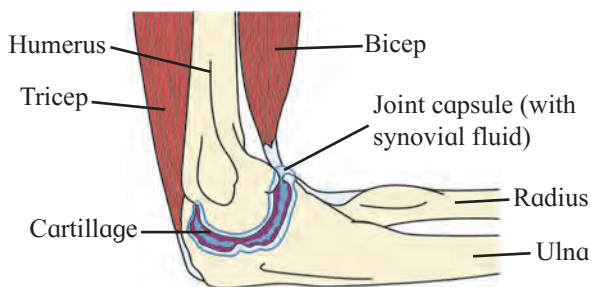
**Fig. 16.40 Ball and socket joint**



**Use your brain power**

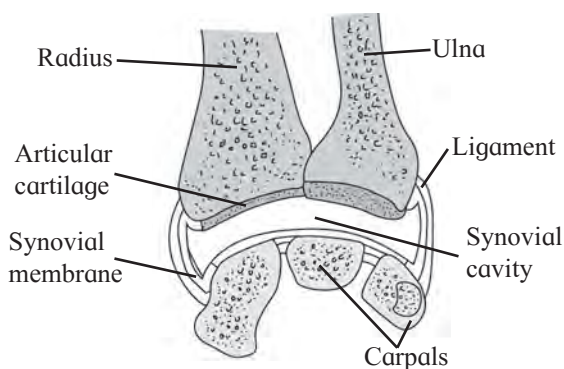
Why are warming up rounds essential before regular exercise?

**Hinge joint :** In a hinge joint, convex surface of one bone fits into concave surface of another bone. In most hinge joints one bone remains stationary and other moves. Angular, opening and closing motion like that of a hinge is possible. In this joint only monoaxial movement takes place like flexion and extension. Example : Elbow and knee joint.



**Fig. 16.41 Hinge joint**

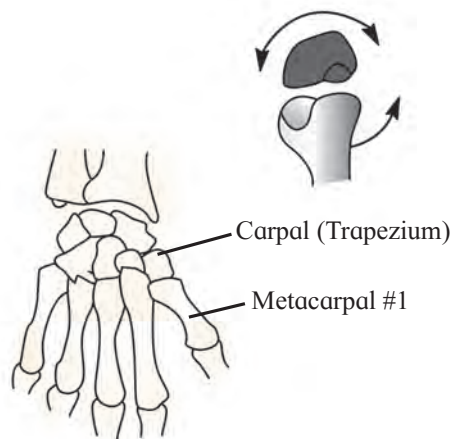
**Condyloid joint :** It is an ellipsoid joint. The convex oval shaped projection of one bone fits into oval shaped depression in another bone. It is a biaxial joint because it permits movement along two axes viz. flexion, extension, abduction, adduction and circumduction is possible. Example : Metacarpophalangeal joint



**Fig. 16.42 Condyloid joint between radius and carpals**

**Gliding joint :** A planar joint, where articulating surfaces of bones are flat or slightly curved. These joints are non-axial because motion they allow does not occur along an axis or a plane. Example : Intercarpal and intertarsal joints.

**Saddle joint :** This joint is a characteristic of *Homo sapiens*. Here, articular surface of one bone is saddle-shaped and that of other bone fits into such saddle as a sitting rider would sit. i.e. each bone has both concave and convex areas. It is a modified condyloid joint in which movement is somewhat more free. It is a biaxial joint that allows flexion, extension, abduction, adduction and circumduction. Example : Carpometacarpellar joint between trapezium carpal and metacarpal of thumb.



**Fig. 16.43 Saddle joint**



**Can you tell?**

1. Classify various type of joints found in human body. Present the information in the form of chart. Give examples of each type.
2. Human beings can hold an object in a better manner than monkeys. Why?
3. What makes the synovial joint freely moveable?



**Internet my friend**

Now a days we hear from many elderly people that they are undergoing knee replacement surgery. Find out why one has to undergo knee replacement; how it is carried out and how it can be prevented.

### 16.11 Disorders related to muscles :

**Muscular dystrophy :** It is a gradual wasting disease affecting various groups of muscles. These are genetically inherited in families. Usually voluntary skeletal muscles are weakened whereas internal muscles such as diaphragm are not affected. Duchenne type usually occurs in boys affecting lower limbs. Limb girdle muscular dystrophy affects the muscles of shoulders or hips and it usually starts in adults of 20-35 years. No treatment appears to cure the disease.

**Myasthenia gravis :** It is a weakness of skeletal muscles. It is caused by an abnormality at the neuromuscular junction that partially blocks contraction. It is an autoimmune disorder caused by an excess of certain antibodies in the blood stream. Antibodies bind to acetylcholine receptors of neuromuscular junction. Thus transmission of nerve impulses to the muscle fibres is blocked. This causes progressive and extensive muscle weakness. It may affect the eye and eyelid movements, facial expression and swallowing. The degree of muscle weakness varies from local to general. Example of symptoms are – Ptosis, (diplopia or double vision) difficulty in swallowing, chewing and speech.

### 16.12 Disorders related to bones :

**Arthritis :** It is an inflammation of joints. It is a painful disorder of bones, ligaments tendons etc. In this disorder, joints become swollen, stiff and painful. It can lead to disability. Arthritis is of three types.

- i. **Osteoarthritis :** In this, joint cartilage is degenerated. It is caused by various factors like aging, obesity, muscle weakness, etc. This is most common type of arthritis that affects hands, knees and spine.
- ii. **Gouty arthritis (Gout) :** In this disorder joint pain occurs due to deposition of uric acid in joints. If uric acid is produced in excess or is not excreted, it accumulates in joints as sodium urate and degenerates cartilage, causing inflammation and pain. It generally affects joints of feet.

- iii. **Rheumatoid arthritis :** It is an autoimmune disorder where body's immune system attacks its own tissues. In rheumatoid arthritis, synovial membrane swells up and starts secreting extra synovial fluid. This fluid exerts pressure on joint and makes it painful. Membrane may develop abnormal granulation tissue called pannus. Pannus may erode cartilage. Fibrous tissue gets ossified and may lead to stiffness in joints.



#### Find out

You must have heard of Sachin Tendulkar suffering from 'tennis elbow', a cricketer suffering from a disorder named after another game. Can common people too suffer from this disorder?

Find out more information about this disorder.



#### Internet my friend

Find out information about types of fractures and how they heal.

**Osteoporosis :** In this disorder, bones become porous and hence brittle. It is primarily age related disease more common in women than men. As age advances, bone resorption outpaces bone formation hence bones loose mass and become brittle. More calcium is lost in urine, sweat etc. than it is gained through diet. Hence prevention of disease is better than treatment by consuming adequate amount of calcium and exercise at young age. Osteoporosis may be caused due to decreasing estrogen secretion after menopause, deficiency of vitamin D, low calcium diet, decreased secretion of sex hormones and thyrocalcitonin.

Apart from fractures, osteoporosis may lead to shrinkage of vertebrae, height loss, hunched back and bone pain.



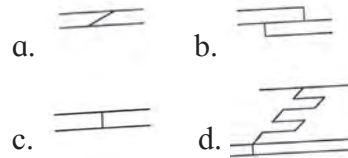
## Exercise

### 1. Choose the correct option

- A. The functional unit of striated muscle is .....
- a. cross bridges                      b. myofibril  
c. sarcomere                          d. z-band
- B. A person slips from the staircase and breaks his ankle bone. Which bones are involved?
- a. Carpals                              b. Tarsal  
c. Metacarpals                      d. Metatarsals
- C. Muscle fatigue is due to accumulation of .....
- a. pyruvic acid                      b. lactic acid  
c. malic acid                          d. succinic acid
- D. Which one of the following is NOT antagonistic muscle pair?
- a. Flexo-extensor  
b. Adductor-abductor  
c. Levator-depressor  
d. Sphincter-supinator
- E. Swelling of sprained foot is reduced by soaking in hot water containing a large amount of common salt,
- a. due to osmosis  
b. due to plasmolysis  
c. due to electrolysis  
d. due to photolysis
- F. Role of calcium in muscle contraction is .....
- a. to break the cross bridges as a cofactor in the hydrolysis of ATP  
b. to bind with troponin, changing its shape so that the actin filament is exposed  
c. to transmit the action potential across the neuromuscular junction.  
d. to re-establish the polarisation of the plasma membrane following an action potential

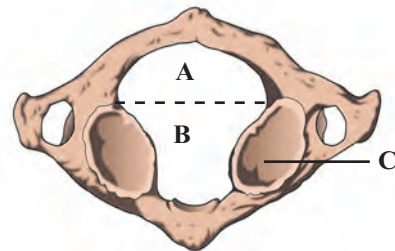
- G. Hyper-secretion of parathormone can cause which of the following disorders?
- a. Gout                                  b. Rheumatoid arthritis  
c. Osteoporosis                      d. Gull's disease

- H. Select correct option between two nasal bones



### 2. Answer the following questions

- A. What kind of contraction occurs in your neck muscles while you are reading your class assignment?
- B. Observe the diagram and enlist importance of 'A', 'B' and 'C'.



- C. Raju intends to train biceps; while exercising using dumbbells, which joints should remain stationary and which should move?
- D. In a road accident, Moses fractured his leg. One of the passers by, tied a wooden plank to the fractured leg while Moses was rushed to the hospital. Was this essential? Why?
- E. Sprain is more painful than fracture. Why?
- F. Why a red muscle can work for a prolonged period whereas white muscle fibre suffers from fatigue after a shorter work? (Refer to chapter animal tissues.)

### 3. Answer the following questions in detail

- A. How is the structure of sarcomere suitable for the contractility of the muscle? Explain its function according to sliding filament theory. (Refer to chapter animal tissues.)
- B. Ragini, a 50 year old office goer, suffered hair-line cracks in her right and left foot in short intervals of time. She was worried about minor jerks leading to hair line cracks in bones. Doctor explained to her why it must be happening and prescribed medicines.

What must be the cause of Ragini's problem? Why has it occurred? What precautions she should have taken earlier? What care she should take in future?

- C. How does structure of actin and myosin help muscle contraction?
- D. Justify the structure of atlas and axis vertebrae with respect to their position and function.
- E. Observe the blood report given below and diagnose the possible disorder.

### 4. Write short notes on following points

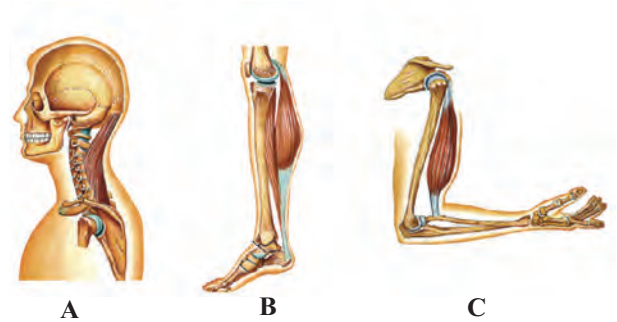
- A. Actin filament  
 B. Myosin filament  
 C. Role of calcium ions in contraction and relaxation of muscles.

### 5. Draw labelled diagrams

- A. Synovial joint.  
 B. Different cartilagenous joints.

### Practical / Project :

Identify the following diagrams and demonstrate the concepts in classroom.



Report D		
PERFECT PATHOLOGY	Reg. No. : _____	
Dr. _____	Date: _____	
Patient Name : _____	Age: _____	M/F
Reference:		
<b>Examination of Blood</b>		
Test	Result	Normal value
Uric Acid	9.2	2.5 - 7.0 mg/l
Blood Urea Nitrogen (Bun)	24	10 - 20 mg/dl



## Reference (Book list)

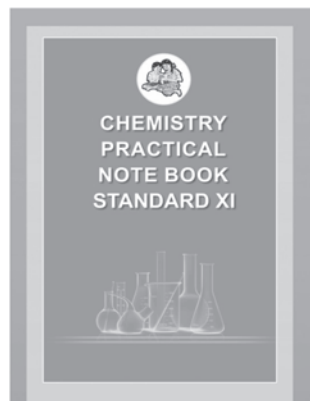
1. Textbook of Medical Physiology (11<sup>th</sup> edition, 2006) Guyton and Hall. - Elsevier Saunders.
2. Principles of Anatomy and Physiology (13<sup>th</sup> edition) Tortora and Derrickson. - John Wiley and sons.
3. The Insects - Structure and Function (5<sup>th</sup> edition) R. F. Chapman- Cambridge University Press.
4. IMM's General Textbook of Entomology (Vol-I) (10<sup>th</sup> edition) Richard and Davies. - Chapman and Hall, John Wiley and Sons.
5. Anatomy and Physiology in Health and Illness (9<sup>th</sup> edition, 2004) Waugh, A. and Grant, A.- Churchill Livingstone.
6. Cell and Molecular Biology (1987) - E. D. P. DeRobertis and E.M.P. DeRobertis. - Lea and Febiger, USA.
7. Cell Biology (3<sup>rd</sup> edition, 1983) - C. B. Powar, Himalaya Publisher.
8. Advanced Biology- Principles and Applications (2<sup>nd</sup> edition, 2008) C. J. Clegg, Hodder edition.
9. Basic Botany (1971) (1<sup>st</sup> edition) - Mridula Datta - Allied Publication.
10. Plant Physiology (3<sup>rd</sup> edition, 2002) Taiz and Zeiger, - Sinauer Associates.
11. Plant Physiology (4<sup>th</sup> edition) Pandey and Sinha, Vikas Publisher.
12. Plant Classification (2<sup>nd</sup> edition, 1976) Lyman Benson - Oxford and IBH Publisher.
13. Advanced Plant Taxonomy (2016), A. K. Mondal, New Central Book Age.
14. Plant Physiology (1986) Salisbury and Ross, CBS Publishers.
15. Biology for IB DIPLOMA (2007), C. S. CLEGG, HODDER Edition.
16. Biology for Cambridge International AS and A Level - C. J. Clegg - Cambridge.
17. Biology Course Book (3<sup>rd</sup> edition) Jones, Fosbery, et. al, (2013) - Cambridge.
18. Principles of Biochemistry (4<sup>th</sup> edition, 2004), Nelson and Cox W. H. Freeman and Co.
19. Harper's Illustrated Biochemistry (26<sup>th</sup> edition), Murray, et. al, - The McGraw - Hill Co.
20. Molecular Biology of the Cell (5<sup>th</sup> edition), Bruce Alberts, et. al, - Garland Science.
21. Plant Systematics - Michael G. Simpson, Elsevier Aca. Press.
22. A Modern Text book of Zoology - Invertebrates - (2009), R. L. Kotpal. - Rastogi Publications.
23. A Modern Text book of Zoology - Vertebrates - (2009), R. L. Kotpal. - Rastogi Publications.
24. Invertebrates (3<sup>rd</sup> edition), Richard Brusca, et. al, Sinaur Associates Inc.
25. Invertebrates - Britannica Illustrated Science Library.
26. Vertebrates - Comparative Anatomy, Function, Evolution (5<sup>th</sup> edition), - Kenneth V. Kardong, McGraw Hill.



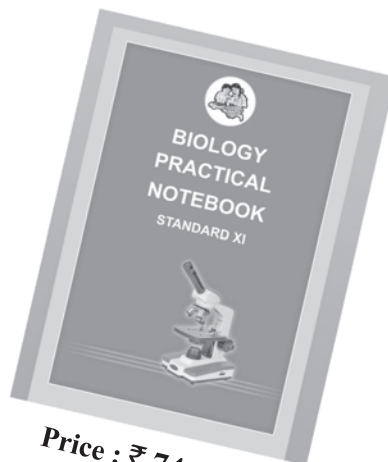
## *Practical Notebook for Standard XI* *Practical Notebook Cum Journal*



Price : ₹ 63.00



Price: ₹ 59.00



Price : ₹ 74.00

- Based on Government approved syllabus and textbook
- Inclusion of all practicals as per Evaluation scheme.
- Inclusion of various activities and objective questions
- Inclusion of useful questions for oral examination
- Separate space for writing answers

***Practical notebooks are available for sale in the regional depots of the Textbook Bureau.***

(1) Maharashtra State Textbook Stores and Distribution Centre, Senapati Bapat Marg, Pune 411004 ☎ 25659465  
(2) Maharashtra State Textbook Stores and Distribution Centre, P-41, Industrial Estate, Mumbai - Bengaluru Highway, Opposite Sakal Office, Kolhapur 416122 ☎ 2468576 (3) Maharashtra State Textbook Stores and Distribution Centre, 10, Udyog Nagar, S. V. Road, Goregaon (West), Mumbai 400062 ☎ 28771842  
(4) Maharashtra State Textbook Stores and Distribution Centre, CIDCO, Plot no. 14, W-Sector 12, Wavanja Road, New Panvel, Dist. Rajgad, Panvel 410206 ☎ 274626465 (5) Maharashtra State Textbook Stores and Distribution Centre, Near Lekhanagar, Plot no. 24, 'MAGH' Sector, CIDCO, New Mumbai-Agra Road, Nashik 422009 ☎ 2391511 (6) Maharashtra State Textbook Stores and Distribution Centre, M.I.D.C. Shed no. 2 and 3, Near Railway Station, Aurangabad 431001 ☎ 2332171 (7) Maharashtra State Textbook Stores and Distribution Centre, Opposite Rabindranath Tagore Science College, Maharaj Baug Road, Nagpur 440001 ☎ 2547716/2523078 (8) Maharashtra State Textbook Stores and Distribution Centre, Plot no. F-91, M.I.D.C., Latur 413531 ☎ 220930 (9) Maharashtra State Textbook Stores and Distribution Centre, Shakuntal Colony, Behind V.M.V. College, Amravati 444604 ☎ 2530965



ebalbharati

E-learning material (Audio-Visual) for Standards One to Twelve is available through Textbook Bureau, Balbharati...

- Register your demand by scanning the Q.R. Code given alongside.
- Register your demand for E-learning material by using Google play store and downloading ebalbharati app.  
[www.ebalbharati.in](http://www.ebalbharati.in), [www.balbharati.in](http://www.balbharati.in)





**Maharashtra State Bureau of Textbook Production and  
Curriculum Research, Pune.**

जीवशास्त्र इयत्ता ११वी (इंग्रजी माध्यम)

₹ 127.00