

DATE : 05/05/2024

Test Booklet Code

S2

UGRID

Answers & Solutions

Time : 3 hrs. 20 Min.

for

M.M. : 720

NEET (UG)-2024

Important Instructions :

- The test is of **3 hours 20 minutes** duration and the Test Booklet contains **200** multiple-choice questions (four options with a single correct answer) from **Physics, Chemistry and Biology (Botany and Zoology)**. 50 questions in each subject are divided into **two Sections (A and B)** as per details given below:
 - Section-A** shall consist of **35 (Thirty-five)** Questions in each subject (Question Nos-1 to 35, 51 to 85, 101 to 135 and 151 to 185). All Questions are compulsory.
 - Section-B** shall consist of **15 (Fifteen)** questions in each subject (Question Nos- 36 to 50, 86 to 100, 136 to 150 and 186 to 200). In **Section B**, a candidate needs to **attempt any 10 (Ten)** questions out of **15 (Fifteen)** in each subject.

Candidates are advised to read all 15 questions in each subject of Section B before they start attempting the question paper. In the event of a candidate attempting more than ten questions, **the first ten questions answered by the candidate shall be evaluated.**
- Each question carries **4 marks**. For each correct response, the candidate will get **4 marks**. For each incorrect response, **one mark** will be deducted from the total scores. **The maximum marks are 720.**
- Use **Blue / Black Ball Point Pen only** for writing particulars on this page / marking responses on Answer Sheet.
- Rough work is to be done in the space provided for this purpose in the Test Booklet only.
- On completion of the test, the candidate must **hand over the Answer Sheet (ORIGINAL and OFFICE copy) to the Invigilator** before leaving the Room / Hall. The candidates are allowed to take away this Test Booklet with them.
- The CODE for this Booklet is S2. Make sure that the CODE printed on the Original Copy of the Answer Sheet is the same as that on this Test Booklet.** In case of discrepancy, the candidate should immediately report the matter to the Invigilator for replacement of both the Test Booklet and the Answer sheet.
- The candidates should ensure that the Answer Sheet is not folded. Do not make any stray marks on the Answer Sheet. Do not write your Roll No. anywhere else except in the specified space in the Test Booklet/Answer Sheet.
- Use of white fluid for correction is **NOT** permissible on the Answer Sheet.
- Each candidate must show on-demand his/her Admission Card to the Invigilator.
- No candidate, without special permission of the Centre Superintendent or Invigilator, would leave his/her seat.
- Use of Electronic/Manual Calculator is prohibited.
- The candidates are governed by all Rules and Regulations of the examination with regard to their conduct in the Examination Room / Hall. All cases of unfair means will be dealt with as per Rules and Regulations of this examination.
- No part of the Test Booklet and Answer Sheet shall be detached under any circumstances.**
- The candidates will write the Correct Test Booklet Code as given in the Test Booklet / Answer Sheet in the Attendance Sheet.

PHYSICS

SECTION-A

1. A horizontal force 10 N is applied to a block A as shown in figure. The mass of blocks A and B are 2 kg and 3 kg respectively. The blocks slide over a frictionless surface. The force exerted by block A on block B is :

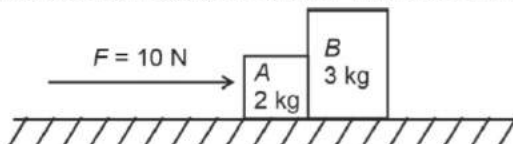

- (1) 10 N
(2) Zero
(3) 4 N
(4) 6 N

Answer (4)

Sol. $F = (M_1 + M_2)a$

$$a = \frac{10}{2+3} = 2 \text{ ms}^{-2}$$

$$F' = M_2(2) = 3 \times 2 \text{ N} = 6 \text{ N}$$

2. ${}_{82}^{290}\text{X} \xrightarrow{\alpha} \text{Y} \xrightarrow{e^+} \text{Z} \xrightarrow{\beta^-} \text{P} \xrightarrow{e^-} \text{Q}$

In the nuclear emission stated above, the mass number and atomic number of the product Q respectively, are

- (1) 286, 81
(2) 280, 81
(3) 286, 80
(4) 288, 82

Answer (1)

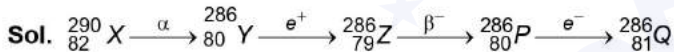

$$A \rightarrow 286$$

$$Z = 81$$

3. Consider the following statements A and B and identify the correct answer:

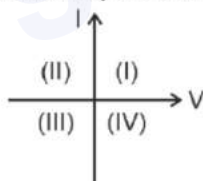

- A. For a solar-cell, the I-V characteristics lies in the IV quadrant of the given graph.
B. In a reverse biased *pn* junction diode, the current measured in (μA), is due to majority charge carriers.
- (1) Both A and B are incorrect
(2) A is correct but B is incorrect
(3) A is incorrect but B is correct
(4) Both A and B are correct

Answer (2)

Sol. A: Solar cell characteristics

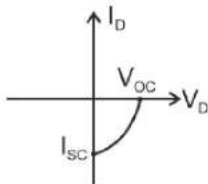

B: In reverse biased *pn* junction diode, the current measured in (μA), is due to minority charge carrier.

4. At any instant of time t , the displacement of any particle is given by $2t - 1$ (SI unit) under the influence of force of 5 N. The value of instantaneous power is (in SI unit):
- (1) 6 (2) 10
(3) 5 (4) 7

Answer (2)

Sol. $x = 2t - 1$

$$v = \frac{dx}{dt} = 2 \text{ m s}^{-1}$$

$$P = F \cdot v \\ = 2 \times 5 = 10 \text{ W}$$

5. A wire of length ' l ' and resistance 100Ω is divided into 10 equal parts. The first 5 parts are connected in series while the next 5 parts are connected in parallel. The two combinations are again connected in series. The resistance of this final combination is:
- (1) 60Ω (2) 26Ω
(3) 52Ω (4) 55Ω

Answer (3)

Sol.

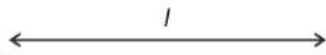

Divided into 10 parts

$$R = \frac{\rho l}{A}$$

$$R' = \frac{\rho l}{10A} = \frac{R}{10}$$

$$R_S = 5 \times \frac{R}{10} \quad [\text{series}]$$

$$R_S = 50$$

$$R_P = \frac{R}{50} \quad [\text{parallel}]$$

$$R_{eq} = R_S + R_P \\ = 52 \Omega$$

6. A thermodynamic system is taken through the cycle $abcd$. The work done by the gas along the path bc is:

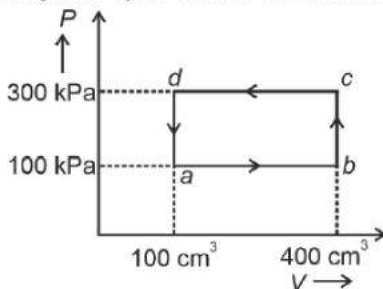

- (1) -60 J (2) Zero
(3) 30 J (4) -90 J

Answer (2)

Sol. Path bc is an isochoric process.

\therefore Work done by gas along path bc is zero.

7. A tightly wound 100 turns coil of radius 10 cm carries a current of 7 A. The magnitude of the magnetic field at the centre of the coil is (Take permeability of free space as $4\pi \times 10^{-7}$ SI units):
- (1) 44 T (2) 44 mT
(3) 4.4 T (4) 4.4 mT

Answer (4)

Sol. The magnitude of magnetic field due to circular coil of N turns is given by

$$B_C = \frac{\mu_0 i N}{2R}$$

$$= \frac{4\pi \times 10^{-7} \times 7 \times 100}{2 \times 0.1}$$

$$= 4.4 \times 10^{-3} \text{ T}$$

$$= 4.4 \text{ mT}$$

8. The terminal voltage of the battery, whose emf is 10 V and internal resistance 1 Ω , when connected through an external resistance of 4 Ω as shown in the figure is:

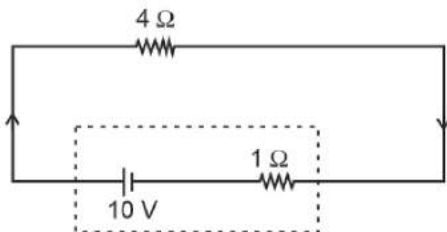

- (1) 10 V (2) 4 V
(3) 6 V (4) 8 V

Answer (4)

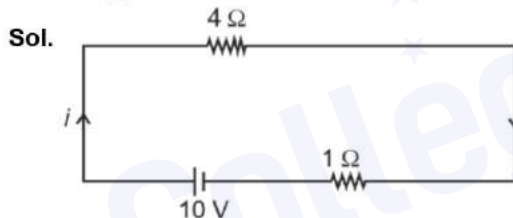

$$\text{Current in circuit } i = \frac{10}{4+1} = 2 \text{ A}$$

$$\text{Terminal voltage} = E - iR$$

$$= 10 - 2 \times 1 = 8 \text{ V}$$

9. A particle moving with uniform speed in a circular path maintains:
- (1) Varying velocity and varying acceleration (2) Constant velocity
(3) Constant acceleration (4) Constant velocity but varying acceleration

Answer (1)

Sol. A particle moving with uniform speed in a circular path maintains varying velocity and varying acceleration. It is because direction of both velocity as well as acceleration will change continuously.

10. A thin flat circular disc of radius 4.5 cm is placed gently over the surface of water. If surface tension of water is 0.07 N m^{-1} , then the excess force required to take it away from the surface is
- (1) 99 N (2) 19.8 mN
(3) 198 N (4) 1.98 mN

Answer (2)

Sol.

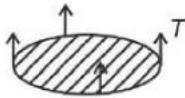

$$\text{Excess force} = T \times 2\pi R$$

$$= \frac{7}{100} \times 2 \times 3.14 \times \frac{4.5}{100}$$

$$= 197.82 \times 10^{-4}$$

$$= 19.8 \times 10^{-3} \text{ N}$$

$$= 19.8 \text{ mN}$$

11. The quantities which have the same dimensions as those of solid angle are:

- (1) angular speed and stress
- (2) strain and angle
- (3) stress and angle
- (4) strain and arc

Answer (2)

Sol. Solid angle $d\Omega = \frac{dA}{r^2}$ has dimensions $[M^0L^0T^0]$

Strain = $\frac{\Delta l}{l}$ has dimensions $[M^0L^0T^0]$

Angle measured in radians is also dimensionless $[M^0L^0T^0]$

$$\theta = \frac{l}{r}$$

12. A logic circuit provides the output Y as per the following truth table :

A	B	Y
0	0	1
0	1	0
1	0	1
1	1	0

The expression for the output Y is :

- (1) B
- (2) $A.B + \bar{A}$
- (3) $A.\bar{B} + \bar{A}$
- (4) \bar{B}

Answer (4)

Sol.

A	B	Y
0	0	1
0	1	0
1	0	1
1	1	0

According to given truth table, output is independent on value of A

$$\therefore \text{Output } Y = \bar{B}$$

13. A thin spherical shell is charged by some source. The potential difference between the two points C and P (in V) shown in the figure is:

(Take $\frac{1}{4\pi\epsilon_0} = 9 \times 10^9$ SI units)

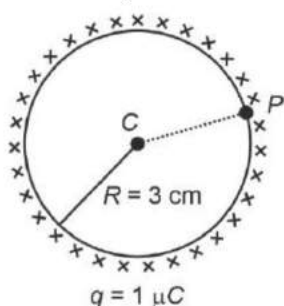

- (1) Zero (2) 3×10^5
(3) 1×10^5 (4) 0.5×10^5

Answer (1)

Sol. For uniformly charged spherical shell,

$$V = \frac{kq}{R} \quad (\text{For } r \leq R)$$

$$\therefore V_C = V_P$$

$$V_C - V_P = \text{Zero}$$

14. Match List I with List II.

	List I (Spectral Lines of Hydrogen for transitions from)		List II (Wavelengths (nm))
A.	$n_2 = 3$ to $n_1 = 2$	I.	410.2
B.	$n_2 = 4$ to $n_1 = 2$	II.	434.1
C.	$n_2 = 5$ to $n_1 = 2$	III.	656.3
D.	$n_2 = 6$ to $n_1 = 2$	IV.	486.1

Choose the correct answer from the options given below:

- (1) A-I, B-II, C-III, D-IV
(2) A-II, B-I, C-IV, D-III
(3) A-III, B-IV, C-II, D-I
(4) A-IV, B-III, C-I, D-II

Answer (3)

Sol. Energy difference $\Delta E = \frac{hc}{\lambda}$

$$\therefore \lambda \propto \frac{1}{\Delta E}$$

$$(\Delta E)_{6-2} > (\Delta E)_{5-2} > (\Delta E)_{4-2} > (\Delta E)_{3-2}$$

$$\lambda_{6-2} < \lambda_{5-2} < \lambda_{4-2} < \lambda_{3-2}$$

A-III, B-IV, C-II, D-I

15. Match List-I with List-II.

List-I (Material)	List-II (Susceptibility (χ))
A. Diamagnetic	I. $\chi = 0$
B. Ferromagnetic	II. $0 > \chi \geq -1$
C. Paramagnetic	III. $\chi \gg 1$
D. Non-magnetic	IV. $0 < \chi < \epsilon$ (a small positive number)

Choose the correct answer from the options given below

- | | |
|----------------------------|----------------------------|
| (1) A-IV, B-III, C-II, D-I | (2) A-II, B-III, C-IV, D-I |
| (3) A-II, B-I, C-III, D-IV | (4) A-III, B-II, C-I, D-IV |

Answer (2)

Sol.

(Material)	(Susceptibility (χ))
Diamagnetic	(II) $0 > \chi \geq -1$
Ferromagnetic	(III) $\chi \gg 1$
Paramagnetic	(IV) $0 < \chi < \epsilon$
Non-magnetic	(I) $\chi = 0$

16. Two bodies A and B of same mass undergo completely inelastic one dimensional collision. The body A moves with velocity v_1 while body B is at rest before collision. The velocity of the system after collision is v_2 . The ratio $v_1 : v_2$ is

- | | |
|-----------|-----------|
| (1) 1 : 4 | (2) 1 : 2 |
| (3) 2 : 1 | (4) 4 : 1 |

Answer (3)

Sol. Before collision $\Rightarrow \textcircled{A} \rightarrow v_1$ \textcircled{B}
rest

It undergoes completely inelastic collision

Using conservation of linear momentum

Initial momentum = Final momentum

$$\Rightarrow mv_1 = mv_2 + mv_2$$

$$\Rightarrow mv_1 = 2mv_2$$

$$\Rightarrow \frac{v_1}{v_2} = \frac{2}{1}$$

17. Given below are two statements:

Statement I: Atoms are electrically neutral as they contain equal number of positive and negative charges.

Statement II: Atoms of each element are stable and emit their characteristic spectrum.

In the light of the above statements, choose the *most appropriate* answer from the options given below.

- (1) Statement I is incorrect but Statement II is correct
- (2) Both Statement I and Statement II are correct
- (3) Both Statement I and Statement II are incorrect
- (4) Statement I is correct but Statement II is incorrect

Answer (4)

Sol. Statement I is true as atoms are electrically neutral because they contain equal number of positive and negative charges.

Statement II is wrong as atom of most of the elements are stable and emit characteristic spectrum. But this statement is not true for every atom.

18. If $x = 5 \sin\left(\pi t + \frac{\pi}{3}\right)$ m represents the motion of a particle executing simple harmonic motion, the amplitude and time period of motion, respectively, are

- (1) 5 m, 1 s (2) 5 cm, 2 s
(3) 5 m, 2 s (4) 5 cm, 1 s

Answer (3)

Sol. $x = 5 \sin\left(\pi t + \frac{\pi}{3}\right)$ m

Amplitude = 5 m

$$\omega = \pi = \frac{2\pi}{T}$$

$$T = \frac{2\pi}{\pi} = 2 \text{ s}$$

19. The output (Y) of the given logic gate is similar to the output of an/a

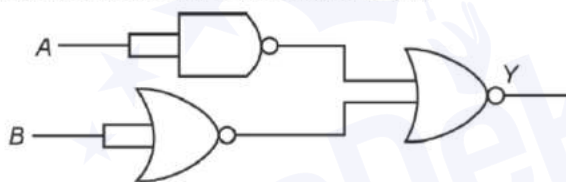

- (1) AND gate (2) NAND gate
(3) NOR gate (4) OR gate

Answer (1)

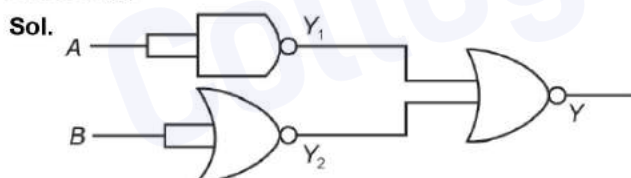

$$Y_1 = \overline{A \cdot A}$$

$$= \overline{A}$$

$$Y_2 = \overline{B + B}$$

$$= \overline{B}$$

$$Y = \overline{Y_1 + Y_2}$$

$$= \overline{\overline{A} + \overline{B}}$$

$$= \overline{\overline{A \cdot B}}$$

$$= A \cdot B$$

= A.B is similar to output of AND Gate

20. In a vernier callipers, $(N + 1)$ divisions of vernier scale coincide with N divisions of main scale. If 1 MSD represents 0.1 mm, the vernier constant (in cm) is:

- (1) $10(N + 1)$ (2) $\frac{1}{10N}$
 (3) $\frac{1}{100(N + 1)}$ (4) $100N$

Answer (3)

Sol. V.C = MSD – VSD ... (1)

given : $(N + 1)$ VSD = N MSD

$VSD = \left(\frac{N}{N + 1}\right) MSD$... (2)

From (1) and (2)

$V.C = (MSD) - \frac{N}{N + 1}(MSD)$

$= MSD \left(1 - \frac{N}{N + 1}\right) = \frac{MSD}{N + 1}$

$= \frac{0.01}{N + 1} = \frac{1}{100(N + 1)}$

21. A bob is whirled in a horizontal plane by means of a string with an initial speed of ω rpm. The tension in the string is T . If speed becomes 2ω while keeping the same radius, the tension in the string becomes:

- (1) $\sqrt{2}T$ (2) T
 (3) $4T$ (4) $\frac{T}{4}$

Answer (3)

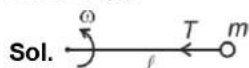

$T = m\ell\omega^2$



$T' = m\ell(2\omega)^2$

$T' = 4T$

22. If c is the velocity of light in free space, the correct statements about photon among the following are:

- A. The energy of a photon is $E = h\nu$.
 B. The velocity of a photon is c .
 C. The momentum of a photon, $p = \frac{h\nu}{c}$.
 D. In a photon-electron collision, both total energy and total momentum are conserved.
 E. Photon possesses positive charge.

Choose the correct answer from the options given below:

- (1) A, B, D and E only (2) A and B only
 (3) A, B, C and D only (4) A, C and D only

Answer (3)

Sol. The potential V at any point, at distance r from centre of dipole $= \frac{KP \cos \theta}{r^2}$

At axial point where $\theta = 0^\circ$, $V = \frac{KP}{r^2} = \frac{9 \times 10^9 \times 4 \times 10^{-6}}{2^2} = 9 \times 10^3 \text{ V}$

At axial point where $\theta = 180^\circ$, $V = \frac{-KP}{r^2} = -9 \times 10^3 \text{ V}$

25. The mass of a planet is $\frac{1}{10}$ th that of the earth and its diameter is half that of the earth. The acceleration due to gravity on that planet is:

- (1) 3.92 m s^{-2} (2) 19.6 m s^{-2}
(3) 9.8 m s^{-2} (4) 4.9 m s^{-2}

Answer (1)

Sol. $g' = \frac{GM'}{R'^2} = \frac{GM}{10\left(\frac{R}{2}\right)^2}$
 $= \frac{4}{10} \frac{GM}{R^2} = 0.4 \times 9.8$
 $= 3.92 \text{ m s}^{-2}$

26. In an ideal transformer, the turns ratio is $\frac{N_P}{N_S} = \frac{1}{2}$. The ratio $V_S : V_P$ is equal to (the symbols carry their usual meaning) :

- (1) 1 : 4 (2) 1 : 2
(3) 2 : 1 (4) 1 : 1

Answer (3)

Sol. According to transformer ratio,

$$\frac{V_S}{V_P} = \frac{N_S}{N_P} = 2 : 1$$

27. If the monochromatic source in Young's double slit experiment is replaced by white light, then

- (1) All bright fringes will be of equal width
(2) Interference pattern will disappear
(3) There will be a central dark fringe surrounded by a few coloured fringes
(4) There will be a central bright white fringe surrounded by a few coloured fringes

Answer (4)

Sol. At central point on screen, path difference is zero for all wavelength. So, central bright fringe is white and other fringes depend on wavelength as $\beta = \frac{\lambda D}{d}$.

Therefore, other fringes will be coloured.

28. The maximum elongation of a steel wire of 1 m length if the elastic limit of steel and its Young's modulus, respectively, are $8 \times 10^8 \text{ N m}^{-2}$ and $2 \times 10^{11} \text{ N m}^{-2}$, is:

- (1) 8 mm
(2) 4 mm
(3) 0.4 mm
(4) 40 mm

Answer (2)

Sol. In the case for maximum elongation,

Stress = Elastic limit

$$\delta_{\max} = \frac{\sigma_{\text{elastic}} \times L}{\text{Young's modulus}} = \frac{8 \times 10^8 \times 1}{2 \times 10^{11}} = 4 \times 10^{-3}$$

$$= 4 \text{ mm}$$

i.e. maximum elongation is 4 mm

29. An unpolarised light beam strikes a glass surface at Brewster's angle. Then
- (1) The reflected light will be completely polarised but the refracted light will be partially polarised.
 - (2) The reflected light will be partially polarised.
 - (3) The refracted light will be completely polarised.
 - (4) Both the reflected and refracted light will be completely polarised.

Answer (1)

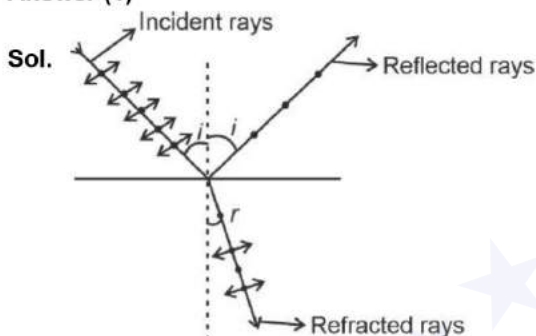

According to Brewster's law, reflected rays are completely polarized and refracted rays are partially polarized.

30. In a uniform magnetic field of 0.049 T, a magnetic needle performs 20 complete oscillations in 5 seconds as shown. The moment of inertia of the needle is $9.8 \times 10^{-6} \text{ kg m}^2$. If the magnitude of magnetic moment of the needle is $x \times 10^{-5} \text{ Am}^2$, then the value of 'x' is :

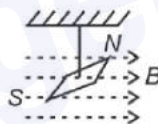

- (1) $1280\pi^2$
- (2) $5\pi^2$
- (3) $128\pi^2$
- (4) $50\pi^2$

Answer (1)

Sol. Time period of Oscillation, $T = 2\pi\sqrt{\frac{I}{MB}}$

$$\Rightarrow \frac{1}{4} = 2\pi\sqrt{\frac{9.8 \times 10^{-6}}{M \times 0.049}}$$

$$\Rightarrow \frac{1}{16} = 4\pi^2 \times \frac{9.8 \times 10^{-6}}{M \times 49 \times 10^{-3}}$$

$$\Rightarrow M = \frac{4\pi^2 \times 9.8 \times 10^{-6}}{49 \times 10^{-3}} \times 16$$

$$= \frac{4\pi^2 \times 9.8 \times 16 \times 10^{-3}}{49}$$

$$= 12.8\pi^2 \times 10^{-3} \times 10^{-2} \times 10^2$$

$$= 1280\pi^2 \times 10^{-5} \text{ Am}^2$$

31. A light ray enters through a right angled prism at point P with the angle of incidence 30° as shown in figure. It travels through the prism parallel to its base BC and emerges along the face AC . The refractive index of the prism is:

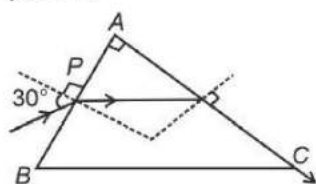

- (1) $\frac{\sqrt{3}}{2}$ (2) $\frac{\sqrt{5}}{4}$
 (3) $\frac{\sqrt{5}}{2}$ (4) $\frac{\sqrt{3}}{4}$

Answer (3)

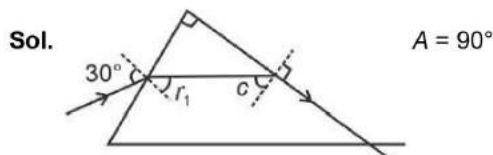

In prism, $r_1 + c = A$

$$r_1 = 90^\circ - c \quad \dots(1)$$

$$\sin c = \frac{1}{\mu} \Rightarrow \cos c = \frac{\sqrt{\mu^2 - 1}}{\mu}$$

\Rightarrow Apply Snell's law, on incidence surface

$$1 \cdot \sin 30^\circ = \mu \sin(r_1) \Rightarrow 1 \times \frac{1}{2} = \mu \times \sin(90^\circ - c)$$

$$\frac{1}{2} = \mu \times \frac{\sqrt{\mu^2 - 1}}{\mu}$$

On squaring $\frac{1}{4} = \mu^2 - 1$

$$\Rightarrow \mu^2 = \frac{5}{4} \Rightarrow \mu = \frac{\sqrt{5}}{2}$$

32. The moment of inertia of a thin rod about an axis passing through its mid point and perpendicular to the rod is 2400 g cm^2 . The length of the 400 g rod is nearly:

- (1) 72.0 cm (2) 8.5 cm
 (3) 17.5 cm (4) 20.7 cm

Answer (2)

Sol. Moment of inertia of rod $= I = \frac{m\ell^2}{12}$

$$\Rightarrow 2400 = 400 \frac{\ell^2}{12}$$

$$\Rightarrow 72 = \ell^2$$

$$\Rightarrow \ell = \sqrt{72} = 8.48 \text{ cm} \approx 8.5 \text{ cm}$$

33. In the following circuit, the equivalent capacitance between terminal A and terminal B is :

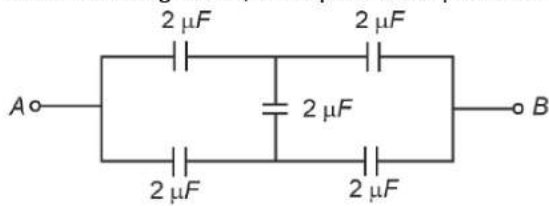

- (1) $4 \mu F$ (2) $2 \mu F$
(3) $1 \mu F$ (4) $0.5 \mu F$

Answer (2)

Sol.

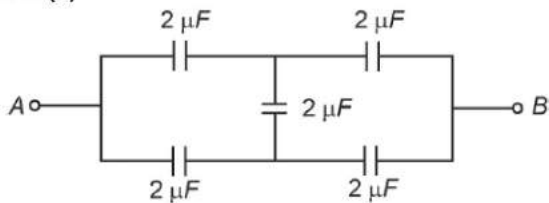

Given circuit is balanced Wheatstone bridge

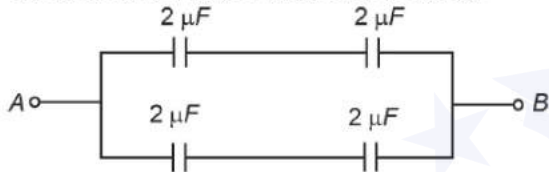

$$C_{AB} = 1 + 1$$

$$= 2 \mu F$$

34. A wheel of a bullock cart is rolling on a level road as shown in the figure below. If its linear speed is v in the direction shown, which one of the following options is correct (P and Q are any highest and lowest points on the wheel, respectively)?

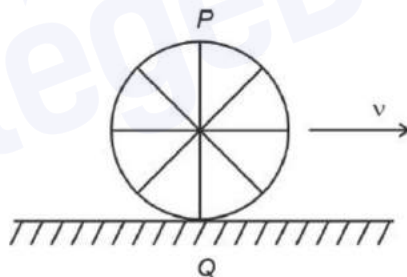

- (1) Point P has zero speed (2) Point P moves slower than point Q
(3) Point P moves faster than point Q (4) Both the points P and Q move with equal speed

Answer (3)

Sol. In the case of pure rolling,

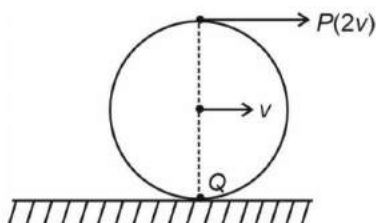

The topmost point will have velocity $2v$ while point Q i.e. lowest point will have zero velocity.
Hence point P moves faster than point Q .

35. The graph which shows the variation of $\left(\frac{1}{\lambda^2}\right)$ and its kinetic energy, E is (where λ is de Broglie wavelength of a free particle):

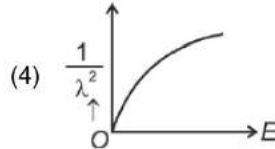
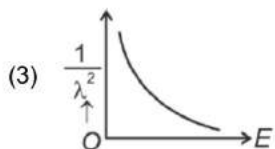
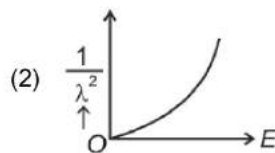
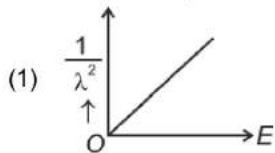

Answer (1)

Sol. de-Broglie wavelength $\lambda = \frac{h}{P} = \frac{h}{mv} = \frac{h}{\sqrt{2mE}}$ where $E = \frac{1}{2}mv^2$

Squaring both sides,

$$\lambda^2 = \frac{h^2}{4m^2E}$$

$$\Rightarrow \frac{1}{\lambda^2} = (\text{constant}) E$$

Graph passes through origin with constant slope.

SECTION-B

36. A small telescope has an objective of focal length 140 cm and an eye piece of focal length 5.0 cm. The magnifying power of telescope for viewing a distant object is:
- (1) 32 (2) 34
(3) 28 (4) 17

Answer (3)

Sol. $f_0 = 140$ cm and $f_e = 5$ cm

For distant object,

$$m = \frac{f_0}{f_e} = \frac{140}{5} = 28$$

37. The following graph represents the T - V curves of an ideal gas (where T is the temperature and V the volume) at three pressures P_1 , P_2 and P_3 compared with those of Charles's law represented as dotted lines.

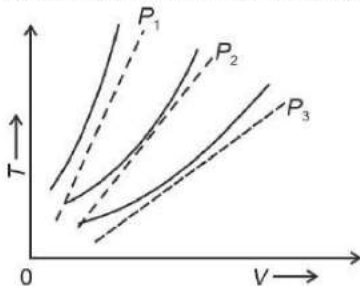

Then the correct relation is:

- (1) $P_1 > P_2 > P_3$ (2) $P_3 > P_2 > P_1$
(3) $P_1 > P_3 > P_2$ (4) $P_2 > P_1 > P_3$

Answer (1)

Sol. At same temperature, curve with higher volume corresponds to lower pressure.

$$V_3 > V_2 > V_1$$

$$\Rightarrow P_1 > P_2 > P_3$$

(We draw a straight line parallel to volume axis to get this)

38. If the mass of the bob in a simple pendulum is increased to thrice its original mass and its length is made half its original length, then the new time period of oscillation is $\frac{x}{2}$ times its original time period. Then the value of x is:

- (1) 4 (2) $\sqrt{3}$
 (3) $\sqrt{2}$ (4) $2\sqrt{3}$

Answer (3)

Sol. $T' = 2\pi\sqrt{\frac{\ell'}{g}}$ where $\ell' = \frac{\ell}{2}$

$$T = 2\pi\sqrt{\frac{\ell}{g}}$$

$$T' = \frac{x}{2}T$$

$$2\pi\sqrt{\frac{\ell}{2g}} = \frac{x}{2}2\pi\sqrt{\frac{\ell}{g}}$$

$$\frac{1}{\sqrt{2}} = \frac{x}{2} \Rightarrow x = \sqrt{2}$$

39. Two heaters A and B have power rating of 1 kW and 2 kW, respectively. Those two are first connected in series and then in parallel to a fixed power source. The ratio of power outputs for these two cases is:

- (1) 2 : 3
 (2) 1 : 1
 (3) 2 : 9
 (4) 1 : 2

Answer (3)

Sol. Power Consumed = $P = \frac{V^2}{R}$

$$\frac{P_A}{P_B} = \frac{R_B}{R_A}$$

$$R_A = 2R_B$$

For Series Combination

$$P_S = \frac{V^2}{3R_B}$$

For Parallel Combination

$$P_P = \frac{3V^2}{2R_B}$$

$$\frac{P_S}{P_P} = \frac{2}{9}$$

40. A force defined by $F = \alpha t^2 + \beta t$ acts on a particle at a given time t . The factor which is dimensionless, if α and β are constants, is:

- (1) $\frac{\alpha\beta}{t}$ (2) $\frac{\beta t}{\alpha}$
 (3) $\frac{\alpha t}{\beta}$ (4) $\alpha\beta t$

Answer (3)

Sol. From principle of homogeneity

$$[F] = [\alpha t^2] = [\beta t]$$

$$[\alpha] = \frac{[F]}{[t^2]} \text{ and } [\beta] = \frac{[F]}{[t]}$$

$$\therefore [\alpha] [t] = [\beta]$$

$$\therefore \frac{\alpha t}{\beta} = \text{dimensionless}$$

41. If the plates of a parallel plate capacitor connected to a battery are moved close to each other, then
- the charge stored in it, increases.
 - the energy stored in it, decreases.
 - its capacitance increases.
 - the ratio of charge to its potential remains the same.
 - the product of charge and voltage increases.

Choose the most appropriate answer from the options given below:

- (1) A, B and C only (2) A, B and E only
 (3) A, C and E only (4) B, D and E only

Answer (3)

Sol. Given $V' = V = \text{Constant}$

$$(i) C' = \frac{\epsilon_0 A}{d'}, C = \frac{\epsilon_0 A}{d}$$

$$d' < d$$

$$C' > C$$

Hence, final capacitance greater than initial capacitance,

$$(ii) U' = \frac{1}{2} C' V^2$$

$$U = \frac{1}{2} C V^2$$

$$U' > U$$

Hence final energy is greater than initial energy

$$(iii) \frac{Q'}{V'} = C' \text{ and } \frac{Q}{V} = C$$

$$\frac{Q'}{V'} \neq \frac{Q}{V}$$

(iv) Product of charge and voltage

$$X' = Q' V = C' V^2$$

$$X = Q V = C V^2$$

$$X' > X$$

42. An iron bar of length L has magnetic moment M . It is bent at the middle of its length such that the two arms make an angle 60° with each other. The magnetic moment of this new magnet is :

- (1) $\frac{M}{\sqrt{3}}$ (2) M
 (3) $\frac{M}{2}$ (4) $2M$

Answer (3)

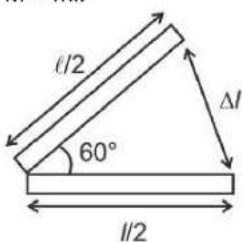
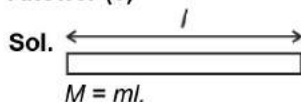

$$\Delta l = 2 \frac{l}{2} \sin 30^\circ$$

$$= \frac{l}{2}$$

$$M' = m \frac{l}{2} = \frac{M}{2}$$

43. A sheet is placed on a horizontal surface in front of a strong magnetic pole. A force is needed to:
- hold the sheet there if it is magnetic.
 - hold the sheet there if it is non-magnetic.
 - move the sheet away from the pole with uniform velocity if it is conducting.
 - move the sheet away from the pole with uniform velocity if it is both, non-conducting and non-polar.

Choose the correct statement(s) from the options given below:

- (1) C only (2) B and D only
 (3) A and C only (4) A, C and D only

Answer (3)

Sol.

- A magnetic pole will repel or attract magnetic sheet so force is need.
- If sheet is non-magnetic, no force needed.
- If it is conducting, then there will be eddy current in sheet, which opposes the motion. So forces is needed move sheet with uniform speed.
- The non-conducting and non-polar sheet do not interact with magnetic field of magnet.

44. A $10 \mu\text{F}$ capacitor is connected to a 210 V , 50 Hz source as shown in figure. The peak current in the circuit is nearly ($\pi = 3.14$):

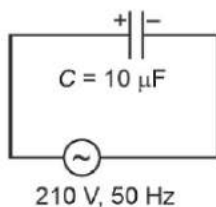

- (1) 0.35 A (2) 0.58 A
 (3) 0.93 A (4) 1.20 A

Answer (3)

Sol. Capacitive Reactance $X_C = \frac{1}{\omega C} = \frac{1}{2\pi fC} = \frac{1}{2 \times 3.14 \times 50 \times 10 \times 10^{-6}}$
 $= \frac{1000}{3.14}$

$V_{rms} = 210 \text{ V}$

$i_{rms} = \frac{V_{rms}}{X_C} = \frac{210}{X_C}$

Peak current $= \sqrt{2}i_{rms} = \sqrt{2} \times \frac{210}{1000} \times 3.14 = 0.932$
 $\approx 0.93 \text{ A}$

45. A metallic bar of Young's modulus, $0.5 \times 10^{11} \text{ N m}^{-2}$ and coefficient of linear thermal expansion $10^{-5} \text{ }^\circ\text{C}^{-1}$, length 1 m and area of cross-section 10^{-3} m^2 is heated from 0°C to 100°C without expansion or bending. The compressive force developed in it is :

- (1) $2 \times 10^3 \text{ N}$ (2) $5 \times 10^3 \text{ N}$
 (3) $50 \times 10^3 \text{ N}$ (4) $100 \times 10^3 \text{ N}$

Answer (3)

Sol. Thermal strain = Longitudinal strain $= \alpha \Delta T$

\Rightarrow Longitudinal strain, $\delta = 10^{-5} \times 10^2 = 10^{-3}$

\Rightarrow Compressive stress $= \delta \times \text{Young's Modulus}$

$= 10^{-3} \times 0.5 \times 10^{11}$

$= 0.5 \times 10^8$

\Rightarrow Compressive force $= 0.5 \times 10^8 \times 10^{-3} = 0.5 \times 10^5$

$= 5 \times 10^4 \times \frac{10}{10}$

$= 50 \times 10^3 \text{ N}$

46. The velocity (v) – time (t) plot of the motion of a body is shown below:

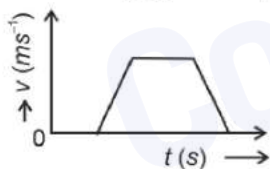

The acceleration (a) – time (t) graph that best suits this motion is :

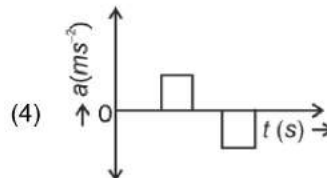
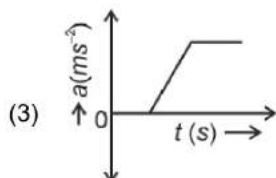
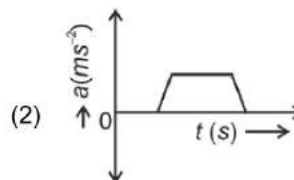
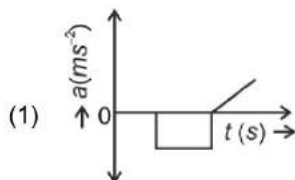

Answer (4)

Sol. Initially, the body has zero velocity and zero slope. Hence the acceleration would be zero initially. After that, the slope of v-t curve is constant and positive.

After some time, velocity becomes constant and acceleration is zero.

After that, the slope of v-t curve is constant and negative.

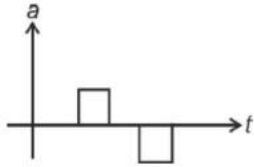

47. Choose the correct circuit which can achieve the bridge balance.

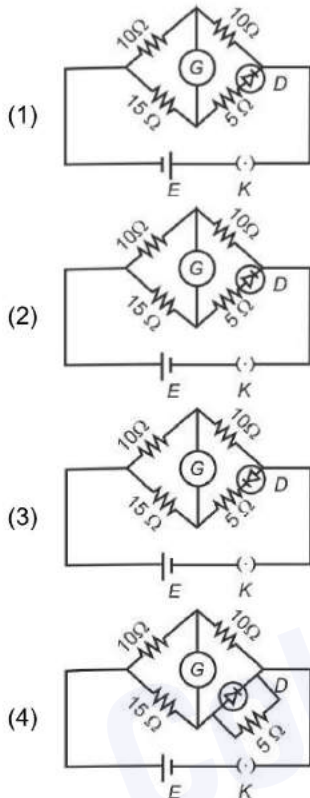

Answer (2)

Sol. In option (2),

$$\frac{10}{15} = \frac{10}{5 + R_D}$$

The diode can conduct and have resistance $R_D = 10 \Omega$ because diode have dynamic resistance. In that case bridge will be balanced.

48. The property which is not of an electromagnetic wave travelling in free space is that:

- (1) They originate from charges moving with uniform speed
- (2) They are transverse in nature
- (3) The energy density in electric field is equal to energy density in magnetic field
- (4) They travel with a speed equal to $\frac{1}{\sqrt{\mu_0 \epsilon_0}}$

Answer (1)

Sol. The EM waves originate from an accelerating charge. The charge moving with uniform velocity produces steady state magnetic field.

49. The minimum energy required to launch a satellite of mass m from the surface of earth of mass M and radius R in a circular orbit at an altitude of $2R$ from the surface of the earth is:

(1) $\frac{GmM}{3R}$

(2) $\frac{5GmM}{6R}$

(3) $\frac{2GmM}{3R}$

(4) $\frac{GmM}{2R}$

Answer (2)

Sol. Apply energy conservation,

$$U_i + K_i = U_f + K_f$$

$$\Rightarrow -\frac{GMm}{R} + K_i = -\frac{GMm}{3R} + \frac{1}{2}mv^2$$

$$\Rightarrow -\frac{GMm}{R} + K_i = -\frac{GMm}{3R} + \frac{1}{2} \times m \times \frac{GM}{3R}$$

$$\Rightarrow K_i = -\frac{1}{6} \frac{GMm}{R} + \frac{GMm}{R}$$

$$K_i = \frac{5}{6} \frac{GMm}{R}$$

50. A parallel plate capacitor is charged by connecting it to a battery through a resistor. If I is the current in the circuit, then in the gap between the plates:

- (1) Displacement current of magnitude greater than I flows but can be in any direction
- (2) There is no current
- (3) Displacement current of magnitude equal to I flows in the same direction as I
- (4) Displacement current of magnitude equal to I flows in a direction opposite to that of I

Answer (3)

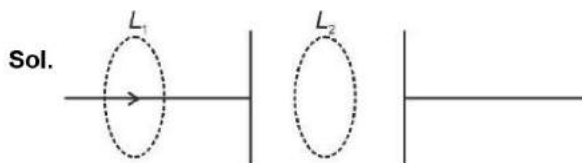

According to modified Ampere's law

$$\oint \mathbf{B} \cdot d\mathbf{l} = \mu_0 (I_C + I_D)$$

For Loop L_1 $I_C \neq 0$ and $I_D = 0$

For Loop L_2 $I_C = 0$ and $I_D \neq 0$

Due to KCL $I_C = I_D$

CHEMISTRY

SECTION-A

51. Match List I with List II.

List I

(Conversion)

- A. 1 mol of H₂O to O₂
 B. 1 mol of MnO₄⁻ to Mn²⁺
 C. 1.5 mol of Ca from molten CaCl₂
 D. 1 mol of FeO to Fe₂O₃

List II

(Number of Faraday required)

- I. 3F
 II. 2F
 III. 1F
 IV. 5F

Choose the correct answer from the options given below:

- (1) A-III, B-IV, C-II, D-I
 (2) A-II, B-IV, C-I, D-III
 (3) A-III, B-IV, C-I, D-II
 (4) A-II, B-III, C-I, D-IV

Answer (2)

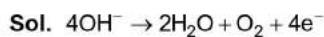

for 2 mole of H₂O = 4F charge is required

for 1 mole of H₂O = $\frac{4F}{2} = 2F$ required

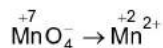

for 1 mole MnO₄⁻ 5F charge is required

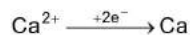

For 1 mole Ca²⁺ ion required = 2F

1.5 mole Ca²⁺ ion required = $\frac{2}{1} \times 1.5 = 3F$



for 1 mole FeO, 1F charge is required.

52. The highest number of helium atoms is in

- (1) 2.271098 L of helium at STP
 (2) 4 mol of helium
 (3) 4 u of helium
 (4) 4 g of helium

Answer (2)

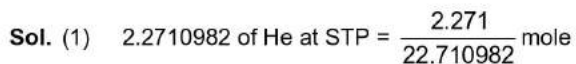

$$= 0.1 \text{ mole}$$

$$= 0.1 N_A \text{ He atom}$$

(2) 4 mol of He = 4 N_A He atoms

(3) 4 u of He = $\frac{4 \text{ u}}{4 \text{ u}} = 1 \text{ He atom}$

(4) 4 g of Helium = $\frac{4 \text{ g}}{4 \text{ g}} \text{ mole} = 1 \text{ mole} = N_A \text{ He atom}$

53. Which plot of $\ln k$ vs $\frac{1}{T}$ is consistent with Arrhenius equation?

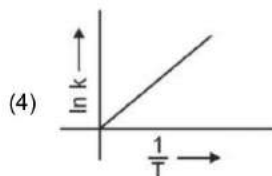
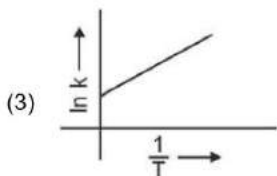
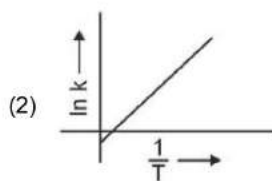
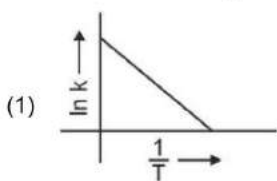

Answer (1)

Sol. The Arrhenius equation is given as

$$k = Ae^{-\frac{E_a}{RT}}$$

$$\therefore \ln k = \ln A - \frac{E_a}{RT}$$

$\ln k$ vs $\frac{1}{T}$ gives a straight line graph with slope = $-\frac{E_a}{R}$ and intercept = $\ln A$

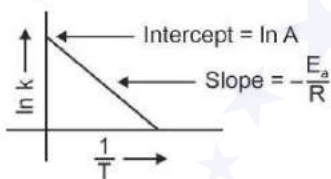

54. For the reaction $2A \rightleftharpoons B + C$, $K_c = 4 \times 10^{-3}$. At a given time, the composition of reaction mixture is: $[A] = [B] = [C] = 2 \times 10^{-3}$ M.

Then, which of the following is correct?

- (1) Reaction has gone to completion in forward direction.
- (2) Reaction is at equilibrium.
- (3) Reaction has a tendency to go in forward direction.
- (4) Reaction has a tendency to go in backward direction.

Answer (4)

Sol. $2A \rightleftharpoons B + C$, $K_c = 4 \times 10^{-3}$

At a given time t , Q_c is to be calculated and been compared with K_c .

$$Q_c = \frac{[B][C]}{[A]^2} = \frac{(2 \times 10^{-3})(2 \times 10^{-3})}{(2 \times 10^{-3})^2}$$

$$Q_c = 1$$

As $Q_c > K_c$, so reaction has a tendency to move backward.

55. Match List I with List II.

List I (Complex)

- A. $[\text{Co}(\text{NH}_3)_5(\text{NO}_2)]\text{Cl}_2$
- B. $[\text{Co}(\text{NH}_3)_5(\text{SO}_4)]\text{Br}$
- C. $[\text{Co}(\text{NH}_3)_6][\text{Cr}(\text{CN})_6]$
- D. $[\text{Co}(\text{H}_2\text{O})_6]\text{Cl}_3$

List II (Type of isomerism)

- I. Solvate isomerism
- II. Linkage isomerism
- III. Ionization isomerism
- IV. Coordination isomerism

Choose the correct answer from the options given below:

- (1) A-II, B-IV, C-III, D-I
(2) A-II, B-III, C-IV, D-I
(3) A-I, B-III, C-IV, D-II
(4) A-I, B-IV, C-III, D-II

Answer (2)

- Sol.** A. $[\text{Co}(\text{NH}_3)_5(\text{NO}_2)]\text{Cl}_2$ II. Linkage isomerism due to 'N' and 'O' linkage by NO_2
B. $[\text{Co}(\text{NH}_3)_5(\text{SO}_4)]\text{Br}$ III. Ionization isomerism
C. $[\text{Co}(\text{NH}_3)_6][\text{Cr}(\text{CN})_6]$ IV. Coordination isomerism
D. $[\text{Co}(\text{H}_2\text{O})_6]\text{Cl}_3$ I. Solvate isomerism

56. A compound with a molecular formula of C_6H_{14} has two tertiary carbons. Its IUPAC name is :

- (1) 2,2-dimethylbutane (2) n-hexane
(3) 2-methylpentane (4) 2,3-dimethylbutane

Answer (4)

Sol. $\text{CH}_3 - \text{CH}_2 - \text{CH}_2 - \text{CH}_2 - \text{CH}_2 - \text{CH}_3$ has no tertiary carbon

(n-Hexane)

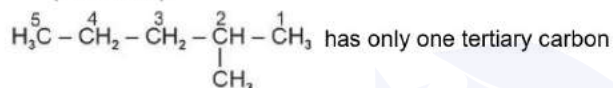

(2-Methylpentane)

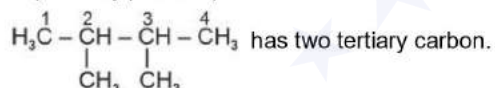

(2, 3-Dimethylbutane)

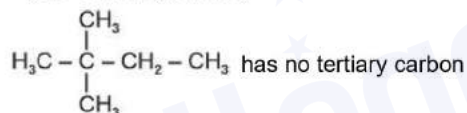

(2, 2-Dimethylbutane)

57. Match List I with List II

List I

(Quantum Number)

- A. m_l
B. m_s
C. l
D. n

List II

(Information provided)

- I. Shape of orbital
II. Size of orbital
III. Orientation of orbital
IV. Orientation of spin of electron

Choose the correct answer from the options given below :

- (1) A-II, B-I, C-IV, D-III (2) A-I, B-III, C-II, D-IV
(3) A-III, B-IV, C-I, D-II (4) A-III, B-IV, C-II, D-I

Answer (3)

- Sol.**
- Magnetic quantum number m_l informs about orientation of orbital.
 - Spin quantum number m_s informs about orientation of spin of electron.
 - Azimuthal quantum number (l) informs about shape of orbital
 - Principal quantum number (n) informs about size of orbital

58. 'Spin only' magnetic moment is same for which of the following ions?

- | | |
|--------------|--------------|
| A. Ti^{3+} | B. Cr^{2+} |
| C. Mn^{2+} | D. Fe^{2+} |
| E. Sc^{3+} | |

Choose the most appropriate answer from the options given below.

- | | |
|------------------|------------------|
| (1) A and D only | (2) B and D only |
| (3) A and E only | (4) B and C only |

Answer (2)

Sol.

Ions	No. of unpaired electrons	Configuration
Ti^{3+}	1	$3d^1$
Cr^{2+}	4	$3d^4$
Mn^{2+}	5	$3d^5$
Fe^{2+}	4	$3d^6$
Sc^{3+}	0	$3d^0$

Spin only magnetic moment is given by $\sqrt{n(n+2)}BM$

$\therefore Cr^{2+}$ and Fe^{2+} will have same spin only magnetic moment.

59. Which one of the following alcohols reacts instantaneously with Lucas reagent?

- | | |
|--|-----------------------------------|
| (1) $\begin{array}{c} CH_3 \\ \\ CH_3 - C - OH \\ \\ CH_3 \end{array}$ | (2) $CH_3 - CH_2 - CH_2 - CH_2OH$ |
| (3) $\begin{array}{c} CH_3 - CH_2 - CH - OH \\ \\ CH_3 \end{array}$ | (4) |

Answer (1)

Sol. Tertiary alcohols react instantaneously with Lucas reagent and gives immediate turbidity.

In case of tertiary alcohols, they form halides easily with Lucas reagent (conc. HCl and $ZnCl_2$)

60. Arrange the following elements in increasing order of electronegativity:

N, O, F, C, Si

Choose the correct answer from the options given below:

- | | |
|--------------------------|--------------------------|
| (1) $F < O < N < C < Si$ | (2) $Si < C < N < O < F$ |
| (3) $Si < C < O < N < F$ | (4) $O < F < N < C < Si$ |

Answer (2)

Sol. Electronegativity increases across the period on moving left to right. It decreases on moving down the group.

The correct option is $Si < C < N < O < F$

61. In which of the following processes entropy increases?

- A liquid evaporates to vapour.
- Temperature of a crystalline solid lowered from 130 K to 0 K.
- $2NaHCO_{3(s)} \rightarrow Na_2CO_{3(s)} + CO_{2(g)} + H_2O_{(g)}$
- $Cl_{2(g)} \rightarrow 2Cl_{(g)}$

Choose the correct answer from the options given below:

- (1) C and D (2) A and C
(3) A, B and D (4) A, C and D

Answer (4)

Sol. When a liquid evaporates to vapour entropy increases.

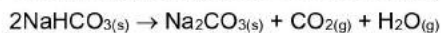

Number of gaseous product molecules increases so entropy increases.

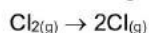

1 mole $\text{Cl}_{2(g)}$ form 2 mol $\text{Cl}_{(g)}$. So entropy increases.

62. The most stable carbocation among the following is :

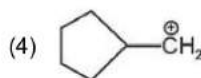
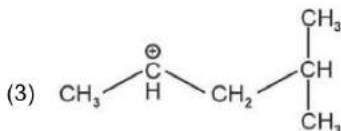
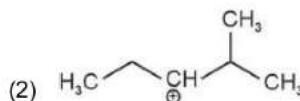
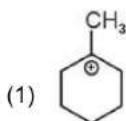

Answer (1)

Sol. The stability of carbocation can be described by the hyperconjugation. Greater the extent of hyperconjugation, more is the stability of carbocation.

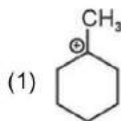

→ 7 α -H

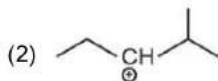

→ 3 α -H

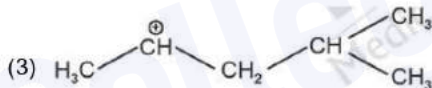

→ 5 α -H



→ 1 α -H

Stability order of carbocations = (1) > (3) > (2) > (4)

63. The energy of an electron in the ground state ($n = 1$) for He^+ ion is $-x$ J, then that for an electron in $n = 2$ state for Be^{3+} ion in J is

(1) $-\frac{4}{9}x$

(2) $-x$

(3) $-\frac{x}{9}$

(4) $-4x$

Answer (2)

Sol. $E_n = -R_H \left(\frac{Z^2}{n^2} \right) J$

For He^+ ($n = 1$),

$$E_n = -x = -R_H \left(\frac{2^2}{1^2} \right) = -4R_H$$

$$\therefore R_H = \frac{x}{4}$$

For Be^{3+} ($n = 2$),

$$E_n = -R_H \left(\frac{Z^2}{n^2} \right) \text{ J}$$

$$= -\frac{x}{4} \times \left(\frac{4 \times 4}{2 \times 2} \right) = -x \text{ J}$$

64. Given below are two statements:

Statement I : The boiling point of three isomeric pentanes follows the order

n-pentane > isopentane > neopentane

Statement II : When branching increases, the molecule attains a shape of sphere. This results in smaller surface area for contact, due to which the intermolecular forces between the spherical molecules are weak, thereby lowering the boiling point.

In the light of the above statements, choose the *most appropriate* answer from the options given below:

- (1) Statement I is incorrect but Statement II is correct
- (2) Both Statement I and Statement II are correct
- (3) Both Statement I and Statement II are incorrect
- (4) Statement I is correct but Statement II is incorrect

Answer (2)

Sol. Both statement I and statement II are correct.

Boiling point of n-pentane = 309 K

isopentane = 301 K

neopentane = 282.5

As branching increases molecules attain the shape of a sphere results in smaller area of contact thus weak intermolecular forces between spherical molecules, which are overcome at relatively lower temperature. Leading to decrease in boiling point.

65. Match List I with List II.

List I (Compound)	List II (Shape/geometry)
A. NH_3	I. Trigonal Pyramidal
B. BrF_5	II. Square Planar
C. XeF_4	III. Octahedral
D. SF_6	IV. Square Pyramidal

Choose the correct answer from the options given below:

- (1) A-II, B-III, C-IV, D-I
- (2) A-I, B-IV, C-II, D-III
- (3) A-II, B-IV, C-III, D-I
- (4) A-III, B-IV, C-I, D-II

Answer (2)

Sol. $\text{NH}_3 \Rightarrow sp^3$ hybridised with 1 lone pair.

Structure will be Trigonal Pyramidal.

$\text{BrF}_5 \Rightarrow sp^3d^2$ hybridised with 1 lone pair.

Structure will be Square Pyramidal.

$\text{XeF}_4 \Rightarrow sp^3d^2$ with two lone pairs.
Structure will be Square Planar.

$\text{SF}_6 \Rightarrow sp^3d^2$ with no lone pair.
Structure will be Octahedral.

A-I, B-IV, C-II, D-III

66. Given below are two statements:

Statement I: The boiling point of hydrides of Group 16 elements follow the order

$\text{H}_2\text{O} > \text{H}_2\text{Te} > \text{H}_2\text{Se} > \text{H}_2\text{S}$.

Statement II: On the basis of molecular mass, H_2O is expected to have lower boiling point than the other members of the group but due to the presence of extensive H-bonding in H_2O , it has higher boiling point.

In the light of the above statements, choose the correct answer from the options given below:

- (1) Statement I is false but Statement II is true (2) Both Statement I and Statement II are true
(3) Both Statement I and Statement II are false (4) Statement I is true but Statement II is false

Answer (2)

Sol. **Statement I** is correct, because boiling point of hydrides of group 16 follows the order

$\text{H}_2\text{O} > \text{H}_2\text{Te} > \text{H}_2\text{Se} > \text{H}_2\text{S}$.

Statement II due to intermolecular H-bonding H_2O shows higher boiling point than respective hydrides of group 16.

(Both Statement are true)

Order from H_2Te to H_2S is due to decreasing molar mass.

67. Arrange the following elements in increasing order of first ionization enthalpy:

Li, Be, B, C, N

Choose the correct answer from the options given below:

- (1) $\text{Li} < \text{Be} < \text{N} < \text{B} < \text{C}$ (2) $\text{Li} < \text{Be} < \text{B} < \text{C} < \text{N}$
(3) $\text{Li} < \text{B} < \text{Be} < \text{C} < \text{N}$ (4) $\text{Li} < \text{Be} < \text{C} < \text{B} < \text{N}$

Answer (3)

Sol. Increasing order of first ionization enthalpy is $\text{Li} < \text{B} < \text{Be} < \text{C} < \text{N}$

Element	First ionization enthalpy ($\Delta_i H / \text{kJ mol}^{-1}$)
Li	520
Be	899
B	801
C	1086
N	1402

68. Identify the correct reagents that would bring about the following transformation.

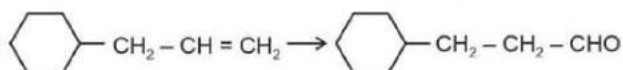

- (1) (i) $\text{H}_2\text{O}/\text{H}^+$
(ii) PCC
(2) (i) $\text{H}_2\text{O}/\text{H}^+$
(ii) CrO_3

- (3) (i) BH_3
 (ii) $\text{H}_2\text{O}_2 / \text{OH}^\ominus$
 (iii) PCC
- (4) (i) BH_3
 (ii) $\text{H}_2\text{O}_2 / \text{OH}^\ominus$
 (iii) alk. KMnO_4
 (iv) $\text{H}_3\text{O}^\oplus$

Answer (3)

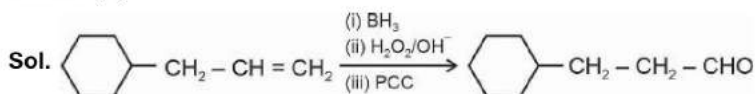

Mechanism :

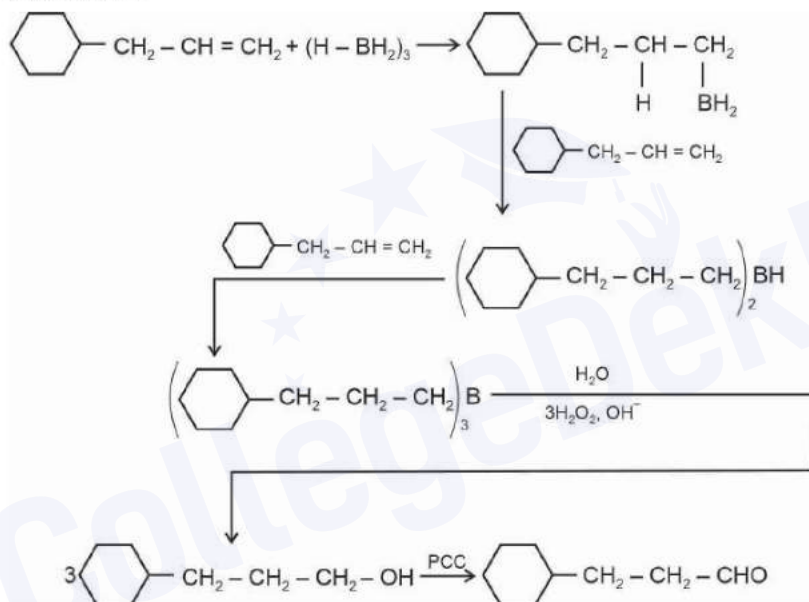

69. Activation energy of any chemical reaction can be calculated if one knows the value of

- (1) rate constant at two different temperatures
- (2) rate constant at standard temperature
- (3) probability of collision
- (4) orientation of reactant molecules during collision

Answer (1)

Sol. To calculate value of E_a

Equation used is

$$\log \left(\frac{k_2}{k_1} \right) = \frac{E_a}{2.303R} \left(\frac{1}{T_1} - \frac{1}{T_2} \right)$$

Hence E_a can be calculated if value of rate constant k is known at two different temperatures T_1 and T_2 .

70. On heating, some solid substances change from solid to vapour state without passing through liquid state. The technique used for the purification of such solid substances based on the above principle is known as

- (1) Chromatography (2) Crystallization
 (3) Sublimation (4) Distillation

Answer (3)

- Sol.** (1) **Chromatography** : It is based on separation by using stationary and mobile phase.
 (2) **Crystallization** : It is based on difference in the solubilities of the compound and impurities in a suitable solvent.
 (3) **Sublimation** : It is the purification technique based on principle that on heating, some solid substances change from solid to vapour state without passing through liquid state.
 (4) **Distillation** : It is used to separate volatile liquids from non-volatile impurities and the liquids having sufficient difference in their boiling point.

71. Among Group 16 elements, which one does **NOT** show -2 oxidation state?

- (1) Po (2) O
 (3) Se (4) Te

Answer (1)

- Sol.** Oxygen shows $-2, -1, +1$ and $+2$ oxidation states
 Selenium shows $-2, +2, +4$ and $+6$ oxidation states
 Tellurium shows $-2, +2, +4$ and $+6$ oxidation states
 Polonium shows $+2$ and $+4$ oxidation states

72. Match List I with List II.

List-I (Process)	List-II (Conditions)
A. Isothermal process	I. No heat exchange
B. Isochoric process	II. Carried out at constant temperature
C. Isobaric process	III. Carried out at constant volume
D. Adiabatic process	IV. Carried out at constant pressure

Choose the correct answer from the options given below:

- (1) A-II, B-III, C-IV, D-I (2) A-IV, B-III, C-II, D-I
 (3) A-IV, B-II, C-III, D-I (4) A-I, B-II, C-III, D-IV

Answer (1)

- Sol.** (A) Isothermal process \Rightarrow Temperature is constant throughout the process
 (B) Isochoric process \Rightarrow Volume is constant throughout the process
 (C) Isobaric process \Rightarrow Pressure is constant throughout the process
 (D) Adiabatic process \Rightarrow No exchange of heat (q) between system and surrounding

73. Which reaction is **NOT** a redox reaction?

- (1) $\text{BaCl}_2 + \text{Na}_2\text{SO}_4 \rightarrow \text{BaSO}_4 + 2\text{NaCl}$ (2) $\text{Zn} + \text{CuSO}_4 \rightarrow \text{ZnSO}_4 + \text{Cu}$
 (3) $2\text{KClO}_3 + \text{I}_2 \rightarrow 2\text{KIO}_3 + \text{Cl}_2$ (4) $\text{H}_2 + \text{Cl}_2 \rightarrow 2\text{HCl}$

Answer (1)

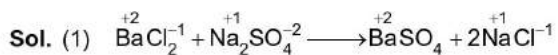

This is not a redox reaction as there is no change in oxidation state.

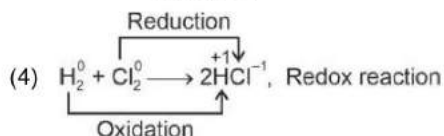
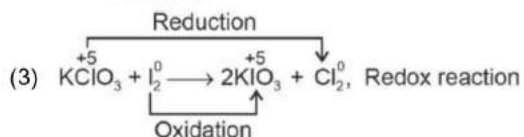
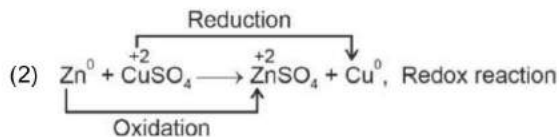

74. The Henry's law constant (K_H) values of three gases (A, B, C) in water are 145, 2×10^{-5} and 35 kbar, respectively. The solubility of these gases in water follow the order:

- (1) $A > B > C$ (2) $B > A > C$
(3) $B > C > A$ (4) $A > C > B$

Answer (3)

Sol. Value of Henry's law constant $\propto \frac{1}{\text{Solubility of gas}}$

Higher the value of K_H at a given pressure, lower is the solubility of the gas in the liquid.

K_H value of gases (given) : $A > C > B$

\therefore Order of solubility of gases in water : $B > C > A$

75. Match List I with List II.

List I

(Reaction)

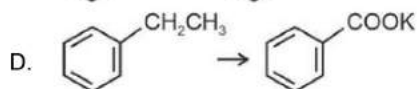
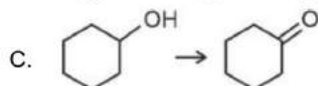
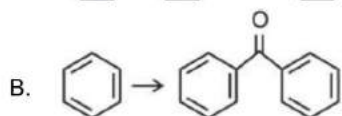
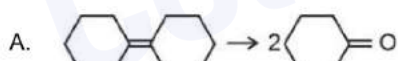

List II

(Reagents/Condition)

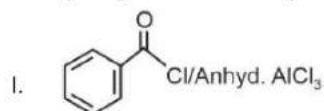

II. CrO_3

III. $\text{KMnO}_4/\text{KOH}, \Delta$

IV. (i) O_3

(ii) $\text{Zn-H}_2\text{O}$

Choose the correct answer from the options given below:

- (1) A-I, B-IV, C-II, D-III (2) A-IV, B-I, C-III, D-II
(3) A-III, B-I, C-II, D-IV (4) A-IV, B-I, C-II, D-III

Answer (4)

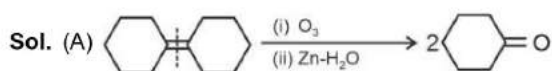

It is reductive ozonolysis

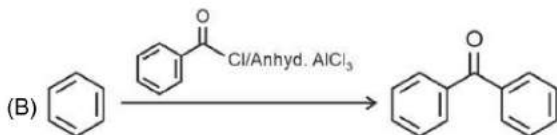

It is Friedel-Crafts acylation reaction.

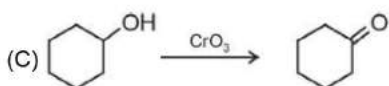

Secondary alcohols are oxidised to ketones by CrO_3

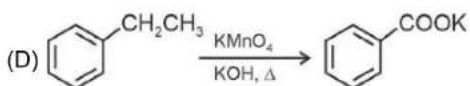

76. In which of the following equilibria, K_p and K_c are **NOT** equal?

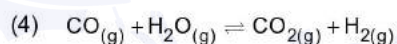
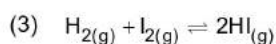
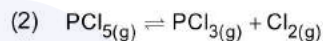
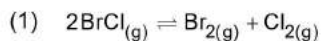

Answer (2)

Sol. $K_p = K_c (\text{RT})^{\Delta n_g}$

for $K_p \neq K_c$,

$\Delta n_g \neq 0$

$\Delta n_g = n_p - n_r$

(1) $\Delta n_g = 2 - 2 = 0$

(2) $\Delta n_g = 2 - 1 = 1$

(3) $\Delta n_g = 2 - 2 = 0$

(4) $\Delta n_g = 2 - 2 = 0$

77. Intramolecular hydrogen bonding is present in

(1) HF

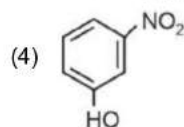
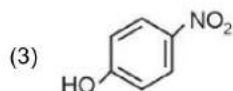
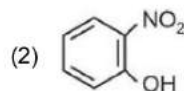

Answer (2)

Sol. In o-nitrophenol intramolecular H-bonding is present.

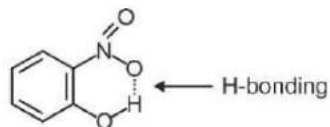

78. Given below are two statements :

Statement I: Both $[\text{Co}(\text{NH}_3)_6]^{3+}$ and $[\text{CoF}_6]^{3-}$ complexes are octahedral but differ in their magnetic behaviour.

Statement II: $[\text{Co}(\text{NH}_3)_6]^{3+}$ is diamagnetic whereas $[\text{CoF}_6]^{3-}$ is paramagnetic.

In the light of the above statements, choose the correct answer from the options given below:

- (1) Statement I is false but Statement II is true (2) Both Statement I and Statement II are true
 (3) Both Statement I and Statement II are false (4) Statement I is true but Statement II is false

Answer (2)

Sol. In $[\text{Co}(\text{NH}_3)_6]^{3+}$, Co^{3+} ion is having $3d^6$ configuration.

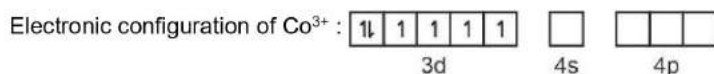

In presence of NH_3 ligand, pairing of electrons takes place and it becomes diamagnetic complex ion.

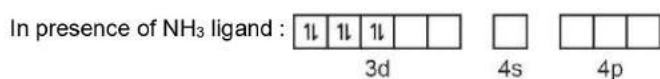

∴ $[\text{Co}(\text{NH}_3)_6]^{3+}$ is octahedral with d^2sp^3 hybridisation and it is diamagnetic in nature.

In case of $[\text{CoF}_6]^{3-}$, Co is in +3 oxidation state and it is having $3d^6$ configuration.

In presence of weak field F^- ligand, pairing does not take place.



∴ In $[\text{CoF}_6]^{3-}$, Co^{3+} is sp^3d^2 hybridised with four unpaired electrons, so it is paramagnetic in nature.

79. The compound that will undergo $\text{S}_\text{N}1$ reaction with the fastest rate is



Answer (1)

Sol. Reactivity towards $\text{S}_\text{N}1$ depends upon stability of carbocation.

Order of stability is

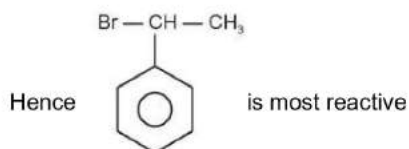
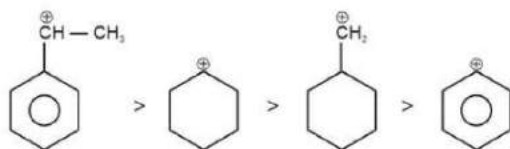

80. Given below are two statements:

Statement I : Aniline does not undergo Friedel-Crafts alkylation reaction.

Statement II : Aniline cannot be prepared through Gabriel synthesis.

In the light of the above statements, choose the correct answer from the options given below:

- (1) Statement I is incorrect but Statement II is true (2) Both statement I and Statement II are true
(3) Both Statement I and Statement II are false (4) Statement I is correct but Statement II is false

Answer (2)

Sol. • Aniline does not undergo Friedel-Crafts alkylation reaction due to salt formation with aluminium chloride, the Lewis acid, which is used as a catalyst.

- Aniline (aromatic primary amine) cannot be prepared by Gabriel phthalimide synthesis because aryl halides do not undergo nucleophilic substitution with anion formed by phthalimide.

81. 1 gram of sodium hydroxide was treated with 25 mL of 0.75 M HCl solution, the mass of sodium hydroxide left unreacted is equal to

- (1) 200 mg (2) 750 mg
(3) 250 mg (4) Zero mg

Answer (3)

$$\text{Sol. } M = \frac{W \times 1000}{M_2 \times V \text{ (in mL)}}$$

$$W = \frac{M \times M_2 \times V \text{ (in mL)}}{1000} = \frac{0.75 \times 36.5 \times 25}{1000}$$

$$= 0.684 \text{ g (Mass of HCl)}$$



36.5 g HCl reacts with NaOH = 40 g

$$0.684 \text{ g HCl reacts with NaOH} = \frac{40}{36.5} \times 0.684 = 0.750 \text{ g}$$

Amount of NaOH left = 1 g – 0.750 g = 0.250 g = 250 mg

82. The E° value for the $\text{Mn}^{3+}/\text{Mn}^{2+}$ couple is more positive than that of $\text{Cr}^{3+}/\text{Cr}^{2+}$ or $\text{Fe}^{3+}/\text{Fe}^{2+}$ due to change of

- (1) d^3 to d^5 configuration (2) d^5 to d^4 configuration
(3) d^5 to d^2 configuration (4) d^4 to d^5 configuration

Answer (4)

$$\text{Sol. } E^\circ_{\text{Mn}^{3+}/\text{Mn}^{2+}} > E^\circ_{\text{Cr}^{3+}/\text{Cr}^{2+}} \text{ or } E^\circ_{\text{Fe}^{3+}/\text{Fe}^{2+}}$$

Electronic configuration of $\text{Mn}^{3+} = [\text{Ar}]3d^4$

Electronic configuration of $\text{Mn}^{2+} = [\text{Ar}]3d^5$

Electronic configuration of $\text{Cr}^{3+} = [\text{Ar}]3d^3$

Electronic configuration of $\text{Cr}^{2+} = [\text{Ar}]3d^4$

As Mn^{3+} from d^4 configuration goes to more stable d^5 configuration (Half filled), due to more exchange energy in d^5 configuration.

83. The reagents with which glucose does **not** react to give the corresponding tests/products are

- A. Tollen's reagent
B. Schiff's reagent
C. HCN
D. NH_2OH
E. NaHSO_3

Choose the correct options from the given below:

- (1) E and D (2) B and C
(3) A and D (4) B and E

Answer (4)

Sol. Despite having the aldehyde group glucose does not give Schiff's test and it does not form the hydrogen sulphite addition product with NaHSO_3 .

84. Match List I with List II.

List I (Molecule)	List II (Number and types of bond/s between two carbon atoms)
A. ethane	I. one σ -bond and two π -bonds
B. ethene	II. two π -bonds
C. carbon molecule, C_2	III. one σ -bond
D. ethyne	IV. one σ -bond and one π -bond

Choose the correct answer from the options given below:

- (1) A-III, B-IV, C-I, D-II (2) A-I, B-IV, C-II, D-III
(3) A-IV, B-III, C-II, D-I (4) A-III, B-IV, C-II, D-I

Answer (4)

Sol. (A) Ethane	$\begin{array}{c} \text{H} & & \text{H} \\ & \diagdown & / \\ & \text{C} - & \text{C} \\ & / & \diagdown \\ \text{H} & & \text{H} \end{array}$	one (C – C) σ bond
(B) Ethene	$\begin{array}{c} \text{H} & & \text{H} \\ & \diagdown & / \\ & \text{C} = & \text{C} \\ & / & \diagdown \\ \text{H} & & \text{H} \end{array}$	one (C – C) σ and one (C – C) π bond
(C) C_2		two (C – C) π bonds
(D) Ethyne $\text{H} - \text{C} \equiv \text{C} - \text{H}$		two (C – C) π bonds and one (C – C) σ bond

85. Fehling's solution 'A' is

- (1) aqueous sodium citrate
(2) aqueous copper sulphate
(3) alkaline copper sulphate
(4) alkaline solution of sodium potassium tartrate (Rochelle's salt)

Answer (2)

Sol. Fehling solution 'A' = Aqueous copper sulphate

Fehling solution 'B' = Alkaline sodium potassium tartrate (Rochelle salt)

SECTION-B

86. Given below are certain cations. Using inorganic qualitative analysis, arrange them in increasing group number from 0 to VI.

- A. Al^{3+} B. Cu^{2+}
C. Ba^{2+} D. Co^{2+}
E. Mg^{2+}

Choose the correct answer from the options given below.

- (1) E, A, B, C, D (2) B, A, D, C, E
(3) B, C, A, D, E (4) E, C, D, B, A

Answer (2)

Sol.

Group	Cations
Group-II	Cu^{2+}
Group-III	Al^{3+}
Group-IV	Co^{2+}
Group-V	Ba^{2+}
Group-VI	Mg^{2+}

The correct order of group number of ions is $\text{Cu}^{2+} < \text{Al}^{3+} < \text{Co}^{2+} < \text{Ba}^{2+} < \text{Mg}^{2+}$
 (B) (A) (D) (C) (E)

∴ The correct order is B, A, D, C, E

87. Major products A and B formed in the following reaction sequence, are

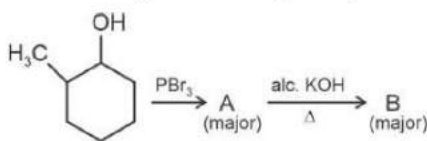

- (1) A = ; B =
- (2) A = ; B =
- (3) A = ; B =
- (4) A = ; B =

Answer (2)

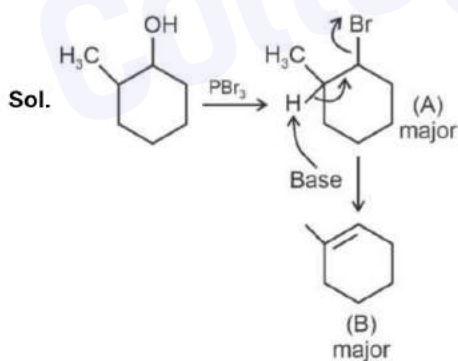

88. The rate of a reaction quadruples when temperature changes from 27°C to 57°C . Calculate the energy of activation.

Given $R = 8.314 \text{ J K}^{-1} \text{ mol}^{-1}$, $\log 4 = 0.6021$

- (1) 3804 kJ/mol (2) 38.04 kJ/mol
 (3) 380.4 kJ/mol (4) 3.80 kJ/mol

Answer (2)

Sol. $\log\left(\frac{k_2}{k_1}\right) = \frac{E_a}{2.303R} \left(\frac{1}{T_1} - \frac{1}{T_2}\right)$

$$\log\left(\frac{4}{1}\right) = \frac{E_a}{2.303R} \left(\frac{1}{300} - \frac{1}{330}\right)$$

$$E_a = \frac{(\log(4)) \times 2.303 \times 8.314 \times 300 \times 330}{30}$$

$$= 3.804 \times 10^4 \text{ J/mol}$$

$$= 38.04 \text{ kJ/mol}$$

89. Mass in grams of copper deposited by passing 9.6487 A current through a voltmeter containing copper sulphate solution for 100 seconds is (Given : Molar mass of Cu : 63 g mol^{-1} , $1 \text{ F} = 96487 \text{ C}$)

- (1) 0.0315 g (2) 3.15 g
(3) 0.315 g (4) 31.5 g

Answer (3)

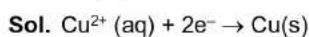

$$\text{Mass of Cu deposited (w)} = \frac{M \times i \times t}{nF}$$

$$= \frac{63 \times 9.6487 \times 100}{2 \times 96487}$$

$$= 0.315 \text{ g}$$

90. Identify the major product C formed in the following reaction sequence:

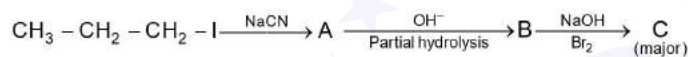

- (1) α -bromobutanoic acid (2) propylamine
(3) butylamine (4) butanamide

Answer (2)

Sol.

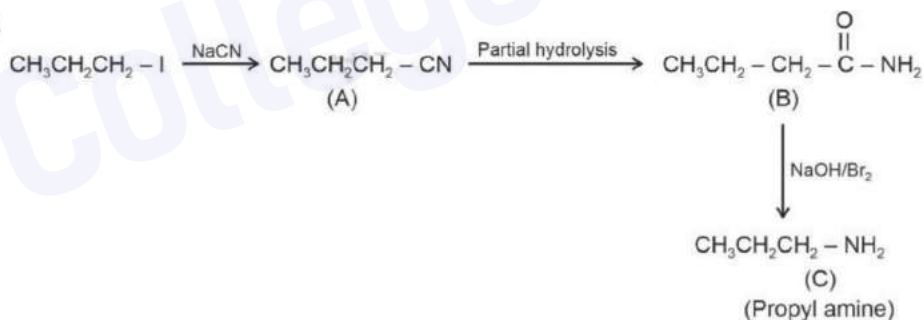

- Step-I is S_N reaction with CN^- nucleophile.
- Step-II will give amide.
- Step-III is Hoffmann bromamide degradation reaction.

91. The work done during reversible isothermal expansion of one mole of hydrogen gas at 25°C from pressure of 20 atmosphere to 10 atmosphere is

(Given $R = 2.0 \text{ cal K}^{-1} \text{ mol}^{-1}$)

- (1) 100 calories (2) 0 calorie
(3) -413.14 calories (4) 413.14 calories

Answer (3)

Sol. $W_{rev, iso} = -2.303 nRT \log \frac{P_i}{P_f}$
 $= -2.303 \times 1 \times 2 \times 298 \times \log 2$
 $= -2.303 \times 1 \times 2 \times 298 \times 0.3$
 $= -413.14 \text{ calories}$

92. Consider the following reaction in a sealed vessel at equilibrium with concentrations of $N_2 = 3.0 \times 10^{-3} \text{ M}$, $O_2 = 4.2 \times 10^{-3} \text{ M}$ and $NO = 2.8 \times 10^{-3} \text{ M}$.

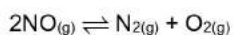

If 0.1 mol L^{-1} of $NO_{(g)}$ is taken in a closed vessel, what will be degree of dissociation (α) of $NO_{(g)}$ at equilibrium?

- (1) 0.717 (2) 0.00889
 (3) 0.0889 (4) 0.8889

Answer (1)

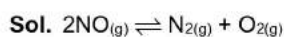

$$K_c = \frac{[N_2][O_2]}{[NO]^2}$$

$$= \frac{3 \times 10^{-3} \times 4.2 \times 10^{-3}}{2.8 \times 10^{-3} \times 2.8 \times 10^{-3}}$$

$$= 1.607$$

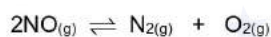

$t = 0$	0.1	0	0
	$0.1 - 0.1\alpha$	0.05α	0.05α

$$K_c = \frac{0.05\alpha \times 0.05\alpha}{(0.1 - 0.1\alpha)^2}$$

$$K_c = \frac{0.05\alpha \times 0.05\alpha}{0.01(1 - \alpha)^2}$$

$$1.607 = \frac{(0.05)^2 \alpha^2}{0.01(1 - \alpha)^2}$$

$$\frac{\alpha^2}{(1 - \alpha)^2} = \frac{1.607 \times (0.1)^2}{(0.05)^2}$$

$$\frac{\alpha}{1 - \alpha} = \frac{1.27 \times 0.1}{0.05}$$

$$\frac{\alpha}{1 - \alpha} = 2.54$$

$$\alpha = 2.54 - 2.54\alpha$$

$$3.54\alpha = 2.54$$

$$\alpha = \frac{2.54}{3.54} = 0.717$$

93. Given below are two statements :

Statement I : $[\text{Co}(\text{NH}_3)_6]^{3+}$ is a homoleptic complex whereas $[\text{Co}(\text{NH}_3)_4\text{Cl}_2]^+$ is a heteroleptic complex.

Statement II : Complex $[\text{Co}(\text{NH}_3)_6]^{3+}$ has only one kind of ligands but $[\text{Co}(\text{NH}_3)_4\text{Cl}_2]^+$ has more than one kind of ligands.

In the light of the above statements, choose the *correct* answer from the options given below.

- (1) Statement I is false but Statement II is true (2) Both Statement I and Statement II are true
(3) Both Statement I and Statement II are false (4) Statement I is true but Statement II is false

Answer (2)

Sol. $[\text{Co}(\text{NH}_3)_6]^{3+}$ is a homoleptic complex as only one type of ligands (NH_3) is coordinated with Co^{3+} ion. While $[\text{Co}(\text{NH}_3)_4\text{Cl}_2]^+$ is a heteroleptic complex in which Co^{3+} ion is ligated with more than one type of ligands, i.e., NH_3 and Cl^- .

94. The pair of lanthanoid ions which are diamagnetic is

- (1) Pm^{3+} and Sm^{3+} (2) Ce^{4+} and Yb^{2+}
(3) Ce^{3+} and Eu^{2+} (4) Gd^{3+} and Eu^{3+}

Answer (2)

Sol. Magnetic moment $\mu = \sqrt{n(n+2)}$

$n \rightarrow$ number of unpaired electron

$\text{Ce}^{4+} \Rightarrow (\text{Xe}) 4f^0$
 $\mu = 0$

Diamagnetic

$\text{Yb}^{2+} \Rightarrow (\text{Xe}) 4f^{14}$
 $\mu = 0$

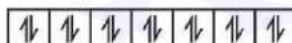

Diamagnetic

$\text{Ce}^{3+} \Rightarrow (\text{Xe}) 4f^1$
 $\mu = \sqrt{3}$

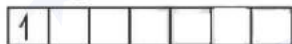

Paramagnetic

$\text{Eu}^{2+} \Rightarrow (\text{Xe}) 4f^7$
 $\mu = \sqrt{63}$



Paramagnetic

$\text{Gd}^{3+} \Rightarrow (\text{Xe}) 4f^7$
 $\mu = \sqrt{63}$



Paramagnetic

$\text{Eu}^{3+} \Rightarrow (\text{Xe}) 4f^6$
 $\mu = \sqrt{48}$

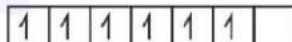

Paramagnetic

$\text{Pm}^{3+} \Rightarrow (\text{Xe}) 4f^4$
 $\mu = \sqrt{24}$

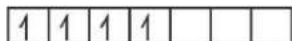

Paramagnetic

$\text{Sm}^{3+} \Rightarrow (\text{Xe}) 4f^5$
 $\mu = \sqrt{35}$

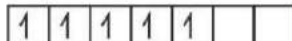

Paramagnetic

Hence Ce^{4+} and Yb^{2+} are only diamagnetic.

95. During the preparation of Mohr's salt solution (Ferrous ammonium sulphate), which of the following acid is added to prevent hydrolysis of Fe^{2+} ion?

- (1) dilute sulphuric acid (2) dilute hydrochloric acid
(3) concentrated sulphuric acid (4) dilute nitric acid

Answer (1)

Sol. During the preparation of Mohr's salt, dilute sulphuric acid is added to prevent the hydrolysis of Fe^{2+} ion.

96. The products A and B obtained in the following reactions, respectively, are

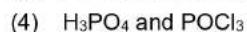
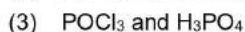
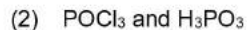
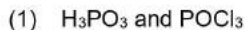
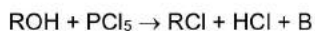

Answer (1)

Sol. These reactions are preparation of haloalkanes from alcohols.

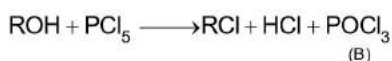

A and B are H_3PO_3 and POCl_3 respectively.

97. For the given reaction:

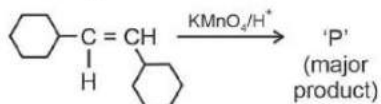

'P' is

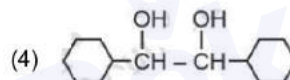
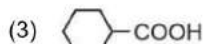
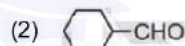
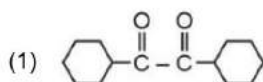

Answer (3)

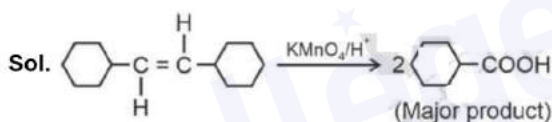

98. A compound X contains 32% of A, 20% of B and remaining percentage of C. Then, the empirical formula of X is :

(Given atomic masses of A = 64; B = 40; C = 32 u)

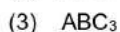
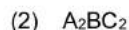

Answer (3)

Sol.

Element	Mass percentage %	No. of moles	No. of moles/Smallest number	Simplest whole number
A	32%	$\frac{32}{64} = \frac{1}{2}$	$\frac{1}{2} \times 2$	= 1
B	20%	$\frac{20}{40} = \frac{1}{2}$	$\frac{1}{2} \times 2$	= 1
C	48%	$\frac{48}{32} = \frac{3}{2}$	$\frac{3}{2} \times 2$	= 3

So, empirical formula of X = $\begin{matrix} A & : & B & : & C \\ 1 & : & 1 & : & 3 \end{matrix}$

∴ The correct empirical formula of compound X is ABC₃

99. The plot of osmotic pressure (Π) vs concentration (mol L⁻¹) for a solution gives a straight line with slope 25.73 L bar mol⁻¹. The temperature at which the osmotic pressure measurement is done is

(Use R = 0.083 L bar mol⁻¹ K⁻¹)

- (1) 12.05°C
- (2) 37°C
- (3) 310°C
- (4) 25.73°C

Answer (2)

Sol. Π = CRT

Slope = RT

$$25.73 = 0.083 \times T$$

$$T = \frac{25.73}{0.083} = 309.47 \approx 310 \text{ K}$$

$$\begin{aligned} \therefore \text{Temperature in } ^\circ\text{C} &= 310 - 273 \\ &= 37^\circ\text{C} \end{aligned}$$

100. Identify the **correct** answer.

- (1) Three canonical forms can be drawn for CO₃²⁻ ion
- (2) Three resonance structures can be drawn for ozone
- (3) BF₃ has non-zero dipole moment
- (4) Dipole moment of NF₃ is greater than that of NH₃

Answer (1)

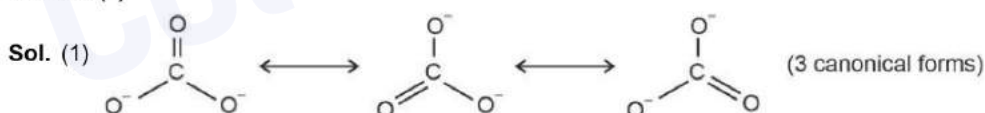

- (2) In ozone; there are two resonating structures.

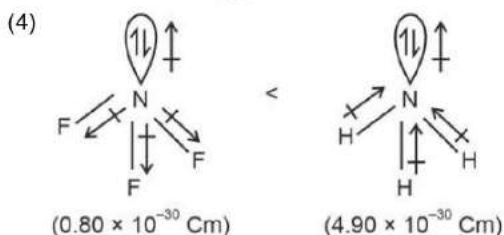
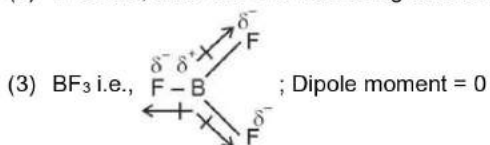

BOTANY

SECTION-A

101. Given below are two statements:

Statement I : Parenchyma is living but collenchyma is dead tissue.

Statement II : Gymnosperms lack xylem vessels but presence of xylem vessels is the characteristic of angiosperms.

In the light of the above statements, choose the correct answer from the options given below:

- (1) Statement I is false but Statement II is true
- (2) Both Statement I and Statement II are true
- (3) Both Statement I and Statement II are false
- (4) Statement I is true but Statement II is false

Answer (1)

Sol. Collenchyma is also living tissue.

Gymnosperm lack xylem vessels but presence of xylem vessels is the characteristic of angiosperm.

102. Identify the part of the seed from the given figure which is destined to form root when the seed germinates.

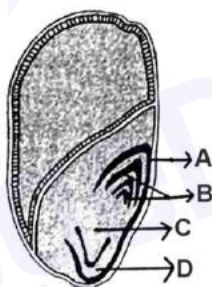

- | | |
|-------|-------|
| (1) D | (2) A |
| (3) B | (4) C |

Answer (4)

Sol. Radicle is destined to form root.

In the given diagram 'C' represent radicle

103. Which one of the following is not a criterion for classification of fungi?

- (1) Fruiting body
- (2) Morphology of mycelium
- (3) Mode of nutrition
- (4) Mode of spore formation

Answer (3)

Sol. The morphology of the mycelium, mode of spore formation and fruiting bodies form the basis for the division of the kingdom fungi into various classes.

104. Tropical regions show greatest level of species richness because
- Tropical latitudes have remained relatively undisturbed for millions of years, hence more time was available for species diversification.
 - Tropical environments are more seasonal.
 - More solar energy is available in tropics.
 - Constant environments promote niche specialization.
 - Tropical environments are constant and predictable.

Choose the correct answer from the options given below.

- A, B and D only
- A, C, D and E only
- A and B only
- A, B and E only

Answer (2)

Sol. Only statement B is incorrect because tropical environments unlike temperate ones, are less seasonal, relatively more constant and predictable.

Thus statements A, C, D and E are correct.

105. Which of the following is an example of actinomorphic flower?

- Sesbania*
- Datura*
- Cassia*
- Pisum*

Answer (2)

Sol. *Datura* shows actinomorphic flower. In *Cassia*, *Pisum* and *Sesbania*, zygomorphic flowers are seen.

106. Spindle fibers attach to kinetochores of chromosomes during

- | | |
|---------------|--------------|
| (1) Telophase | (2) Prophase |
| (3) Metaphase | (4) Anaphase |

Answer (3)

Sol. Spindle fibers attach to kinetochores of chromosome in metaphase stage.

107. The type of conservation in which the threatened species are taken out from their natural habitat and placed in special setting where they can be protected and given special care is called

- Sustainable development
- in-situ* conservation
- Biodiversity conservation
- Semi-conservative method

Answer (3)

Sol. The type of conservation in which threatened species are taken out from their natural habitat and placed in special setting where they can be protected and given special care is called *ex-situ* conservation which is a type of biodiversity conservation.

108. Formation of interfascicular cambium from fully developed parenchyma cells is an example for

- (1) Maturation
- (2) Differentiation
- (3) Redifferentiation
- (4) Dedifferentiation

Answer (4)

Sol. The phenomenon of formation of interfascicular cambium from fully differentiated parenchyma cells is called dedifferentiation.

109. Identify the set of **correct** statements:

- A. The flowers of *Vallisneria* are colourful and produce nectar.
- B. The flowers of water lily are not pollinated by water.
- C. In most of water-pollinated species, the pollen grains are protected from wetting.
- D. Pollen grains of some hydrophytes are long and ribbon like.
- E. In some hydrophytes, the pollen grains are carried passively inside water.

Choose the correct answer from the options given below.

- (1) B, C, D and E only
- (2) C, D and E only
- (3) A, B, C and D only
- (4) A, C, D and E only

Answer (1)

Sol. Flowers of *Vallisneria* are not colourful and do not produce nectar. Waterlily is pollinated by insect or wind. In water-pollinated species, pollen grains are protected from wetting by a mucilaginous covering. In some hydrophytes such as *Vallisneria* pollen grains are carried passively by water current.

110. A transcription unit in DNA is defined primarily by the three regions in DNA and these are with respect to upstream and down stream end;

- (1) Promotor, Structural gene, Terminator
- (2) Repressor, Operator gene, Structural gene
- (3) Structural gene, Transposons, Operator gene
- (4) Inducer, Repressor, Structural gene

Answer (1)

Sol. A transcription unit of DNA is defined primarily by the three regions in the DNA:

- (i) A promoter
- (ii) The structural gene
- (iii) A terminator

The promoter is said to be located towards 5'-end (upstream) of the structural gene (the reference is made with respect to the polarity of coding strand)

The terminator is located towards 3'-end (downstream) of the coding strand.

111. Given below are two statements:

Statement I : Chromosomes become gradually visible under light microscope during leptotene stage.

Statement II : The beginning of diplotene stage is recognized by dissolution of synaptonemal complex.

In the light of the above statements, choose the correct answer from the options given below:

- (1) Statement I is false but Statement II is true (2) Both Statement I and Statement II are true
(3) Both Statement I and Statement II are false (4) Statement I is true but Statement II is false

Answer (2)

Sol. • During leptotene stage the chromosomes become gradually visible under the light microscope.
• The beginning of diplotene is recognised by the dissolution of the synaptonemal complex and the tendency of the recombined homologous chromosomes of the bivalents to separate from each other except at the site of crossover.

Thus both statement I and II are correct.

112. The capacity to generate a whole plant from any cell of the plant is called:

- (1) Somatic hybridization (2) Totipotency
(3) Micropropagation (4) Differentiation

Answer (2)

Sol. Totipotency is defined as the capacity to generate a whole plant from any cell of the plant.

113. In the given figure, which component has thin outer walls and highly thickened inner walls?

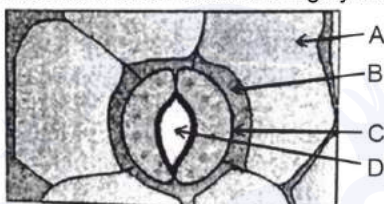

- (1) B (2) C
(3) D (4) A

Answer (2)

Sol. Guard cells of stomata have thin outer wall and highly thickened inner walls.

114. Match List I with List II

	List-I		List-II
A.	<i>Rhizopus</i>	I.	Mushroom
B.	<i>Ustilago</i>	II.	Smut fungus
C.	<i>Puccinia</i>	III.	Bread mould
D.	<i>Agaricus</i>	IV.	Rust fungus

Choose the correct answer from the options given below:

- (1) A-IV, B-III, C-II, D-I (2) A-III, B-II, C-IV, D-I
(3) A-I, B-III, C-II, D-IV (4) A-III, B-II, C-I, D-IV

Answer (2)

Sol. *Rhizopus* is a bread mould fungus. *Ustilago* is a smut fungi. *Puccinia* is known as rust fungi. *Agaricus* is commonly called mushroom.

- A-III
B-II
C-IV
D-I

115. Match List I with List II

	List-I		List-II
A.	Nucleolus	I.	Site of formation of glycolipid
B.	Centriole	II.	Organization like the cartwheel
C.	Leucoplasts	III.	Site for active ribosomal RNA synthesis
D.	Golgi apparatus	IV.	For storing nutrients

Choose the correct answer from the options given below:

- (1) A-I, B-II, C-III, D-IV
- (2) A-III, B-II, C-IV, D-I
- (3) A-II, B-III, C-I, D-IV
- (4) A-III, B-IV, C-II, D-I

Answer (2)

Sol. • Nucleolus is a site for active ribosomal RNA synthesis

- Both the centrioles in a centrosome lie perpendicular to each other in which each has an organisation like the cartwheel.
- Leucoplasts are the colourless plastids of varied shapes and sizes with stored nutrients.
- Golgi apparatus is the important site for formation of glycoproteins and glycolipids.

116. List of endangered species was released by

- | | |
|----------|----------|
| (1) IUCN | (2) GEAC |
| (3) WWF | (4) FOAM |

Answer (1)

Sol. List of endangered species was released by – IUCN.

117. The lactose present in the growth medium of bacteria is transported to the cell by the action of

- (1) Polymerase
- (2) Beta-galactosidase
- (3) Acetylase
- (4) Permease

Answer (4)

Sol. The γ gene *lac* operon codes for permease enzyme, which increase the permeability of cell to β -galactosides.

So, the lactose present in the growth medium of bacteria is transported into the cell by the action of permease.

118. The cofactor of the enzyme carboxypeptidase is:

- (1) Haem
- (2) Zinc
- (3) Niacin
- (4) Flavin

Answer (2)

Sol. The correct answer is option (2) as the cofactor of the enzyme carboxypeptidase is zinc.

Niacin is associated with coenzyme NAD and NADP.

Option (1) is incorrect as haem is the prosthetic group in peroxidase and catalase.

119. Lecithin, a small molecular weight organic compound found in living tissues, is an example of:

- (1) Carbohydrates
- (2) Amino acids
- (3) Phospholipids
- (4) Glycerides

Answer (3)

Sol. The correct answer is option (3).

Some lipids have phosphorous and a phosphorylated organic compound in them. These are phospholipids. They are found in cell membrane. Lecithin is one example.

Option (4) is incorrect as glycerides are another group of lipids in which both glycerol and fatty acids are present.

Option (1) and (2) are incorrect as carbohydrates and amino acids are separate groups of biomolecules.

120. Match List I with List II

List I	List II
A. <i>Clostridium butylicum</i>	I. Ethanol
B. <i>Saccharomyces cerevisiae</i>	II. Streptokinase
C. <i>Trichoderma polysporum</i>	III. Butyric acid
D. <i>Streptococcus sp.</i>	IV. Cyclosporin-A

Choose the correct answer from the options given below:

- (1) A-IV, B-I, C-III, D-II
- (2) A-III, B-I, C-II, D-IV
- (3) A-II, B-IV, C-III, D-I
- (4) A-III, B-I, C-IV, D-II

Answer (4)

Sol.

A. <i>Clostridium butylicum</i>	—	Butyric acid
B. <i>Saccharomyces cerevisiae</i>	—	Ethanol
C. <i>Trichoderma polysporum</i>	—	Cyclosporin-A
D. <i>Streptococcus sp.</i>	—	Streptokinase

121. Identify the type of flowers based on the position of calyx, corolla and androecium with respect to the ovary from the given figures (a) and (b)

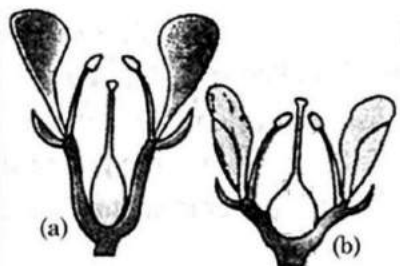

- (1) (a) Perigynous; (b) Perigynous
- (2) (a) Epigynous; (b) Hypogynous
- (3) (a) Hypogynous; (b) Epigynous
- (4) (a) Perigynous; (b) Epigynous

Answer (1)

Sol. If gynoecium is situated in the centre and other parts of the flower are located on the rim of the thalamus almost at the same level, it is called perigynous.

Both diagram shows perigynous condition.

122. Bulliform cells are responsible for

- (1) Providing large spaces for storage of sugars.
- (2) Inward curling of leaves in monocots.
- (3) Protecting the plant from salt stress.
- (4) Increased photosynthesis in monocots.

Answer (2)

Sol. In grasses, certain adaxial epidermal cells along the veins modify themselves into large, empty, colourless cells. These are called bulliform cells. When the bulliform cells in the leaves have absorbed water and are turgid, the leaf surface is exposed. When they are flaccid due to water stress, they make the leaves curl inwards to minimise water loss.

123. In a plant, black seed color (BB/Bb) is dominant over white seed color (bb). In order to find out the genotype of the black seed plant, with which of the following genotype will you cross it?

- (1) BB/Bb
- (2) BB
- (3) bb
- (4) Bb

Answer (3)

Sol. To determine the genotype of a black seed colour at F_2 , the black seed from F_2 is crossed with the white seed colour. This is called a test cross.

\therefore To determine the genotype of (BB/Bb) black seed we need to cross them with white seed *i.e.* bb.

124. Auxin is used by gardeners to prepare weed-free lawns. But no damage is caused to grass as auxin
- (1) can help in cell division in grasses, to produce growth.
 - (2) promotes apical dominance.
 - (3) promotes abscission of mature leaves only.
 - (4) does not affect mature monocotyledonous plants.

Answer (4)

Sol. Auxin does not affect mature monocot plants. In monocots, especially grasses show limited translocation and cause rapid degradation of external auxin.

125. Which one of the following can be explained on the basis of Mendel's Law of Dominance?
- A. Out of one pair of factors one is dominant and the other is recessive.
 - B. Alleles do not show any expression and both the characters appear as such in F_2 generation.
 - C. Factors occur in pairs in normal diploid plants.
 - D. The discrete unit controlling a particular character is called factor.
 - E. The expression of only one of the parental characters is found in a monohybrid cross.

Choose the correct answer from the options given below:

- (1) A, B, C, D and E
- (2) A, B and C only
- (3) A, C, D and E only
- (4) B, C and D only

Answer (3)

Sol. According to Law of Dominance

- (1) Characters are controlled by discrete units called factors
- (2) Factors occur in pairs
- (3) In a dissimilar pair of factors one member of the pair dominates (dominant) the other recessive

The law of dominance is used to explain the expression of only one of the parental characters in a monohybrid cross.

Law of segregation is based on the fact that the alleles do not show any expression and both the characters are recovered as such in F_2 generation

126. Inhibition of Succinic dehydrogenase enzyme by malonate is a classical example of:
- (1) Enzyme activation
 - (2) Cofactor inhibition
 - (3) Feedback inhibition
 - (4) Competitive inhibition

Answer (4)

Sol. Correct answer is option (4) because malonate shows close structural similarity with the substrate and it competes with the substrate for the substrate binding site of the enzyme succinic dehydrogenase. Option (1), (2) and (3) are incorrect as enzyme activation, co-factor inhibition are not showing structural similarity with substrate.

127. What is the fate of a piece of DNA carrying only gene of interest which is transferred into an alien organism?
- The piece of DNA would be able to multiply itself independently in the progeny cells of the organism.
 - It may get integrated into the genome of the recipient.
 - It may multiply and be inherited along with the host DNA.
 - The alien piece of DNA is not an integral part of chromosome.
 - It shows ability to replicate.

Choose the correct answer from the options given below:

- A and E only
- A and B only
- D and E only
- B and C only

Answer (4)

Sol. Correct answer is option (4) because

The fate of a piece of DNA carrying only gene of interest which is transferred into an alien organism are:

(B) It may get integrated into the genome of the recipient

(C) It may multiply and be inherited along with the host DNA

⇒ This piece of DNA would not be able to multiply itself in the progeny cells of the organism but when gets integrated into the genome of the recipient, it may multiply and be inherited along with the host DNA.

128. A pink flowered Snapdragon plant was crossed with a red flowered Snapdragon plant. What type of phenotype/s is/are expected in the progeny?
- Red, Pink as well as white flowered plants
 - Only red flowered plants
 - Red flowered as well as pink flowered plants
 - Only pink flowered plants

Answer (3)

Sol. Pink colour flower in snapdragon have genotype **Rr**

Red flowered snapdragon have genotype **RR** when they both are crossed

$\begin{matrix} + \\ \ominus \end{matrix}$	R	R
R	RR	RR
r	Rr	Rr

Phenotype

Red : Pink : White

2 2 0

So the progeny that we get are red and pink flowered plants only

129. These are regarded as major causes of biodiversity loss:

- A. Over exploitation
- B. Co-extinction
- C. Mutation
- D. Habitat loss and fragmentation
- E. Migration

Choose the correct option:

- (1) A, B and D only
- (2) A, C and D only
- (3) A, B, C and D only
- (4) A, B and E only

Answer (1)

Sol. Major causes of biodiversity losses are

- (1) Co-extinctions
- (2) Habitat loss and fragmentation
- (3) Over-exploitation
- (4) Alien species invasions

Hence correct option is A, B and D only.

130. Which of the following are required for the dark reaction of photosynthesis?

- A. Light
- B. Chlorophyll
- C. CO_2
- D. ATP
- E. NADPH

Choose the **correct** answer from the options given below:

- (1) D and E only
- (2) A, B and C only
- (3) B, C and D only
- (4) C, D and E only

Answer (4)

Sol. For dark reaction of photosynthesis there are the requirement of

CO_2]
ATP	
NADPH	

131. Match List I with List II

List I	List II
A. Two or more alternative forms of a gene	I. Back cross
B. Cross of F ₁ progeny with homozygous recessive parent	II. Ploidy
C. Cross of F ₁ progeny with any of the parents	III. Allele
D. Number of chromosome sets in plant	IV. Test cross

Choose the **correct** answer from the options given below:

- (1) A-IV, B-III, C-II, D-I
- (2) A-I, B-II, C-III, D-IV
- (3) A-II, B-I, C-III, D-IV
- (4) A-III, B-IV, C-I, D-II

Answer (4)

- Sol.** A. Two or more alternative forms of gene are called alleles.
 B. Cross of F₁ progeny with homozygous recessive parent is a test cross.
 C. Cross of F₁ progeny with any of the parents is a back cross.
 D. Number of chromosome sets in plant is called ploidy.

132. Hind II always cuts DNA molecules at a particular point called recognition sequence and it consists of:

- (1) 10 bp
- (2) 8 bp
- (3) 6 bp
- (4) 4 bp

Answer (3)

Sol. The correct answer is option (3).

The first restriction endonuclease – *Hind* II, whose functioning depends on a specific DNA nucleotide sequence was isolated. It was found that *Hind* II always cut DNA molecules at a particular point by recognising sequence of six base pairs.

Option (1), (2) and (4) are incorrect because they have either more than 6 or less than 6 bp.

133. The equation of Verhulst-Pearl logistic growth is $\frac{dN}{dt} = rN \left[\frac{K - N}{K} \right]$.

From this equation, K indicates:

- (1) Population density
- (2) Intrinsic rate of natural increase
- (3) Biotic potential
- (4) Carrying capacity

Answer (4)

Sol. In the equation $\frac{dN}{dt} = rN \left(\frac{K - N}{K} \right)$, K represents carrying capacity.

134. How many molecules of ATP and NADPH are required for every molecule of CO_2 fixed in the Calvin cycle?
- (1) 3 molecules of ATP and 2 molecules of NADPH
 - (2) 2 molecules of ATP and 3 molecules of NADPH
 - (3) 2 molecules of ATP and 2 molecules of NADPH
 - (4) 3 molecules of ATP and 3 molecules of NADPH

Answer (1)

Sol. For fixation of 1 molecule of CO_2 in Calvin cycle 3 ATP molecules and 2 NADPH molecules are required.

135. Given below are two statements:

Statement I : Bt toxins are insect group specific and coded by a gene *cry IAc*.

Statement II : Bt toxin exists as inactive protoxin in *B. thuringiensis*. However, after ingestion by the insect the inactive protoxin gets converted into active form due to acidic pH of the insect gut.

In the light of the above statements, choose the correct answer from the options given below:

- (1) Statement I is false but Statement II is true
- (2) Both Statement I and Statement II are true
- (3) Both Statement I and Statement II are false
- (4) Statement I is true but Statement II is false

Answer (4)

Sol. The correct answer is option (4) as specific Bt toxin genes were isolated from *Bacillus thuringiensis* and incorporated into the several crop plants such as cotton. The choice of genes depends upon the crop and the targeted pest as most Bt toxins are insect-group specific. The toxin is coded by a gene named *cry*. There are a number of them, for example, the proteins encoded by the genes *cry IAc* and *cry IIAb* control the cotton bollworms, that of *cry IAb* controls corn borer.

SECTION-B

136. Match List-I with List-II

List-I	List-II
A. GLUT-4	I. Hormone
B. Insulin	II. Enzyme
C. Trypsin	III. Intercellular ground substance
D. Collagen	IV. Enables glucose transport into cells

Choose the correct answer from the options given below.

- (1) A-III, B-IV, C-I, D-II
- (2) A-IV, B-I, C-II, D-III
- (3) A-I, B-II, C-III, D-IV
- (4) A-II, B-III, C-IV, D-I

Answer (2)

Sol. Correct answer is option (2)

A. GLUT-4	IV. Enables glucose transport into cells
B. Insulin	I. Hormone
C. Trypsin	II. Enzyme
D. Collagen	III. Intercellular ground substance

137. Match List I with List II

List I (Types of Stamens)	List II (Example)
A. Monoadelphous	I. Citrus
B. Diadelphous	II. Pea
C. Polyadelphous	III. Lily
D. Epiphyllous	IV. China-rose

Choose the correct answer from the options given below:

- (1) A-III, B-I, C-IV, D-II
- (2) A-IV, B-II, C-I, D-III
- (3) A-IV, B-I, C-II, D-III
- (4) A-I, B-II, C-IV, D-III

Answer (2)

Sol. In China rose monoadelphous androecium is present.

Diadelphous androecium is found in pea plant.

Polyadelphous androecium is found in citrus.

Epiphyllous androecium is found in lily.

138. Match List I with List II

	List I		List II
A.	Citric acid cycle	I.	Cytoplasm
B.	Glycolysis	II.	Mitochondrial matrix
C.	Electron transport system	III.	Intermembrane space of mitochondria
D.	Proton gradient	IV.	Inner mitochondrial membrane

Choose the correct answer from the options given below:

- (1) A-IV, B-III, C-II, D-I
- (2) A-I, B-II, C-III, D-IV
- (3) A-II, B-I, C-IV, D-III
- (4) A-III, B-IV, C-I, D-II

Answer (3)

Sol. Citric acid cycle occurs in mitochondrial matrix.

Glycolysis occurs in cytosol in most of the organism.

Electron transport system is present in the inner mitochondrial membrane.

Proton gradient is formed across the intermembrane space of mitochondria.

139. Match List I with List II

List I

- A. Robert May
- B. Alexander von Humboldt
- C. Paul Ehrlich
- D. David Tilman

List II

- I. Species-Area relationship
- II. Long term ecosystem experiment using out door plots
- III. Global species diversity at about 7 million
- IV. Rivet popper hypothesis

Choose the correct answer from the options given below:

- (1) A-III, B-IV, C-II, D-I
- (2) A-II, B-III, C-I, D-IV
- (3) A-III, B-I, C-IV, D-II
- (4) A-I, B-III, C-II, D-IV

Answer (3)

Sol. Robert May places the global species diversity at about 7 million.

Alexander von Humboldt gave species-area relationship.

Paul Ehrlich used an analogy "Rivet popper hypothesis" to explain the role of species in the ecosystem.

David Tilman performed long term ecosystem experiments using out door plots.

140. Given below are two statements:

Statement I: In C_3 plants, some O_2 binds to RuBisCO, hence CO_2 fixation is decreased.

Statement II: In C_4 plants, mesophyll cells show very little photorespiration while bundle sheath cells do not show photorespiration.

In the light of the above statements, choose the *correct* answer from the options given below:

- (1) Statement I is false but Statement II is true
- (2) Both Statement I and Statement II are true
- (3) Both Statement I and Statement II are false
- (4) Statement I is true but Statement II is false

Answer (4)

Sol. In C_3 plant, some O_2 bind to RuBisCO, and hence CO_2 fixation is decreased. Statement II is incorrect, photorespiration does not occur in C_4 plants as they lack RuBisCO in mesophyll. Hence statement I is the only correct option.

141. Match List I with List II

List I

- A. Frederick Griffith
- B. Francois Jacob & Jacque Monod
- C. Har Gobind Khorana
- D. Meselson & Stahl

List II

- I. Genetic code
- II. Semi-conservative mode of DNA replication
- III. Transformation
- IV. *Lac* operon

Choose the correct answer from the options given below:

- (1) A-IV, B-I, C-II, D-III
- (2) A-III, B-II, C-I, D-IV
- (3) A-III, B-IV, C-I, D-II
- (4) A-II, B-III, C-IV, D-I

Answer (3)

Sol. Frederick Griffith series of experiment witness miraculous transformation in the bacteria.

The elucidation of *Lac* operon was a result of a close association between geneticist, Francois Jacob and a biochemist, Jacques Monod.

Meselson and Stahl gave semi-conservative mode of DNA replication.

Har Gobind Khorana developed chemical method to define combination of bases in genetic code.

142. In an ecosystem if the Net Primary Productivity (NPP) of first trophic level is $100x$ (kcal m^{-2}) yr^{-1} , what would be the GPP (Gross Primary Productivity) of the third trophic level of the same ecosystem?

(1) $\frac{100x}{3x}$ (kcal m^{-2}) yr^{-1}

(2) $\frac{x}{10}$ (kcal m^{-2}) yr^{-1}

(3) x (kcal m^{-2}) yr^{-1}

(4) $10x$ (kcal m^{-2}) yr^{-1}

Answer (4)

Sol. NPP at first trophic level would be the GPP for second trophic level. NPP at second trophic level would be GPP for third trophic level. Therefore, $100x$ ($\text{kcal/m}^2/\text{yr}$) would be GPP at second trophic level and $100x \times 10\%$ ($\text{kcal/m}^2/\text{yr}$) i.e., $10x$ ($\text{kcal/m}^2/\text{yr}$) energy would be GPP at third trophic level.

143. Identify the step in tricarboxylic acid cycle, which does not involve oxidation of substrate.

(1) Isocitrate \rightarrow α -ketoglutaric acid

(2) Malic acid \rightarrow Oxaloacetic acid

(3) Succinic acid \rightarrow Malic acid

(4) Succinyl-CoA \rightarrow Succinic acid

Answer (4)

Sol. Oxidation involves the loss of electrons (often as part of hydrogen) from a molecule, leaving to an increase in its oxidation state. This process is typically associated with the transfer of electrons to an electron acceptor which is reduced in the process.

The conversion of succinyl CoA to succinic acid does not involve oxidation of substrate.

144. The DNA present in chloroplast is:

(1) Circular, single stranded

(2) Linear, double stranded

(3) Circular, double stranded

(4) Linear, single stranded

Answer (3)

Sol. The DNA present in chloroplast is circular double stranded.

145. Read the following statements and choose the set of correct statements:

In the members of Phaeophyceae,

- A. Asexual reproduction occurs usually by biflagellate zoospores.
- B. Sexual reproduction is by oogamous method only.
- C. Stored food is in the form of carbohydrates which is either mannitol or laminarin.
- D. The major pigments found are chlorophyll a, c and carotenoids and xanthophyll.
- E. Vegetative cells have a cellulosic wall, usually covered on the outside by gelatinous coating of algin.

Choose the correct answer from the options given below:

- (1) A, B, C and E only
- (2) A, B, C and D only
- (3) B, C, D and E only
- (4) A, C, D and E only

Answer (4)

Sol. In members of Phaeophyceae sexual reproduction is by oogamous, isogamous or anisogamous methods.

Therefore correct set of statements are A, C, D and E.

146. Which of the following statement is correct regarding the process of replication in *E.coli*?

- (1) The DNA dependent DNA polymerase catalyses polymerization in 5' → 3' direction
- (2) The DNA dependent DNA polymerase catalyses polymerization in one direction that is 3' → 5'
- (3) The DNA dependent RNA polymerase catalyses polymerization in one direction, that is 5' → 3'
- (4) The DNA dependent DNA polymerase catalyses polymerization in 5' → 3' as well as 3' → 5' direction

Answer (1)

Sol. In Prokaryotes, like *E.coli* during replication, the DNA dependent DNA polymerase catalyse polymerization only in one direction, that is 5' → 3'

147. Match List I with List II

List I

- A. Rose
- B. Pea
- C. Cotton
- D. Mango

List II

- I. Twisted aestivation
- II. Perigynous flower
- III. Drupe
- IV. Marginal placentation

Choose the correct answer from the options given below :

- (1) A-II, B-III, C-IV, D-I
- (2) A-II, B-IV, C-I, D-III
- (3) A-I, B-II, C-III, D-IV
- (4) A-IV, B-III, C-II, D-I

Answer (2)

Sol. Rose have half-inferior ovary, thus it is known as Perigynous flower.

In Pea, the placenta form a ridge along the ventral suture of the ovary and ovules are borne on this ridge forming two rows.

In Cotton, twisted aestivation is present.

In Mango, fruit is drupe.

148. Spraying sugarcane crop with which of the following plant growth regulators, increases the length of stem, thus, increasing the yield?

- (1) Abscisic acid
- (2) Auxin
- (3) Gibberellin
- (4) Cytokinin

Answer (3)

Sol. Sugarcanes store carbohydrate as sugar in their stems. Spraying sugarcane crop with gibberellins increases the length of the stem, thus increasing the yield.

149. Which of the following are fused in somatic hybridization involving two varieties of plants?

- (1) Pollens
- (2) Callus
- (3) Somatic embryos
- (4) Protoplasts

Answer (4)

Sol. Protoplast of two varieties of plants are fused in somatic hybridization.

150. Identify the correct description about the given figure:



- (1) Compact inflorescence showing complete autogamy
- (2) Wind pollinated plant inflorescence showing flowers with well exposed stamens.
- (3) Water pollinated flowers showing stamens with mucilaginous covering.
- (4) Cleistogamous flowers showing autogamy.

Answer (2)

Sol. The given diagram shows a wind pollinated plant showing compact inflorescence and well exposed stamens.

Stamens are exposed so complete autogamy does not occur.

ZOOLOGY

SECTION-A

151. Match **List I** with **List II** :

List I	List II
A. α -I antitrypsin	I. Cotton bollworm
B. Cry IAb	II. ADA deficiency
C. Cry IAc	III. Emphysema
D. Enzyme replacement therapy	IV. Corn borer

Choose the correct answer form the options given below:

- (1) A-II, B-IV, C-I, D-III
- (2) A-II, B-I, C-IV, D-III
- (3) A-III, B-I, C-II, D-IV
- (4) A-III, B-IV, C-I, D-II

Answer (4)

Sol. The correct answer is option (4) as

α -I antitrypsin → Is used for treatment of Emphysema

Cry I Ab gene → Controls corn borer

Cry I Ac gene → Controls cotton bollworms

Enzyme replacement therapy → Can be used as treatment option in ADA deficiency.

152. Which of the following is not a component of Fallopian tube?

- (1) Ampulla
- (2) Uterine fundus
- (3) Isthmus
- (4) Infundibulum

Answer (2)

Sol. The correct answer is option (2) as uterine fundus is the upper, dome-shaped part of the uterus, above the opening of fallopian tubes.

- Option (1) is incorrect as ampulla is the wider part of the oviduct.
- Option (3) is incorrect as isthmus is the last and narrow part of the oviduct that links to the uterus.
- Option (4) is incorrect as infundibulum is the part of oviduct which is closer to the ovary.

153. The "Ti plasmid" of *Agrobacterium tumefaciens* stands for

- (1) Temperature independent plasmid
- (2) Tumour inhibiting plasmid
- (3) Tumor independent plasmid
- (4) Tumor inducing plasmid

Answer (4)

Sol. The correct answer is option (4) as Ti plasmid of *Agrobacterium tumefaciens* is tumor inducing plasmid, containing T-DNA which causes tumor in several dicot plants.

Options (1), (2) and (3) are not correct.

154. Which one of the following factors will not affect the Hardy-Weinberg equilibrium?

- (1) Constant gene pool
- (2) Genetic recombination
- (3) Genetic drift
- (4) Gene migration

Answer (1)

Sol. The correct answer is option (1) as a constant gene pool will not disturb the Hardy-Weinberg equilibrium. Option (2), (3) & (4) will affect the equilibrium leading to evolution.

155. Following are the stages of pathway for conduction of an action potential through the heart

- | | |
|--------------|--------------------|
| A. AV bundle | B. Purkinje fibres |
| C. AV node | D. Bundle branches |
| E. SA node | |

Choose the correct sequence of pathway from the options given below

- (1) E-A-D-B-C
- (2) E-C-A-D-B
- (3) A-E-C-B-D
- (4) B-D-E-C-A

Answer (2)

Sol. Correct answer is option (2) because the correct pathway of conduction of action potential is

SA → AV node → AV bundle → Bundle branches → Purkinje fibres

156. Given below are two statements :

Statement I : In the nephron, the descending limb of loop of Henle is impermeable to water and permeable to electrolytes.

Statement II : The proximal convoluted tubule is lined by simple columnar brush border epithelium and increases the surface area for reabsorption.

In the light of the above statements, choose the correct answer from the option given below :

- (1) Statement I is false but Statement II is true
- (2) Both Statement I and Statement II are true
- (3) Both Statement I and Statement II are false
- (4) Statement I is true but Statement II is false

Answer (3)

Sol. Correct answer is option (3) because

Statement I is false as the descending limb of loop of Henle is permeable to water and almost impermeable to electrolytes.

Statement II is false as proximal convoluted tubule is lined by simple cuboidal brush border epithelium which increases the surface area for reabsorption.

157. Match List I with List II :

	List I		List II
A.	Down's syndrome	I.	11 th chromosome
B.	α -Thalassemia	II.	'X' chromosome
C.	β -Thalassemia	III.	21 st chromosome
D.	Klinefelter's syndrome	IV.	16 th chromosome

Choose the correct answer from the options given below :

- (1) A-IV, B-I, C-II, D-III
- (2) A-I, B-II, C-III, D-IV
- (3) A-II, B-III, C-IV, D-I
- (4) A-III, B-IV, C-I, D-II

Answer (4)

Sol. Down's syndrome is due to presence of an additional copy of chromosome number 21. Klinefelter's syndrome is caused due to presence of an additional copy of X-chromosome. α -Thalassemia is controlled by two closely linked genes on chromosome 16 of each parent. β -Thalassemia is controlled by a single gene HBB on chromosome 11 of each parent.

158. Given below are some stages of human evolution.

Arrange them in correct sequence. (Past to Recent)

- A. *Homo habilis*
- B. *Homo sapiens*
- C. *Homo neanderthalensis*
- D. *Homo erectus*

Choose the correct sequence of human evolution from the options given below:

- (1) A-D-C-B
- (2) D-A-C-B
- (3) B-A-D-C
- (4) C-B-D-A

Answer (1)

Sol. Correct answer is option (1) because the correct sequence of stages of human evolution from past to recent is

Homo habilis → *Homo erectus* → *Homo neanderthalensis* → *Homo sapiens*

159. The flippers of the Penguins and Dolphins are the example of the

- (1) Divergent evolution
- (2) Adaptive radiation
- (3) Natural selection
- (4) Convergent evolution

Answer (4)

Sol. The correct answer is option (4), because the flippers of the Penguins and Dolphins perform similar function but they are not anatomically similar structures. This is example of analogous structures.

- Option (1) is incorrect as divergent evolution results in the formation of homologous structures.
- Option (2) is incorrect as adaptive radiation is the process of evolution of different species in a given geographical area starting from a point and literally radiating to the other areas of geography.
- Option (3) is incorrect as natural selection is a key mechanism of evolution.

160. Match List I with List II :

	List I (Sub Phases of Prophase I)		List II (Specific Characters)
A.	Diakinesis	I.	Synaptonemal complex formation
B.	Pachytene	II.	Completion of terminalisation of chiasmata
C.	Zygotene	III.	Chromosomes look like thin threads
D.	Leptotene	IV.	Appearance of recombination nodules

Choose the correct answer from the options given below

- (1) A-IV, B-III, C-II, D-I
- (2) A-IV, B-II, C-III, D-I
- (3) A-I, B-II, C-IV, D-III
- (4) A-II, B-IV, C-I, D-III

Answer (4)

Sol. (A) Diakinesis – Completion of terminalisation of chiasmata

(B) Pachytene – Appearance of recombination nodules

(C) Zygotene – Synaptonemal complex formation

(D) Leptotene – Chromosomes look like thin threads

A-II, B-IV, C-I, D-III

161. Match List I with List II :

	List I		List II
A.	Typhoid	I.	Fungus
B.	Leishmaniasis	II.	Nematode
C.	Ringworm	III.	Protozoa
D.	Filariasis	IV.	Bacteria

Choose the correct answer from the options given below:

- (1) A-II, B-IV, C-III, D-I
- (2) A-I, B-III, C-II, D-IV
- (3) A-IV, B-III, C-I, D-II
- (4) A-III, B-I, C-IV, D-II

Answer (3)

Sol. The correct answer is option (3) as

Typhoid – Caused by *Salmonella typhimurium* (Bacteria)

Leishmaniasis – Caused by protozoan *i.e.*, *Leishmania donovani*

Ringworm – Caused by fungi belonging to the genera *Microsporium*, *Trichophyton* and *Epidermophyton*

Filariasis – Caused by *Wuchereria bancrofti* and *Wuchereria malayi* (Nematode)

162. Match List I with List II :

	List I		List II
A.	Pons	I.	Provides additional space for Neurons, regulates posture and balance.
B.	Hypothalamus	II.	Controls respiration and gastric secretions.
C.	Medulla	III.	Connects different regions of the brain.
D.	Cerebellum	IV.	Neuro secretory cells

Choose the correct answer from the options given below :

(1) A-II, B-I, C-III, D-IV

(2) A-II, B-III, C-I, D-IV

(3) A-III, B-IV, C-II, D-I

(4) A-I, B-III, C-II, D-IV

Answer (3)

Sol. The correct answer is option (3) as

A.	Pons	–	Part of hindbrain, it connects different regions of the brain.
B.	Hypothalamus	–	Also have neuro secretory cells which secrete hormones.
C.	Medulla oblongata	–	Part of hindbrain which controls respiration and gastric secretions.
D.	Cerebellum	–	Part of hindbrain with convoluted surface which provides additional space for neurons, also regulates posture and balance.

163. Which one is the correct product of DNA dependent RNA polymerase to the given template?

3'TACATGGCAAATATCCATTCA5'

(1) 5'ATGTACCGTTTATAGGTAAGT3'

(2) 5'AUGUACCGUUUUAUAGGUAAGU3'

(3) 5'AUGUAAAGUUUUAUAGGUAAGU3'

(4) 5'AUGUACCGUUUUAUAGGGAAGU3'

Answer (2)

Sol. Template DNA is :

3'TACATGGCAAATATCCATTCA5'

5'AUGUACCGUUUUAUAGGUAAGU3' m-RNA

164. Match List I with List II :

List I	List II
A. <i>Pterophyllum</i>	I. Hag fish
B. <i>Myxine</i>	II. Saw fish
C. <i>Pristis</i>	III. Angel fish
D. <i>Exocoetus</i>	IV. Flying fish

Choose the correct answer from the options given below :

- (1) A-III, B-II, C-I, D-IV
- (2) A-II, B-I, C-III, D-IV
- (3) A-III, B-I, C-II, D-IV
- (4) A-IV, B-I, C-II, D-III

Answer (3)

Sol. The correct option is option no. (3) as

Pterophyllum is the scientific name for Angel fish.

Myxine is the scientific name for Hag fish.

Pristis is the scientific name for Saw fish.

Exocoetus is the scientific name for Flying fish.

165. Consider the following statements :

- A. Annelids are true coelomates
- B. Poriferans are pseudocoelomates
- C. Aschelminthes are acoelomates
- D. Platyhelminthes are pseudocoelomates

Choose the correct answer from the options given below :

- (1) D only
- (2) B only
- (3) A only
- (4) C only

Answer (3)

Sol. The correct answer is option no. (3), because annelids are true coelomate animals. Options (1), (2) and (4) are incorrect because poriferans are acoelomates, aschelminthes are pseudocoelomates and platyhelminthes are acoelomates.

166. Match List I with List II :

List I

- A. Common cold
- B. Haemozoin
- C. Widal test
- D. Allergy

List II

- I. *Plasmodium*
- II. Typhoid
- III. Rhinoviruses
- IV. Dust mites

Choose the correct answer from the options given below :

- (1) A-IV, B-II, C-III, D-I
- (2) A-II, B-IV, C-III, D-I
- (3) A-I, B-III, C-II, D-IV
- (4) A-III, B-I, C-II, D-IV

Answer (4)

Sol. Correct answer is option (4) because

- Common cold is caused by Rhinoviruses
- Haemozoin is released in blood due to ruptured RBCs after *Plasmodium* infection.
- Widal test is used to confirm the typhoid fever.
- Allergy is caused due to dust mites.

167. Which of the following statements is incorrect?

- (1) Bio-reactors have an agitator system, an oxygen delivery system and foam control system
- (2) A bio-reactor provides optimal growth conditions for achieving the desired product
- (3) Most commonly used bio-reactors are of stirring type
- (4) Bio-reactors are used to produce small scale bacterial cultures

Answer (4)

Sol. Correct answer is option (4)

The statement (4) is incorrect because bioreactors are used for processing of large volumes (100 – 1000 litres) of culture.

Small volume cultures cannot yield appreciable quantities of products. To produce in large quantities the development of bioreactors is required.

168. Given below are two statements : one is labelled as Assertion A and the other is labelled as Reason R :

Assertion A : FSH acts upon ovarian follicles in female and Leydig cells in male.

Reason R : Growing ovarian follicles secrete estrogen in female while interstitial cells secrete androgen in male human being.

In the light of the above statements, choose the correct answer from the options given below :

- (1) A is false but R is true
- (2) Both A and R are true and R is the correct explanation of A
- (3) Both A and R are true but R is NOT the correct explanation of A
- (4) A is true but R is false

Answer (1)

Sol. The correct answer is option (1) as FSH is a gonadotropin affects ovarian follicles in females and causes their growth but in males LH affects Leydig cells leading to secretion of androgens.

Growing ovarian follicles secrete estrogen in females while interstitial cells secrete androgen in male human being.

Hence, Assertion is false and Reason is true.

169. Following are the stages of cell division :

- A. Gap 2 phase
- B. Cytokinesis
- C. Synthesis phase
- D. Karyokinesis
- E. Gap 1 phase

Choose the correct sequence of stages from the options given below :

- (1) E-C-A-D-B
- (2) C-E-D-A-B
- (3) E-B-D-A-C
- (4) B-D-E-A-C

Answer (1)

Sol. The correct sequence of stages of cell division is

Gap 1 phase → Synthesis phase → Gap 2 phase
 (E) (C) (A)
 → Karyokinesis → Cytokinesis
 (D) (B)

The correct sequence will be → E → C → A → D → B

170. Given below are two statements:

Statement I: The presence or absence of hymen is not a reliable indicator of virginity.

Statement II: The hymen is torn during the first coitus only.

In the light of the above statements, choose the correct answer from the options given below :

- (1) Statement I is false but Statement II is true
- (2) Both Statement I and Statement II are true
- (3) Both Statement I and Statement II are false
- (4) Statement I is true but Statement II is false

Answer (4)

Sol. The correct answer is option no. (4) because the presence or absence of hymen is not a reliable indicator of virginity because hymen can also be broken by a sudden jolt, insertion of a vaginal tampon, active participation in some sports and in some women the hymen persists even after coitus.

171. Which of the following is not a natural/traditional contraceptive method?

- (1) Vaults
- (2) Coitus interruptus
- (3) Periodic abstinence
- (4) Lactational amenorrhea

Answer (1)

Sol. The correct answer is option (1) as

Vault is a barrier method of contraception which is made of rubber that is inserted into the female reproductive tract to cover the cervix during the coitus.

- Option (2) is incorrect as coitus interruptus is a natural method of contraception in which male partner withdraws his penis from the vagina just before ejaculation so as to avoid insemination.
- Option (3) is incorrect as periodic abstinence is also a natural method of contraception in which couples avoid coitus during the fertile period.

Option (4) is incorrect as lactational amenorrhea is also a natural method of contraception which is based on the fact that ovulation and therefore the cycle do not occur during the period of intense lactational following parturition.

172. Match List I with List II :

List I	List II
A. Fibrous joints	I. Adjacent vertebrae, limited movement
B. Cartilaginous joints	II. Humerus and Pectoral girdle, rotational movement
C. Hinge joints	III. Skull, don't allow any movement
D. Ball and socket joints	IV. Knee, help in locomotion

Choose the correct answer from the options given below :

- (1) A-III, B-I, C-IV, D-II
- (2) A-IV, B-II, C-III, D-I
- (3) A-I, B-III, C-II, D-IV
- (4) A-II, B-III, C-I, D-IV

Answer (1)

Sol. The correct answer is option no. (1) as

- Fibrous joints do not allow any movement. This type of joint is shown by the flat skull bones which fuse end-to-end with the help of dense fibrous connective tissues in the form of sutures.
- Cartilaginous joint is present between the adjacent vertebrae in the vertebral column and this permits limited movements.
- Hinge joint is a type of synovial joint present in knee, help in locomotion
- Ball and socket joint is also a type of synovial joint present between humerus and pectoral girdle and allows rotational movement.

173. The following diagram showing restriction sites in *E. coli* cloning vector pBR322. Find the role of 'X' and 'Y' genes :

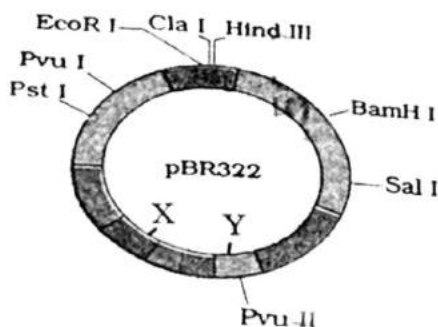

- (1) Gene 'X' is responsible for recognitions sites and 'Y' is responsible for antibiotic resistance.
- (2) The gene 'X' is responsible for resistance to antibiotics and 'Y' for protein involved in the replication of Plasmid.
- (3) The gene 'X' is responsible for controlling the copy number of the linked DNA and 'Y' for protein involved in the replication of Plasmid.
- (4) The gene 'X' is for protein involved in replication of Plasmid and 'Y' for resistance to antibiotics.

Answer (3)

Sol. Correct answer is option (3), because

'X' in the given diagram is *ori* while 'Y' is *rop*.

'X' which is *ori* is responsible for controlling the copy number of the linked DNA and 'Y' which is *rop* codes for protein involved in the replication of plasmid.

Options (1), (2) and (4) are incorrect as 'X' and 'Y' are not related to these functions.

174. Which of the following factors are favourable for the formation of oxyhaemoglobin in alveoli?

- (1) Low $p\text{CO}_2$ and High temperature
- (2) High $p\text{O}_2$ and High $p\text{CO}_2$
- (3) High $p\text{O}_2$ and Lesser H^+ concentration
- (4) Low $p\text{CO}_2$ and High H^+ concentration

Answer (3)

Sol. The correct answer is option (3) as

Conditions favourable for formation of oxyhaemoglobin in alveoli are high $p\text{O}_2$, less H^+ concentration low $p\text{CO}_2$ and low temperature.

Option (1), (2) and (4) are not correct as they do not favour the formation of oxyhaemoglobin.

175. In both sexes of cockroach, a pair of jointed filamentous structures called anal cerci are present on

- (1) 11th segment
- (2) 5th segment
- (3) 10th segment
- (4) 8th and 9th segment

Answer (3)

Sol. Correct answer is option (3), because in both sexes of cockroach, 10th segment bears a pair of jointed filamentous structures called anal cerci.

Options (1), (2), and (4) are incorrect because 5th, 8th and 9th segments do not bear such structures. In adult cockroaches only 10th segments are present in abdomen. 11th abdominal segment is absent.

176. Match **List I** with **List II**

	List I		List II
A.	Non-medicated IUD	I.	Multiload 375
B.	Copper releasing IUD	II.	Progestogens
C.	Hormone releasing IUD	III.	Lippes loop
D.	Implants	IV.	LNG-20

Choose the correct answer from the option given below:

(1) A-III, B-I, C-IV, D-II

(2) A-III, B-I, C-II, D-IV

(3) A-I, B-III, C-IV, D-II

(4) A-IV, B-I, C-II, D-III

Answer (1)

Sol. Correct answer is option (1) because

- Lippes loop is a non-medicated IUD.
- Multiload 375 is a copper releasing IUD.
- LNG -20 is a hormone releasing IUD.
- Progestogens are used as implants.

177. Match List I with List II :

	List I		List II
A.	Expiratory capacity	I.	Expiratory reserve volume + Tidal volume + Inspiratory reserve volume
B.	Functional residual capacity	II.	Tidal volume + Expiratory reserve volume
C.	Vital capacity	III.	Tidal volume + Inspiratory reserve volume
D.	Inspiratory capacity	IV.	Expiratory reserve volume + Residual volume

Choose the correct answer from the options given below :

(1) A-I, B-III, C-II, D-IV

(2) A-II, B-IV, C-I, D-III

(3) A-III, B-II, C-IV, D-I

(4) A-II, B-I, C-IV, D-III

Answer (2)

Sol. Expiratory capacity = Tidal volume + Expiratory reserve volume

Functional residual capacity = Expiratory reserve volume + Residual volume

Vital capacity = Expiratory reserve volume + Tidal volume + Inspiratory reserve volume

Inspiratory capacity = Tidal volume + Inspiratory reserve volume

178. Match List I with List II :

	List I		List II
A.	Pleurobrachia	I.	Mollusca
B.	Radula	II.	Ctenophora
C.	Stomochord	III.	Osteichthyes
D.	Air bladder	IV.	Hemichordata

Choose the correct answer from the options given below :

- (1) A-IV, B-III, C-II, D-I
- (2) A-IV, B-II, C-III, D-I
- (3) A-II, B-I, C-IV, D-III
- (4) A-II, B-IV, C-I, D-III

Answer (3)

Sol. The correct answer is option (3) as

- A. Pleurobrachia – is a member of phylum Ctenophora.
- B. Radula – is a rasping feeding organ present in phylum Mollusca.
- C. Stomochord – Rudimentary structure similar to notochord found in the collar region of members of phylum Hemichordata.
- D. Air bladder – is found in Osteichthyes which provides them buoyancy.

179. Which of the following are Autoimmune disorders?

- A. Myasthenia gravis
- B. Rheumatoid arthritis
- C. Gout
- D. Muscular dystrophy
- E. Systemic Lupus Erythematosus (SLE)

Choose the most appropriate answer from the options given below:

- (1) C, D & E only
- (2) A, B & D only
- (3) A, B & E only
- (4) B, C & E only

Answer (3)

Sol. The correct answer is option (3) as Myasthenia gravis, Rheumatoid arthritis and Systemic Lupus Erythematosus (SLE) are autoimmune disorders.

Muscular dystrophy is a genetic disorder which progressively affects the skeletal muscles.

Gout is the inflammation of joints due to deposition of uric acid crystals.

Option (1), (2) and (4) are not the correct answer because all of them are not autoimmune disorders.

180. Match List I with List II :

List I	List II
A. Cocaine	I. Effective sedative in surgery
B. Heroin	II. <i>Cannabis sativa</i>
C. Morphine	III. <i>Erythroxylum</i>
D. Marijuana	IV. <i>Papaver somniferum</i>

Choose the correct answer from the options given below:

- (1) A-III, B-IV, C-I, D-II
- (2) A-IV, B-III, C-I, D-II
- (3) A-I, B-III, C-II, D-IV
- (4) A-II, B-I, C-III, D-IV

Answer (1)

Sol. The correct option is (1) as

- A. Cocaine – Obtained from plant *Erythroxylum coca*, stimulating action on CNS.
- B. Heroin – Formed by the acetylation of morphine which is obtained from plant *Papaver somniferum*.
- C. Morphine – Obtained from *Papaver somniferum*, is an effective sedative in surgery.
- D. Marijuana – Obtained from *Cannabis sativa*, produces hallucinogenic effect and affects cardiovascular system of the body.

181. Match List I with List II :

List I	List II
A. Axoneme	I. Centriole
B. Cartwheel pattern	II. Cilia and flagella
C. Crista	III. Chromosome
D. Satellite	IV. Mitochondria

Choose the correct answer from the options given below :

- (1) A-II, B-I, C-IV, D-III
- (2) A-IV, B-III, C-II, D-I
- (3) A-IV, B-II, C-III, D-I
- (4) A-II, B-IV, C-I, D-III

Answer (1)

- Sol.**
- Axoneme is seen in cilia and flagella
 - Centriole shows cartwheel appearance
 - Crista is found in mitochondria
 - Satellite is present in chromosomes

182. Given below are two statements: One is labelled as Assertion A and the other is labelled as Reason R:

Assertion A : Breast-feeding during initial period of infant growth is recommended by doctors for bringing a healthy baby.

Reason R : Colostrum contains several antibodies absolutely essential to develop resistance for the new born baby.

In the light of the above statements, choose the most appropriate answer from the options given below:

- (1) A is not correct but R is correct
- (2) Both A and R are correct and R is the correct explanation of A
- (3) Both A and R are correct but R is NOT the correct explanation of A
- (4) A is correct but R is not correct

Answer (2)

Sol. Correct answer is option (2)

Breast-feeding during initial period of infant growth is recommended by doctors for bringing a healthy baby as colostrum contains several antibodies absolutely essential to develop resistance for the new born baby.

183. Three types of muscles are given as a, b and c. Identify the correct matching pair along with their location in human body:

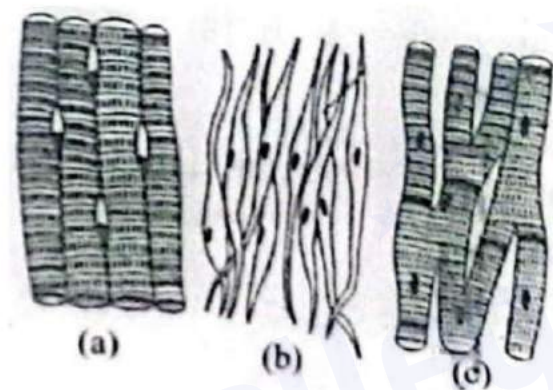

Name of muscle/location

- (1) (a) Involuntary – Nose tip
(b) Skeletal – Bone
(c) Cardiac – Heart
- (2) (a) Smooth - Toes
(b) Skeletal – Legs
(c) Cardiac – Heart
- (3) (a) Skeletal - Triceps
(b) Smooth – Stomach
(c) Cardiac – Heart
- (4) (a) Skeletal - Biceps
(b) Involuntary – Intestine
(c) Smooth – Heart

Answer (3)

Sol. The correct answer is option (3) as

Figure (a) represents skeletal muscle fibres which are closely attached to skeletal bones. In a typical muscle such as triceps and biceps, striated muscle fibres are bundled together in a parallel fashion.

Figure (b) represents smooth muscle fibres which are present in the wall of internal organs such as the blood vessels, stomach and intestine.

Figure (c) represents cardiac muscle fibres which are exclusively present in the heart.

184. Match List I with List II :

	List-I		List-II
A.	Lipase	I.	Peptide bond
B.	Nuclease	II.	Ester bond
C.	Protease	III.	Glycosidic bond
D.	Amylase	IV.	Phosphodiester bond

Choose the correct answer from the options given below :

(1) A-IV, B-I, C-III, D-II

(2) A-IV, B-II, C-III, D-I

(3) A-III, B-II, C-I, D-IV

(4) A-II, B-IV, C-I, D-III

Answer (4)

Sol. The correct answer is option (4) as

A.	Lipase	–	Digests ester bond found in lipids.
B.	Nuclease	–	Helps in digestion of phosphodiester bonds found in nucleic acids.
C.	Protease	–	Helps in digestion of peptide bond found in proteins.
D.	Amylase	–	Digests/breaks the glycosidic bonds found in carbohydrates i.e., digest starch into smaller molecules, ultimately yielding maltose, which in turn is cleaved into two glucose molecules by maltase.

185. Which of the following is not a steroid hormone?

(1) Glucagon

(2) Cortisol

(3) Testosterone

(4) Progesterone

Answer (1)

Sol. The correct answer is option (1) as glucagon is a proteinaceous hormone secreted from pancreas.

Options (2), (3) and (4) are not correct as they are steroid in nature.

SECTION-B

186. Regarding catalytic cycle of an enzyme action, select the correct sequential steps :

- A. Substrate enzyme complex formation.
- B. Free enzyme ready to bind with another substrate.
- C. Release of products.
- D. Chemical bonds of the substrate broken.
- E. Substrate binding to active site.

Choose the correct answer from the options given below :

- (1) E, D, C, B, A
- (2) E, A, D, C, B
- (3) A, E, B, D, C
- (4) B, A, C, D, E

Answer (2)

Sol. The correct answer is option (2) which is E, A, D, C, B.

The catalytic cycle of an enzyme action can be described in the following steps.

- (1) The enzyme releases the products of the reaction and the free enzyme is ready to bind to another molecule of the substrate and run through the catalytic cycle once again.
- (2) First, the substrate binds to the active site of the enzyme, fitting into the active site.
- (3) The binding of the substrate induces the enzyme to alter its shape, fitting more tightly around the substrate.
- (4) The active site of the enzyme, now in close proximity of the substrate breaks the chemical bonds of the substrate and the new enzyme-product complex is formed.

Options (1), (3) and (4) are incorrect as the steps mentioned are in the wrong sequence.

187. Given below are two statements :

Statement I : Bone marrow is the main lymphoid organ where all blood cells including lymphocytes are produced.

Statement II : Both bone marrow and thymus provide micro environments for the development and maturation of T-lymphocytes.

In the light of above statements, choose the most appropriate answer from the options given below :

- (1) Statement I is incorrect but Statement II is correct.
- (2) Both Statement I and Statement II are correct.
- (3) Both Statement I and Statement II are incorrect.
- (4) Statement I is correct but Statement II is incorrect.

Answer (2)

Sol. The correct answer is option no. (2) as both statements I and II are correct.

In humans, the bone marrow is the main lymphoid organ where all blood cells including lymphocytes are produced.

Both bone-marrow and thymus provide micro-environments for the development and maturation of T-lymphocytes.

Options (1), (3) and (4) are incorrect.

188. Match List I with List II :

	List I		List II
A.	Exophthalmic goiter	I.	Excess secretion of cortisol, moon face & hyperglycemia.
B.	Acromegaly	II.	Hypo-secretion of thyroid hormone and stunted growth.
C.	Cushing's syndrome	III.	Hyper secretion of thyroid hormone & protruding eye balls.
D.	Cretinism	IV.	Excessive secretion of growth hormone.

Choose the correct answer from the options given below :

- (1) A-III, B-IV, C-I, D-II
- (2) A-I, B-III, C-II, D-IV
- (3) A-IV, B-II, C-I, D-III
- (4) A-III, B-IV, C-II, D-I

Answer (1)

Sol. The correct answer is option no. (1) as

(A)	Exophthalmic goiter	(III)	Hyper secretion of thyroid hormone and characterized by protruding eye balls
(B)	Acromegaly	(IV)	Excessive secretion of growth hormone
(C)	Cushing's syndrome	(I)	Excess secretion of cortisol, moon face and hyperglycaemia
(D)	Cretinism	(II)	Hypo-secretion of thyroid hormone and characterized by stunted growth

189. Match List I with List II:

	List I		List II
A.	RNA polymerase III	I.	snRNPs
B.	Termination of transcription	II.	Promotor
C.	Splicing of Exons	III.	Rho factor
D.	TATA box	IV.	SnRNAs, tRNA

Choose the correct answer from the options given below :

- (1) A-IV, B-III, C-I, D-II
- (2) A-II, B-IV, C-I, D-III
- (3) A-III, B-II, C-IV, D-I
- (4) A-III, B-IV, C-I, D-II

Answer (1)

Sol. • In eukaryotes, RNA polymerase III codes for snRNAs, tRNA and 5s rRNA.

- Splicing of exons is performed by snRNPs.
- TATA box is present in promoter region of transcription unit.
- Rho factor is responsible for termination of transcription.

190. Given below are two statements:

Statement I: The cerebral hemispheres are connected by nerve tract known as corpus callosum.

Statement II: The brain stem consists of the medulla oblongata, pons and cerebrum.

In the light of the above statements, choose the most appropriate answer from the options given below:

- (1) Statement I is incorrect but Statement II is correct.
- (2) Both Statement I and Statement II are correct.
- (3) Both Statement I and Statement II are incorrect.
- (4) Statement I is correct but Statement II is incorrect.

Answer (4)

Sol. The correct answer is option (4) as statement I is correct but statement II is incorrect.

In human brain, a deep cleft divides the cerebrum longitudinally into two halves, which are termed as the left and right cerebral hemispheres. The cerebral hemispheres are connected by a tract of nerve fibres called corpus callosum.

Three major regions make up the brain stem *i.e.* mid brain, pons and medulla oblongata.

Cerebrum is a part of forebrain which does not form brain stem.

Options (1), (2) and (3) are incorrect.

191. Match List I with List II:

	List I		List II
A.	Unicellular glandular epithelium	I.	Salivary glands
B.	Compound epithelium	II.	Pancreas
C.	Multicellular glandular epithelium	III.	Goblet cells of alimentary canal
D.	Endocrine glandular epithelium	IV.	Moist surface of buccal cavity

Choose the correct answer from the options given below:

- (1) A-II, B-I, C-IV, D-III
- (2) A-II, B-I, C-III, D-IV
- (3) A-IV, B-III, C-I, D-II
- (4) A-III, B-IV, C-I, D-II

Answer (4)

Sol. The correct answer is option no. (4) as

- | | |
|---------------------------------------|---|
| A. Unicellular glandular epithelium | (III) Goblet cells of alimentary canal |
| B. Compound epithelium | (IV) Lines moist surface of buccal cavity |
| C. Multicellular glandular epithelium | (I) Salivary glands |
| D. Endocrine glandular epithelium | (II) Pancreas |

192. Match List I with List II:

	List I		List II
A.	Mesozoic Era	I.	Lower invertebrates
B.	Proterozoic Era	II.	Fish & Amphibia
C.	Cenozoic Era	III.	Birds & Reptiles
D.	Paleozoic Era	IV.	Mammals

Choose the correct answer from the options given below :

- (1) A-III, B-I, C-IV, D-II
- (2) A-II, B-I, C-III, D-IV
- (3) A-III, B-I, C-II, D-IV
- (4) A-I, B-II, C-IV, D-III

Answer (1)

Sol. The correct answer is option no. (1)

- | | | |
|---------------------|---|-------------------------|
| (A) Mesozoic Era | – | (III) Birds & Reptiles |
| (B) Proterozoic Era | – | (I) Lower invertebrates |
| (C) Cenozoic Era | – | (IV) Mammals |
| (D) Paleozoic Era | – | (II) Fish & Amphibia |

193. Given below are two statements:

Statement I: Mitochondria and chloroplasts both double membranes bound organelles.

Statement II: Inner membrane of mitochondria is relatively less permeable, as compared chloroplast.

In the light of the above statements, choose the mis appropriate answer from the options given below:

- (1) Statement I is incorrect but Statement II is correct.
- (2) Both Statement I and Statement II are correct.
- (3) Both Statement I and Statement II are incorrect.
- (4) Statement I is correct but Statement II is incorrect.

Answer (4)

Sol. Both mitochondria and chloroplasts are double membrane bound cell organelles.

Transport of ions occurs across the inner membrane of mitochondria. The inner membrane of chloroplast is impermeable to ions and metabolites. Therefore, it is said that inner membrane of mitochondria is relatively more permeable to that of chloroplast.

194. Match List I with List II related to digestive system of cockroach.

	List I		List II
A.	The structures used for storing of food	I.	Gizzard
B.	Ring of 6-8 blind tubules at junction of foregut and midgut.	II.	Gastric Caeca
C.	Ring of 100-150 yellow coloured thin filaments at junction of midgut and hindgut.	III.	Malpighian tubules
D.	The structures used for grinding the food.	IV.	Crop

Choose the correct answer from the options given below:

- (1) A-III, B-II, C-IV, D-I
- (2) A-IV, B-II, C-III, D-I
- (3) A-I, B-II, C-III, D-IV
- (4) A-IV, B-III, C-II, D-I

Answer (2)

Sol. The correct answer is option no. (2) as

The structure used for griding the food particles	–	Gizzard
The structure used for storing of food	–	Crop
Ring of 6-8 blind tubules at junction of foregut and midgut which assists in secretion of digestive juices	–	Gastric Caeca
Ring of 100-150 yellow coloured thin filaments at junction of midgut and hindgut which assists in elimination of nitrogenous wastes	–	Malpighian tubules

195. Given below are two statements:

Statement I: Gause's competitive exclusion principle states that two closely related species competing for different resources cannot exist indefinitely.

Statement II: According to Gause's principle, during competition, the inferior will be eliminated. This may be true if resources are limiting.

In the light of the above statements, choose the correct answer from the options given below :

- (1) Statement I is false but Statement II is true.
- (2) Both Statement I and Statement II are true.
- (3) Both Statement I and Statement II are false.
- (4) Statement I is true but Statement II is false.

Answer (1)

Sol. Gause's competitive exclusion principle states that two closely related species competing for the same resources cannot exist indefinitely and the competitively inferior one will be eliminated eventually. This may be true if resources are limiting.

196. The following are the statements about non-chordates:

- A. Pharynx is perforated by gill slits.
- B. Notochord is absent.
- C. Central nervous system is dorsal.
- D. Heart is dorsal if present.
- E. Post anal tail is absent.

Choose the most appropriate answer from the options given below:

- (1) B, C & D only
- (2) A & C only
- (3) A, B & D only
- (4) B, D & E only

Answer (4)

Sol. The correct answer is option no. (4) as the features of non-chordates among the given statements are:

- B. Notochord is absent.
- D. Heart is dorsal if present.
- E. Post anal tail is absent.

Statements A and C are features of chordates.

Hence, option (4) is correct and options (1), (2) and (3) are incorrect.

197. As per ABO blood grouping system, the blood group of father is B⁺, mother is A⁺ and child is O⁺. Their respective genotype can be

- | | |
|--|---|
| A. I ^B i/I ^A i/ii | B. I ^B I ^B /I ^A I ^A /ii |
| C. I ^A I ^B /iI ^A /I ^B i | D. I ^A i/I ^B i/I ^A i |
| E. ii/I ^B /iI ^A /I ^A I ^B | |

Choose the most appropriate answer from the options given below :

- (1) D & E only
- (2) A only
- (3) B only
- (4) C & B only

Answer (2)

Sol. Genotype of father with blood group B⁺ = I^Bi/ii^B
 Genotype of mother with blood group A⁺ = I^Ai/ii^A
 Genotype of child with blood group O⁺ = ii
 Hence only 'A' is correct.

198. Choose the correct statement given below regarding juxta medullary nephron.

- (1) Juxta medullary nephrons outnumber the cortical nephrons.
- (2) Juxta medullary nephrons are located in the columns of Bertini.
- (3) Renal corpuscle of juxta medullary nephron lies in the outer portion of the renal medulla.
- (4) Loop of Henle of juxta medullary nephron runs deep into medulla.

Answer (4)

Sol. The correct answer is option no, (4) because the length of loop of Henle of juxta medullary nephron is longer than the length of loop of Henle of cortical nephron and runs deep into medulla.

Option (1) is incorrect as juxta medullary nephrons are lesser in number than cortical nephrons.

Option (2) is incorrect as juxta medullary nephron are not present in columns of Bertini.

Option (3) is incorrect because renal corpuscle of juxta medullary nephron lies in inner cortical region.

199. Identify the correct option (A), (B), (C), (D) with respect to spermatogenesis.

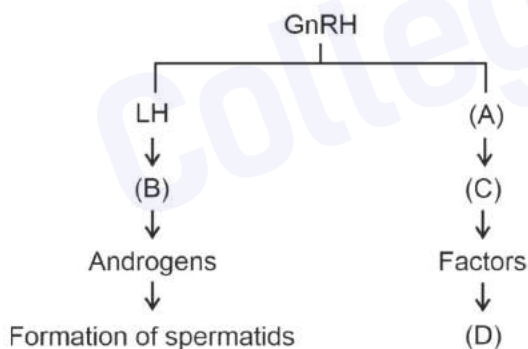

- (1) ICSH, Leydig cells, Sertoli cells, spermatogenesis.
- (2) FSH, Leydig cells, Sertoli cells, spermiogenesis.
- (3) ICSH, Interstitial cells, Leydig cells, spermiogenesis.
- (4) FSH, Sertoli cells, Leydig cells, spermatogenesis.

Answer (2)

Sol. The correct answer is option no. (2) as

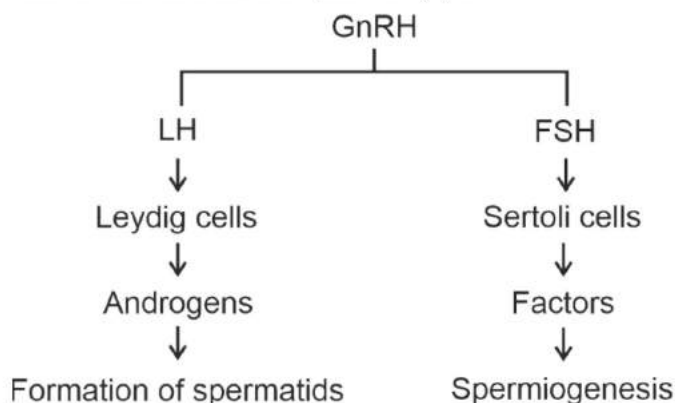

(A) is FSH which is a pituitary hormone.

(B) is Leydig cells which are found in the interstitial space outside of the seminiferous tubules.

(C) is Sertoli cells are found inside the seminiferous tubules.

(D) is Spermiogenesis which is a process that helps in transformation of spermatids into spermatozoa.

200.

Match List I with List II :

	List I		List II
A.	P wave	I.	Heart muscles are electrically silent.
B.	QRS complex	II.	Depolarisation of ventricles.
C.	T wave	III.	Depolarisation of atria.
D.	T-P gap	IV.	Repolarisation of ventricles.

Choose the correct answer from the options given below :

(1) A-IV, B-II, C-I, D-III

(2) A-I, B-III, C-IV, D-II

(3) A-III, B-II, C-IV, D-I

(4) A-II, B-III, C-I, D-IV

Answer (3)

Sol. The correct answer is option no. (3) as

A. P wave - III. Depolarisation of atria.

B. QRS complex - II. Depolarisation of ventricles.

C. T wave - IV. Repolarisation of ventricles.

D. T-P gap - I. Heart muscles are electrically silent.